



AQG BATHROOM & DESIGN, S.L
Carretera Almoradí - Rojas, Km 1
03160, Almoradí, Alicante, Spain
T: +34 865 753 000
ventas@aqgbathrooms.com

International Department
international@aqgbathrooms.com

www.aqgbathrooms.com



CATÁLOGO GENERAL / GENERAL CATALOGUE / CATALOGUE GÉNÉRAL / CATALOGO GENERALE / HAUPTKATALOG



CATÁLOGO GENERAL
GENERAL CATALOGUE
CATALOGUE GÉNÉRAL
CATALOGO GENERALE
HAUPTKATALOG

CATÁLOGO GENERAL
GENERAL CATALOGUE
CATALOGUE GÉNÉRAL
CATALOGO GENERALE
HAUPTKATALOG

ÍNDICE / INDEX / SOMMAIRE / INDICE / VERZEICHNIS

ENCIMERAS / COUNTERTOP BASINS PLANS VASQUES / PIANI LAVABO / WASCHTISCHE p. 28

 **MODELO / MODEL / MODÈLE**
MODELLO / MODELL
MILANO p. 30

 **MODELO / MODEL / MODÈLE**
MODELLO / MODELL
SIENA p. 42

 **MODELO / MODEL / MODÈLE**
MODELLO / MODELL
VERONA p. 54

 **MODELO / MODEL / MODÈLE**
MODELLO / MODELL
SICILIA p. 64

COLECTIVIDADES
COLECTIVITÉS / COLLECTIVITÉS
COLLETTIVITÀ / KOLLEKTIVITÄTEN
 **MODELO / MODEL / MODÈLE**
MODELLO / MODELL
SOLUTION p. 72

 **MODELO / MODEL / MODÈLE**
MODELLO / MODELL
BOLOGNA p. 36

 **MODELO / MODEL / MODÈLE**
MODELLO / MODELL
MARSELLA p. 48

 **MODELO / MODEL / MODÈLE**
MODELLO / MODELL
FIRENZE p. 60

 **MODELO / MODEL / MODÈLE**
MODELLO / MODELL
NAPOLI p. 68

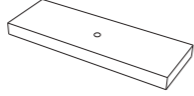
ENCIMERA PARA LAVABOS
COUNTERTOP FOR WASHBASIN / PLAN POUR VASQUES
PIANO PER LAVABI / KONSOLENPLATTE FÜR WASCHBECKEN
 **MODELO / MODEL / MODÈLE**
MODELLO / MODELL
BERGAMO p. 76

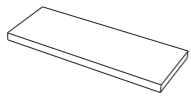
ESTANTES Y BALDAS
RACKS AND SHELVES
ÉTAGÈRES ET TABLETTES
SCAFFALI E RIPIANI
REGALE UND ABLAGEN
 p. 82

MUEBLE PARA ENCIMERA
METALLIC STRUCTURE
MEUBLE SOUS VASQUE
MOBILE PER PIANO LAVABO
MÖBELSTRUKTUR FÜR WASCHPLATTEN
 p. 88

LAVABOS / WASHBASINS VASQUES / LAVABI / WASCHBECKEN p. 96

 **MODELO / MODEL / MODÈLE**
MODELLO / MODELL
ARTEBA p. 98

 **MODELO / MODEL / MODÈLE**
MODELLO / MODELL
NIMES R p. 106

 **MODELO / MODEL / MODÈLE**
MODELLO / MODELL
CANNES p. 116

 **MODELO / MODEL / MODÈLE**
MODELLO / MODELL
NIMES E p. 102

 **MODELO / MODEL / MODÈLE**
MODELLO / MODELL
NICE p. 110

 **MODELO / MODEL / MODÈLE**
MODELLO / MODELL
MARSELLA p. 120

PLATOS DE DUCHA / SHOWER TRAYS RECEVEURS DE DOUCHE / PIATTI DOCCIA / DUSCHWANNEN p. 124

 **MODELO / MODEL / MODÈLE**
MODELLO / MODELL
SOFTUM p. 126

 **MODELO / MODEL / MODÈLE**
MODELLO / MODELL
FLAT p. 138

 **MODELO / MODEL / MODÈLE**
MODELLO / MODELL
STRUCT p. 148

 **MODELO / MODEL / MODÈLE**
MODELLO / MODELL
RATIO p. 160

 **MODELO / MODEL / MODÈLE**
MODELLO / MODELL
LUXE p. 132

 **MODELO / MODEL / MODÈLE**
MODELLO / MODELL
CLASSIC p. 142

 **MODELO / MODEL / MODÈLE**
MODELLO / MODELL
CENTRAL p. 154

PANELES DE REVESTIMIENTO WALL PANELS / PANNEAUX MURAUX PANNELI DI REVESTIMENTO / VERKLEIDUNGSPLETTEN

 p. 164

CONDICIONES GENERALES GENERAL CONDITIONS / CONDITIONS GÉNÉRALES CONDIZIONI GENERALI / ALLGEMEINE BEDINGUNGEN p. 174

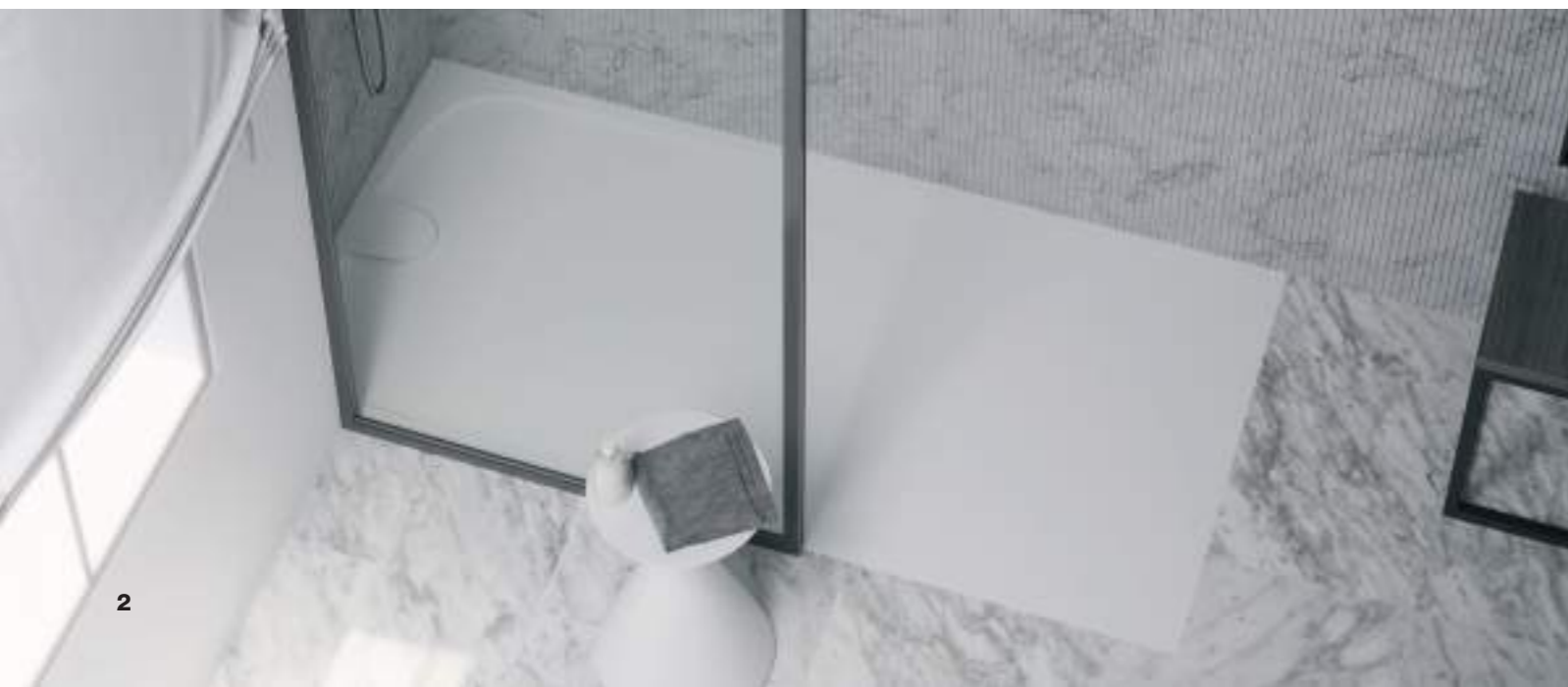



AQQ Bathrooms es la propuesta de productos de baño creada por el **Grupo AQQ**, referente español en soluciones de grifería para el mercado profesional, para reforzar su posicionamiento y brindar soluciones globales al sector sanitario.

Somos una empresa de ciclo completo que diseña, fabrica y comercializa una amplia gama de productos y soluciones para el equipamiento del baño. Platos de duchas extraplano y aligerados, paneles de revestimiento mural, lavamanos, encimeras y baldas, fabricados todos ellos, en su mayor parte, con materias primas de origen reciclado como prueba de nuestro alto grado de compromiso con la eco-sostenibilidad.

Contamos con un amplio equipo de profesionales con más de 20 años de trayectoria en el sector que, junto a la integración de todos nuestros procesos, posibilitan tener un alto grado de versatilidad para identificar y atender los requerimientos de nuestros clientes. Así, partimos de sus necesidades para desarrollar los mejores productos gracias a nuestro propio I+D, que trabaja en estrecho contacto con todos nuestros departamentos productivos para obtener la solución óptima para cada requerimiento, manteniendo un compromiso constante con la investigación en base a productos respetuosos con el medio ambiente.

Nuestra avanzada línea de producción automatizada, junto con una alta conciencia artesanal, posibilitan no solo un estricto control en la calidad de nuestros productos sino también una extraordinaria capacidad de desarrollar soluciones a medida cuando los proyectos de nuestros clientes así lo requieren. Es precisamente esta vocación por el trabajo bien hecho junto con procesos altamente flexibles, lo que nos convierte en la elección perfecta para cualquier demanda. Somos capaces de brindar un alto grado de personalización a todos nuestros productos, no sólo a través de una amplia gama de colores y texturas, sino ofreciendo también la posibilidad de adaptar o desarrollar el producto más adecuado para cada espacio. En cuanto a colores, además de la gama estándar ofrecemos la posibilidad de elegir cualquier otro de las cartas RAL y NCS además de nuestra exclusiva gama de acabados TECH y DECO, con los que se consigue imitar con altísima precisión, a través de un proceso de foto impresión digital de alta definición, una amplia variedad de acabados inspirados en la naturaleza.

Este nuevo catálogo se ha concebido como una herramienta ágil y práctica, e incorpora nuestros últimos desarrollos fruto de una permanente búsqueda de la excelencia.

Esperamos les sea de gran utilidad en todos sus nuevos proyectos.





AQQ Bathrooms is the proposal of bath products created by the **AQQ Group**, Spanish reference in faucet solutions for the professional market, to strengthen its positioning and provide global solutions to the sanitary sector.

We are a full cycle company that designs, manufactures and markets a wide range of products and solutions for bathroom equipment. Extra-flat and lightweight shower trays, wall panels, washbasins, countertop basins and shelves, all made from raw materials of recycled origin for the most part as proof of our high degree of commitment to eco-sustainability.

We have an extensive team of professionals with more than 20 years of experience in the sector that together with the integration of all our processes, allow us to have a high degree of versatility to identify and meet the requirements of our customers. Thus, we start with their needs to develop the best products thanks to our own R&D, which works in close contact with all our production departments to obtain the optimal solution for each requirement, maintaining a constant commitment to research based on environmentally friendly products.

Our advanced automated production line, together with a high artisanal awareness, allows not only strict control over the quality of our products, but also an extraordinary ability to develop tailor-made solutions when our customers' projects require it. It is precisely this vocation for work well done together with highly flexible processes that makes us the perfect choice for any demand, since we are able to provide a high degree of customization of all our products not only through a wide range of colors and textures, but also offering the possibility of adapting or developing the most suitable product for each space. In terms of colors, in addition to the standard range, we offer the possibility to choose any other of the RAL and NCS charts in addition to our exclusive range of TECH and DECO finishes that, through a high definition digital printing photo processing, achieve a great precision imitation of a wide variety of finishes inspired by nature.

This new catalogue has been conceived as an easy and practical tool, and incorporates our latest developments resulting from a permanent search for excellence.

We hope you will find it very useful in all your new projects.

AQQ Bathrooms est la proposition de produits de salle de bains créée par le **Groupe AQQ**, référence espagnole dans les solutions de robinetterie pour le marché professionnel, pour renforcer son positionnement et fournir des solutions globales au secteur sanitaire.

Nous sommes une société à cycle complet qui conçoit, fabrique et commercialise une large gamme de produits et de solutions pour l'équipement de salle de bains. Receveurs de douche extra-plats et légers, panneaux muraux, vasques, plans vasques et étagères, tous fabriqués à partir de matières premières d'origine recyclée pour la plupart comme preuve de notre haut degré d'engagement envers l'éco-durabilité.

Nous disposons d'une vaste équipe de professionnels avec plus de 20 ans d'expérience dans le secteur qui, avec l'intégration de tous nos processus, nous permettent d'avoir un haut degré de polyvalence pour identifier et répondre aux exigences de nos clients. Ainsi, nous partons de leurs besoins pour développer les meilleurs produits grâce à notre propre R&D, qui travaille en contact étroit avec tous nos départements de production pour obtenir la solution optimale pour chaque exigence, en maintenant un engagement constant à la recherche basée sur des produits respectueux de l'environnement.

Notre ligne avancée de production automatisée, associée à une grande conscience artisanale, permet non seulement un contrôle strict de la qualité de nos produits, mais aussi une capacité extraordinaire à développer des solutions sur mesure lorsque les projets de nos clients l'exigent. C'est précisément cette vocation de travail bien fait avec des processus très flexibles qui fait de nous le choix parfait pour toute demande, puisque nous sommes en mesure de fournir un haut degré de personnalisation de tous nos produits non seulement à travers une large gamme de couleurs et de textures, mais aussi offrant la possibilité d'adapter ou de développer le produit le plus approprié pour chaque espace. En termes de couleurs, en plus de la gamme standard, nous offrons la possibilité de choisir n'importe quel autre des nuanciers RAL et NCS en plus de notre gamme exclusive de finitions TECH et DECO, avec lesquelles vous pouvez imiter avec une grande précision, à travers un processus de photo impression digitale de haute définition, une grande variété de finitions inspirées de la nature.

Ce nouveau catalogue a été conçu comme un instrument agile et pratique, et intègre nos derniers développements résultants d'une recherche permanente d'excellence.

Nous espérons que vous le trouverez très utile dans tous vos nouveaux projets.



AQQ Bathrooms è la proposta di prodotti per il bagno creata dal **Gruppo AQQ**, riferimento spagnolo nelle soluzioni della robinetteria per il mercato professionale, per rafforzare il suo posizionamento e fornire soluzioni globali al settore sanitario.

Siamo una società a ciclo completo che progetta, produce e commercializza una vasta gamma di prodotti e soluzioni per gli elementi da bagno. Piatti di doccia extra-piatti e leggeri, pannelli di rivestimento murali, lavabi, piani lavabo e scaffali, tutti realizzati con materie prime di origine riciclata per la maggior parte come prova del nostro alto grado di impegno per l'eco-sostenibilità.

Abbiamo un ampio team di professionisti con oltre 20 anni di esperienza nel settore che, insieme all'integrazione di tutti i nostri processi, ci permettono di avere un alto grado di versatilità per identificare e soddisfare le esigenze dei nostri clienti. Così, partiamo dalle loro esigenze per sviluppare i migliori prodotti grazie al nostro proprio R+S, che lavora a stretto contatto con tutti i nostri divisioni di produzione per ottenere la soluzione ottimale per ogni esigenza, mantenendo un costante impegno nella ricerca basata su prodotti rispettosi dell'ambiente.

La nostra linea avanzata di produzione automatizzata, insieme ad un'elevata consapevolezza artigianale, consentono non solo un rigoroso controllo sulla qualità dei nostri prodotti, ma anche una straordinaria capacità di sviluppare soluzioni su misura quando i progetti dei nostri clienti lo richiedono. Proprio questa vocazione al lavoro ben fatto insieme a processi altamente flessibili ci rende la scelta perfetta per ogni domanda, dal momento che siamo in grado di fornire un alto livello di personalizzazione di tutti i nostri prodotti non solo attraverso una vasta gamma di colori e texture, ma anche offrendo la possibilità di adattare o sviluppare il prodotto più adatto per ogni spazio. In termini di colori, oltre alla gamma standard, offriamo la possibilità di scegliere qualsiasi altra delle carte RAL e NCS oltre alla nostra esclusiva gamma di finiture TECH e DECO, con cui è possibile imitare con grande precisione, attraverso un processo fotografico di stampa digitale ad alta definizione, una vasta gamma di finiture ispirate dalla natura.

Questo nuovo catalogo è stato concepito come uno strumento agile e pratico e incorpora i nostri recenti sviluppi derivati da una ricerca permanente di eccellenza.

Speriamo che lo troverete molto utile in tutti i vostri nuovi progetti.

AQQ Bathrooms ist der Vorschlag der **Gruppe AQQ**, spanische Referenzfirma für Lösungen in Armaturen für den professionellen Markt, um seine Positionierung zu stärken und globale Lösungen für den Sanitätssektor anzubieten.

Wir sind ein Vollzyklusunternehmen, das eine breite Palette von Produkten und Lösungen für die Badezimmerausstattung entwirft, herstellt und vermarktet. Extraflache und leichte Duschwannen, Verkleidungsplatten, Waschbecken, Waschtische und Regale, die zum größten Teil aus Rohstoffen recycelten Ursprungs hergestellt werden, sind ein Beweis für unser hohes Engagement für Öko-Nachhaltigkeit.

Wir verfügen über ein umfangreiches Team von Fachleuten mit mehr als 20 Jahren Erfahrung in der Branche, die zusammen mit der Integration aller unserer Prozesse es uns ermöglichen, ein hohes Maß an Vielseitigkeit zu haben, um die Anforderungen unserer Kunden zu identifizieren und zu erfüllen. So gehen wir von Ihren Bedürfnissen aus, die besten Produkte zu entwickeln, dank unserer eigenen F+E, die in engem Kontakt mit allen unseren Produktionsabteilungen arbeitet, um die optimale Lösung für jedes Bedürfnis zu erhalten, wobei ein ständiges Engagement für die Forschung auf der Grundlage umweltfreundlicher Produkte aufrechterhalten wird.

Unsere fortschrittliche automatisierte Produktionslinie, zusammen mit einem hohen handwerklichen Bewusstsein, ermöglichen nicht nur eine strenge Kontrolle über die Qualität unserer Produkte, sondern auch eine außergewöhnliche Fähigkeit, maßgeschneiderte Lösungen zu entwickeln, wenn die Projekte unserer Kunden es erfordern. Genau dieses Streben nach gut gemachter Arbeit in Verbindung mit hochflexiblen Prozessen macht uns zur perfekten Wahl für jede Nachfrage, da wir in der Lage sind, ein hohes Maß an Personalisierung aller unserer Produkte anzubieten, nicht nur durch eine breite Palette von Farben und Texturen, sondern wir liefern auch die Möglichkeit, das am besten geeignete Produkt für jeden Raum anzupassen oder zu entwickeln. In Bezug auf die Farben bieten wir zusätzlich zum Standardsortiment die Möglichkeit, jede andere aus der RAL und NCS Paletten zu wählen, zusätzlich zu unserem exklusiven Sortiment an TECH- und DECO-Oberflächen, die, durch ein High-Definition-Digital-Fotodruck-Verfahren, mit großer Präzision eine Vielzahl von Oberflächen, die von der Natur inspiriert sind, nachahmen können.

Dieser neue Katalog ist als schnelles und praktisches Hilfsmittel konzipiert und beinhaltet unsere neuesten Entwicklungen, die sich aus der permanenten Suche nach Exzellenz ergeben.

Wir hoffen, dass Sie es in allen Ihren neuen Projekten sehr nützlich finden.

**Una colección con elementos decorativos
inspirados en la naturaleza y en los materiales
de última tendencia.**

**A collection with decorative elements inspired in
nature as well as in the latest trends in materials.**

Una collezione con elementi decorativi ispirati alla
natura e nei materiali di ultima tendenza.

**Une collection avec des éléments décoratifs inspirés
de la nature et des matériaux dernière génération.**

Eine Sammlung mit dekorativen Elementen, die von der
Natur und von Materialien nach den neuesten Tendenzen
inspiriert sind.



**DARK
CEMENT**



**LIGHT
CEMENT**



**ORIGIN
OXIDE**



**IRON
OXIDE**



**BONE
STONE**



**GREY
STONE**



**IVORY
MARBLE**



**SILK
STONE**



**WHITE
MARBLE**



**SAND
STONE**



**BLACK
MARBLE**

A close-up view of a light-colored wood grain with a subtle, vertical texture, appearing slightly weathered or painted.

**ARTIC
WOOD**

A close-up view of a warm, golden-brown wood grain with a smooth, vertical texture.

**COLONIAL
WOOD**

A close-up view of a light gray wood grain with a subtle, vertical texture, appearing slightly weathered or painted.

**LIGHT
SHADOW
WOOD**

A close-up view of a medium-brown wood grain with a smooth, vertical texture.

**PROVENZAL
WOOD**

A close-up view of a light, warm wood grain with a smooth, vertical texture, featuring subtle variations in tone.

**SUNRISE
WOOD**

A close-up view of a dark, rich wood grain with a smooth, vertical texture, showing deep brown and black tones.

**BLACK
FOREST**

FABRICACIÓN A MEDIDA
CUSTOMIZED MANUFACTURE
FABRIQUE SUR MESURE
PRODUZIONE FATTA SU MISURA
FERTIGUNG NACH MAß

ACABADOS
FINISHES
FINITIONS
FINITURE
AUSFÜHRUNGEN



TECH



ORIGIN OXIDE



FABRICACIÓN A MEDIDA
CUSTOMIZED MANUFACTURE
FABRIQUE SUR MESURE
PRODUZIONE FATTA SU MISURA
FERTIGUNG NACH MAß

ACABADOS
FINISHES
FINITIONS
FINITURE
AUSFÜHRUNGEN



TECH



TECH



WHITE MARBLE

BLACK MARBLE



FABRICACIÓN A MEDIDA
CUSTOMIZED MANUFACTURE
FABRIQUE SUR MESURE
PRODUZIONE FATTA SU MISURA
FERTIGUNG NACH MAß

ACABADOS
FINISHES
FINITIONS
FINITURE
AUSFÜHRUNGEN



TECH



TECH

ARTIC WOOD



FABRICACIÓN A MEDIDA
CUSTOMIZED MANUFACTURE
FABRIQUE SUR MESURE
PRODUZIONE FATTA SU MISURA
FERTIGUNG NACH MAß

ACABADOS
FINISHES
FINITIONS
FINITURE
AUSFÜHRUNGEN



TECH



TECH

CEMENT LIGHT

CEMENT DARK





DECO

ACABADOS
FINISHES / FINITIONS
FINITURE / AUSFÜHRUNGEN

A collection with decorative elements inspired in nature as well as in the latest trends in materials.

Une collection avec des éléments décoratifs inspirés de la nature et des matériaux dernière génération.

Una colección con elementos decorativos inspirados en la naturaleza y en los materiales de última tendencia.

Una collezione con elementi decorativi ispirati alla natura e nei materiali di ultima tendenza.

Eine Sammlung mit dekorativen Elementen, die von der Natur und von Materialien nach den neuesten Tendenzen inspiriert sind.



TERRAZO
CREMA



TERRAZO
NEGRO



TERRAZO
MARRÓN



TERRAZO
GRIS



TERRAZO
ROJO



TERRAZO
BLANCO



TERRAZO
VERDE

FABRICACIÓN A MEDIDA
CUSTOMIZED MANUFACTURE
FABRIQUE SUR MESURE
PRODUZIONE FATTA SU MISURA
FERTIGUNG NACH MAß

ACABADOS
FINISHES
FINITIONS
FINITURE
AUSFÜHRUNGEN



DECO



TERRAZO GRIS



TERRAZO NEGRO



FABRICACIÓN A MEDIDA
CUSTOMIZED MANUFACTURE
FABRIQUE SUR MESURE
PRODUZIONE FATTA SU MISURA
FERTIGUNG NACH MAß

ACABADOS
FINISHES
FINITIONS
FINITURE
AUSFÜHRUNGEN



DECO



TERRAZO GRIS



TERRAZO NEGRO





ENCIMERAS
COUNTERTOP BASINS
PLANS VASQUES
PIANI LAVABO
WASCHTISCHE

FABRICACIÓN A MEDIDA
CUSTOMIZED MANUFACTURE
FABRIQUE SUR MESURE
PRODUZIONE FATTA SU MISURA
FERTIGUNG NACH MAß

ENCIMERA
COUNTERTOP BASIN
PLAN VASQUE
PIANO LAVABO
WASCHTISCH

MILANO



① MILANO

ENCIMERA
COUNTERTOP BASIN
PLAN VASQUE
PIANO LAVABO
WASCHTISCH

RAL: 9003

p. 30

② RATIO

PLATO DE DUCHA
SHOWER TRAY
RECEVEUR DE DOUCHE
PIATTO DOCCIA
DUSCHWANNE

REJILLA: LACADA
GRID: LACQUERED
GRILLE: LAQUÉE
GRIGLIA: LACCATA
ABLAUFGITTER: LACKIERT

RAL: 9003

p. 160

FABRICACIÓN A MEDIDA
CUSTOMIZED MANUFACTURE
FABRIQUE SUR MESURE
PRODUZIONE FATTA SU MISURA
FERTIGUNG NACH MAß

ENCIMERA
COUNTERTOP BASIN
PLAN VASQUE
PIANO LAVABO
WASCHTISCH

MILANO



FABRICACIÓN A MEDIDA
CUSTOMIZED MANUFACTURE
FABRIQUE SUR MESURE
PRODUZIONE FATTA SU MISURA
FERTIGUNG NACH MAß

ENCIMERA
COUNTERTOP BASIN
PLAN VASQUE
PIANO LAVABO
WASCHTISCH

MILANO



OPCIONES / OPTIONS / OPTIONS / OPZIONI / OPTIONEN

MEDIDAS SENO / WASH BASIN MEASURES
MESURES DE LA CUVE / MISURE DI LAVABO
WASCHBECKEN GRÖSSE

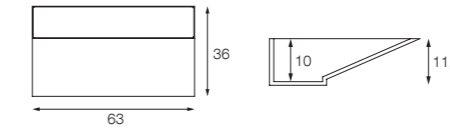

CORTE A MEDIDA / BESPOKE CUT
COUPE À MESURE / TAGLIO SU MISURA
SCHNITT NACH MAß

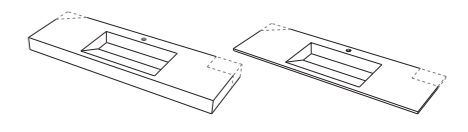

CON FALDONES O CONSOLA / WORKTOP WALL MOUNTED OR CONSOLE / AVEC TABLIER OU CONSOLE MURALE / PIANI LAVABO O CONSOLE / MIT WANDWASCHTISCH ODER KONSOLE

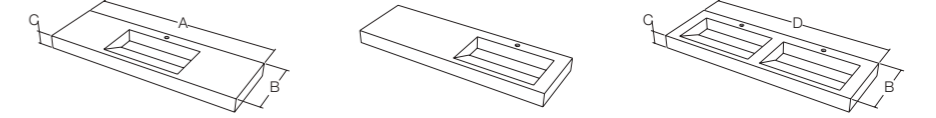

A = 83,5 - 221 cm B = 50 - 55 cm C = 12 - 15 cm D = 157 - 221 cm

SOBRE MUEBLE / COUNTERTOP BASIN / VASQUE SUR UN MEUBLE / LAVABI DA APPOGGIO / AUFSATZBECKEN AUF MÖBEL

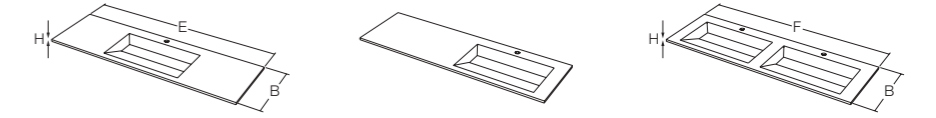

E = 77,5 - 221 cm B = 50 - 55 cm F = 151 - 221 cm H = 2 cm

TOALLERO FRONTAL O LATERAL / FRONTAL OR LATERAL TOWEL RAIL / PORTE-SERVIETTE FRONTAL OU LATÉRAL / PORTACIUGAMANI FRONTALE O LATERALE / VORDERER ODER SEITLICHER HANDTUCHHALTER

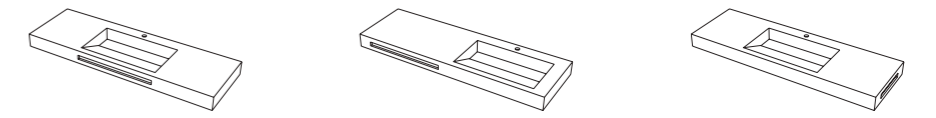

TOALLERO AQQ O ESTÁNDAR / AQQ OR STANDARD TOWEL RAIL / PORTE-SERVIETTE AQQ OU STANDARD / PORTACIUGAMANI AQQ O STANDARD / AQQ ODER STANDARD HANDTUCHHALTER

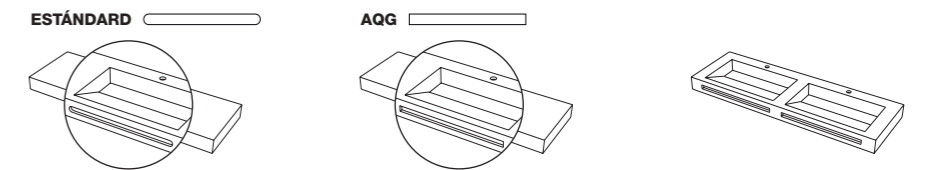

COPETE, REBOSADERO Y ORIFICIO PARA GRIFERÍA / TOPKNOT, OVERFLOW AND HOLE FOR FAUCETS / TOUPET, TROP-PLEIN ET TROU POUR ROBINETS / ALZATINE, TROPPO PIENO E FORO PER RUBINETTI / PROFIL, ÜBERLAUF UND ARMATURENLOCH

VÁLVULAS VALVES / VANNES
SCARICO / ABLAUFVENTILE

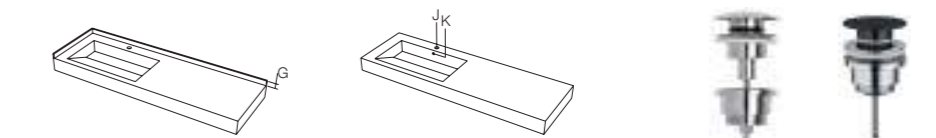

G = 5 - 10 cm J = Ø35 mm K = Ø30 mm

PROPIEDADES / PROPERTIES / PROPRIÉTÉS / CARATTERISTICHE / EIGENSCHAFTEN



garantía 3 años *
3 years guarantee *
garantie 3 ans *
garanzia 3 anni *
3 Jahre Garantie *



fácil limpieza
easy cleaning
nettoyage facile
facile pulizia
leichte Reinigung



ligero
light weight
léger
leggero
leichtgewichtig



masa pigmentada
pigmented mass
masse pigmentée
massa colorata
Pigmentmasse



hecho en España
made in Spain
fabriqué en Espagne
fatto in Spagna
in Spanien hergestellt



bacteriostático
bacteriostatic
bactériostatique
batteriostatico
bakterienhemmend



fácil instalación
easy installation
installation facile
facile installazione
einfache Installation



no absorbente
non-absorbent
non absorbant
non assorbente
nicht absorbierend



certificado
certicate
certifié
certificato
Zertifikat

* **extension de garantía opcional**
* optional warranty extension / * extension de garantie optionnelle
* estensione de garanzia opzionale / * optionale Garantieverlängerung

TEXTURAS / TEXTURES / TEXTURES / FINITURE / TEXTUREN



lisa
smooth
lisse
liscia
glatt



pizarra
slate
ardoise
ardesia
Schiefer



cemento
cement
ciment
cemento
Zement



madera
wood
bois
legno
Holz

COLORES Y ACABADOS / COLOURS AND FINISHES / COULEURS ET FINITIONS / COLORI E FINITURE / FARBEN UND AUSFÜHRUNGEN



RAL 9003



RAL 9001



colores NCS
NCS colours
couleurs NCS
colori NCS
NCS Farben



colores RAL
RAL colours
couleurs RAL
colori RAL
RAL Farben



acabados TECH
TECH finishes
finitions TECH
finiture TECH
TECH Ausführungen



acabados DECO
DECO finishes
finitions DECO
finiture DECO
DECO Ausführungen

FABRICACIÓN A MEDIDA
CUSTOMIZED MANUFACTURE
FABRIQUE SUR MESURE
PRODUZIONE FATTA SU MISURA
FERTIGUNG NACH MAß

ENCIMERA
COUNTERTOP BASIN
PLAN VASQUE
PIANO LAVABO
WASCHTISCH

BOLOGNA



1 BOLOGNA

ENCIMERA
COUNTERTOP BASIN
PLAN VASQUE
PIANO LAVABO
WASCHTISCH

RAL: 9003

p. 36

2 LUXE

PLATO DE DUCHA
SHOWER TRAY
RECEVEUR DE DOUCHE
PIATTO DOCCIA
DUSCHWANNE

REJILLA: ESTÁNDAR
GRID: STANDARD
GRILLE: STANDARD
GRIGLIA: STANDARD
ABLAUFGITTER: STANDARD

RAL: 9003

p. 132

BOLOGNA

ENCIMERA
COUNTERTOP BASIN
PLAN VASQUE
PIANO LAVABO
WASCHTISCH

FABRICACIÓN A MEDIDA
CUSTOMIZED MANUFACTURE
FABRIQUE SUR MESURE
PRODUZIONE FATTA SU MISURA
FERTIGUNG NACH MAß



FABRICACIÓN A MEDIDA
CUSTOMIZED MANUFACTURE
FABRIQUE SUR MESURE
PRODUZIONE FATTA SU MISURA
FERTIGUNG NACH MAß

ENCIMERA
COUNTERTOP BASIN
PLAN VASQUE
PIANO LAVABO
WASCHTISCH

BOLOGNA



OPCIONES / OPTIONS / OPTIONS / OPZIONI / OPTIONEN

MEDIDAS SENO / WASH BASIN MEASURES
MESURES DE LA CUVE / MISURE DI LAVABO
WASCHBECKEN GRÖSSE

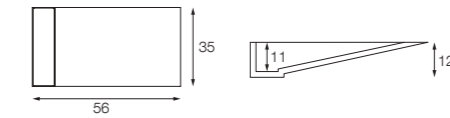

CORTE A MEDIDA / BESPOKE CUT
COUPE À MESURE / TAGLIO SU MISURA
SCHNITT NACH MAß

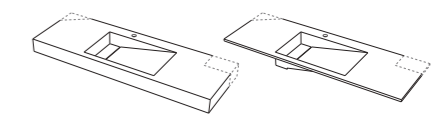

CON FALDONES O CONSOLA / WORKTOP WALL MOUNTED OR CONSOLE / AVEC TABLIER OU CONSOLE MURALE / PIANI LAVABO O CONSOLE / MIT WANDWASCHTISCH ODER KONSOLE

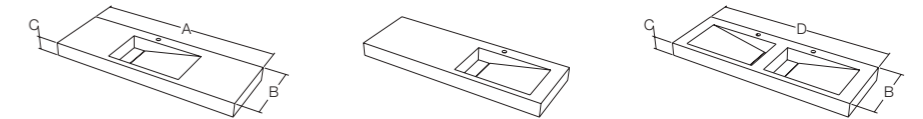

A = 76 - 221 cm B = 50 - 55 cm C = 12 - 15 cm D = 146 - 221 cm

SOBRE MUEBLE / COUNTERTOP BASIN / VASQUE SUR UN MEUBLE / LAVABI DA APPOGGIO / AUFSATZBECKEN AUF MÖBEL

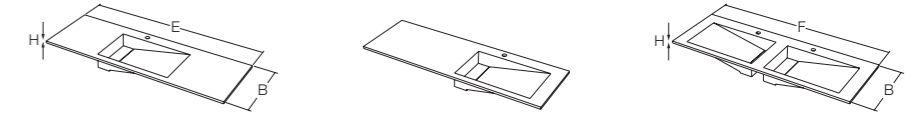

E = 72 - 221 cm B = 50 - 55 cm F = 140 - 221 cm H = 2 cm

TOALLERO FRONTAL O LATERAL / FRONTAL OR LATERAL TOWEL RAIL / PORTE-SERVIETTE FRONTAL OU LATÉRAL / PORTASCIUGAMANI FRONTALE O LATERALE / VORDERER ODER SEITLICHER HANDTUCHHALTER

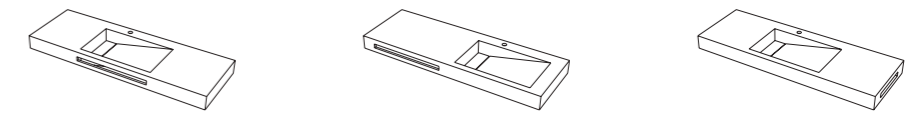

TOALLERO AQQ O ESTÁNDAR / AQQ OR STANDARD TOWEL RAIL / PORTE-SERVIETTE AQQ OU STANDARD / PORTASCIUGAMANI AQQ O STANDARD / AQQ ODER STANDARD HANDTUCHHALTER

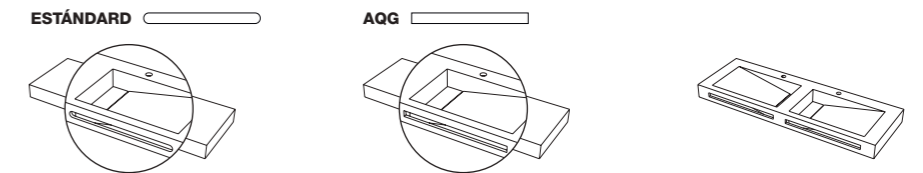

COPETE, REBOSADERO Y ORIFICIO PARA GRIFERÍA / TOPKNOT, OVERFLOW AND HOLE FOR FAUCETS / TOUPET, TROP-PLEIN ET TROU POUR ROBINETS / ALZATINE, TROPPO PIENO E FORO PER RUBINETTI / PROFIL, ÜBERLAUF UND ARMATURENLOCH

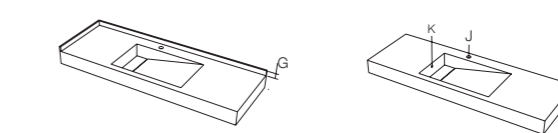

G = 5 - 10 cm J = Ø35 mm K = Ø30 mm

VÁLVULAS VALVES / VANNES
SCARICO / ABLAUFVENTILE



PROPIEDADES / PROPERTIES / PROPRIÉTÉS / CARATTERISTICHE / EIGENSCHAFTEN

garantía 3 años *
3 years guarantee *
garantie 3 ans *
garanzia 3 anni *
3 Jahre Garantie *

fácil limpieza
easy cleaning
nettoyage facile
facile pulizia
leichte Reinigung

ligero
light weight
léger
leggero
leichtgewichtig

masa pigmentada
pigmented mass
masse pigmentée
massa colorata
Pigmentmasse

hecho en España
made in Spain
fabriqué en Espagne
fatto in Spagna
in Spanien hergestellt

bacteriostático
bacteriostatic
bactériostatique
batteriostatico
bakterienhemmend

fácil instalación
easy installation
installation facile
facile installazione
einfache Installation

no absorbente
non-absorbent
non absorbant
non assorbente
nicht absorbierend

certificado
certicate
certifié
certificato
Zertifikat

* extension de garantía opcional
* optional warranty extension / * extension de garantie optionnelle
* estensione de garanzia opzionale / * optionale Garantieverlängerung

TEXTURAS / TEXTURES / TEXTURES / FINITURE / TEXTUREN



lisa
smooth
lisse
liscia
glatt



pizarra
slate
ardoise
ardesia
Schiefer



cemento
cement
ciment
cemento
Zement



madera
wood
bois
legno
Holz

COLORES Y ACABADOS / COLOURS AND FINISHES / COULEURS ET FINITIONS / COLORI E FINITURE / FARBEN UND AUSFÜHRUNGEN



RAL 9003



RAL 9001



colores NCS
NCS colours
couleurs NCS
colori NCS
NCS Farben



colores RAL
RAL colours
couleurs RAL
colori RAL
RAL Farben



acabados TECH
TECH finishes
finitions TECH
finiture TECH
TECH Ausführungen



acabados DECO
DECO finishes
finitions DECO
finiture DECO
DECO Ausführungen

FABRICACIÓN A MEDIDA
CUSTOMIZED MANUFACTURE
FABRIQUE SUR MESURE
PRODUZIONE FATTA SU MISURA
FERTIGUNG NACH MAß

ENCIMERA
COUNTERTOP BASIN
PLAN VASQUE
PIANO LAVABO
WASCHTISCH

SIENA



1 SIENA

ENCIMERA
COUNTERTOP BASIN
PLAN VASQUE
PIANO LAVABO
WASCHTISCH

RAL: 9005

p. 42

2 CLASSIC

PLATO DE DUCHA
SHOWER TRAY
RECEVEUR DE DOUCHE
PIATTO DOCCIA
DUSCHWANNE

REJILLA: LACADA
GRID: LAQUERED
GRILLE: LAQUÉE
GRIGLIA: LACCATA
ABLAUGITTER: LACKIERT

RAL: 9005

p. 142

3 EXOS P

MUEBLE PARA ENCIMERA
METALLIC STRUCTURE
MEUBLE SOUS VASQUE
MOBILE PER PIANO LAVABO
MÖBELSTRUKTUR FÜR WASCHPLATTEN

COLOR: NEGRO / BLACK

p. 90

SIENA

ENCIMERA
COUNTERTOP BASIN
PLAN VASQUE
PIANO LAVABO
WASCHTISCH

FABRICACIÓN A MEDIDA
CUSTOMIZED MANUFACTURE
FABRIQUE SUR MESURE
PRODUZIONE FATTA SU MISURA
FERTIGUNG NACH MAß



FABRICACIÓN A MEDIDA
CUSTOMIZED MANUFACTURE
FABRIQUE SUR MESURE
PRODUZIONE FATTA SU MISURA
FERTIGUNG NACH MAß

ENCIMERA
COUNTERTOP BASIN
PLAN VASQUE
PIANO LAVABO
WASCHTISCH

SIENA



PROPIEDADES / PROPERTIES / PROPRIÉTÉS / CARATTERISTICHE / EIGENSCHAFTEN

garantía 3 años *
3 years guarantee *
garanzia 3 anni *
3 Jahre Garantie *

fácil limpieza
easy cleaning
nettoyage facile
facile pulizia
leichte Reinigung

ligero
light weight
léger
leggero
leichtgewichtig

masa pigmentada
pigmented mass
masse pigmentée
massa colorata
Pigmentmasse

hecho en España
made in Spain
fabriqué en Espagne
fatto in Spagna
in Spanien hergestellt

bacteriostático
bacteriostatic
bactériostatique
batteriostatico
bakterienhemmend

fácil instalación
easy installation
installation facile
facile installazione
einfache Installation

no absorbente
non-absorbent
non absorbant
non assorbente
nicht absorbierend

certificado
certicate
certifié
certificato
Zertifikat

* **extension de garantía opcional**
* optional warranty extension / * extension de garantie optionnelle
* estensione de garanzia opzionale / * optionale Garantieverlängerung

TEXTURAS / TEXTURES / TEXTURES / FINITURE / TEXTUREN



lisa
smooth
lisse
liscia
glatt



pizarra
slate
ardoise
ardesia
Schiefer



cemento
cement
ciment
cemento
Zement



madera
wood
bois
legno
Holz

COLORES Y ACABADOS / COLOURS AND FINISHES / COULEURS ET FINITIONS / COLORI E FINITURE / FARBEN UND AUSFÜHRUNGEN



RAL 9003



RAL 9001



NATURAL COLOUR SYSTEM



RAL 7035



RAL 7044

colores NCS
NCS colours
couleurs NCS
colori NCS
NCS Farben

colores RAL
RAL colours
couleurs RAL
colori RAL
RAL Farben

acabados TECH
TECH finishes
finitions TECH
finiture TECH
TECH Ausführungen

acabados DECO
DECO finishes
finitions DECO
finiture DECO
DECO Ausführungen

OPCIONES / OPTIONS / OPTIONS / OPZIONI / OPTIONEN

MEDIDAS SENO / WASH BASIN MEASURES
MESURES DE LA CUVE / MISURE DI LAVABO
WASCHBECKEN GRÖSSE

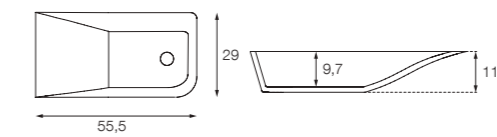

CORTE A MEDIDA / BESPOKE CUT
COUPE À MESURE / TAGLIO SU MISURA
SCHNITT NACH MAß

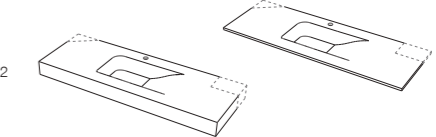

CON FALDONES O CONSOLA / WORKTOP WALL MOUNTED OR CONSOLE / AVEC TABLIER OU CONSOLE MURALE / PIANI LAVABO O CONSOLE / MIT WANDWASCHTISCH ODER KONSÖLE

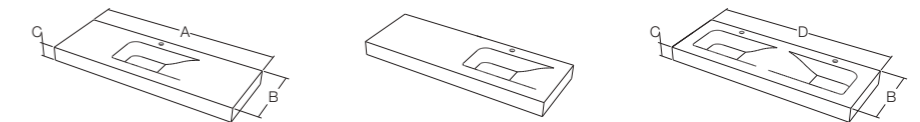

A = 78 - 221 cm B = 46 - 51 cm C = 12 - 15 cm D = 146 - 221 cm

SOBRE MUEBLE / COUNTERTOP BASIN / VASQUE SUR UN MEUBLE / LAVABI DA APPOGGIO / AUFSATZBECKEN AUF MÖBEL

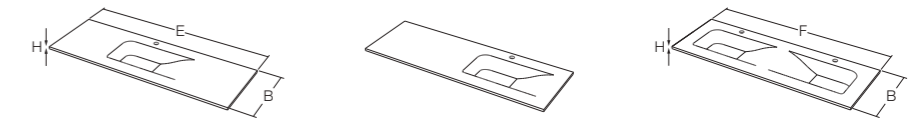

E = 72 - 221 cm B = 46 - 51 cm F = 140 - 221 cm H = 2 cm

TOALLERO FRONTAL O LATERAL / FRONTAL OR LATERAL TOWEL RAIL / PORTE-SERVIETTE FRONTAL OU LATÉRAL / PORTACIUGAMANI FRONTALE O LATERALE / VORDERER ODER SEITLICHER HANDTUCHHALTER

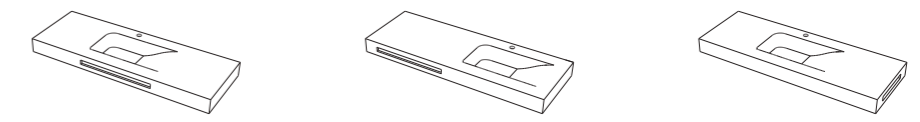

TOALLERO AQQ O ESTÁNDAR / AQQ OR STANDARD TOWEL RAIL / PORTE-SERVIETTE AQQ OU STANDARD / PORTACIUGAMANI AQQ O STANDARD / AQQ ODER STANDARD HANDTUCHHALTER

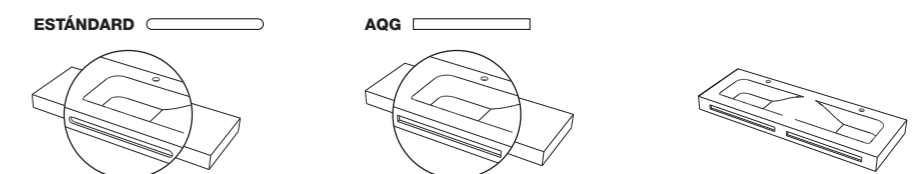

COPETE, REBOSADERO Y ORIFICIO PARA GRIFERÍA / TOPKNOT, OVERFLOW AND HOLE FOR FAUCETS / TOUPET, TROP-PLEIN ET TROU POUR ROBINETS / ALZATINE, TROPPO PIENO E FORO PER RUBINETTI / PROFIL, ÜBERLAUF UND ARMATURENLOCH

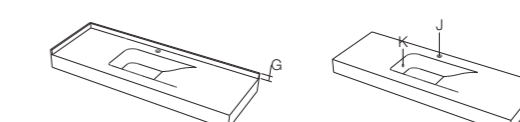

G = 5 - 10 cm J = Ø35 mm K = Ø30 mm

VÁLVULAS VALVES / VANNES
SCARICO / ABLAUFVENTILE



MARSELLA

ENCIMERA
COUNTERTOP BASIN
PLAN VASQUE
PIANO LAVABO
WASCHTISCH

FABRICACIÓN A MEDIDA
CUSTOMIZED MANUFACTURE
FABRIQUE SUR MESURE
PRODUZIONE FATTA SU MISURA
FERTIGUNG NACH MAß

①

① MARSELLA

ENCIMERA
COUNTERTOP BASIN
PLAN VASQUE
PIANO LAVABO
WASCHTISCH

RAL: 9003

p. 48

② SOFTUM

PLATO DE DUCHA
SHOWER TRAY
RECEVEUR DE DOUCHE
PIATTO DOCCIA
DUSCHWANNE

RAL: 9005

p. 126

②

MARSELLA

ENCIMERA
COUNTERTOP BASIN
PLAN VASQUE
PIANO LAVABO
WASCHTISCH

FABRICACIÓN A MEDIDA
CUSTOMIZED MANUFACTURE
FABRIQUE SUR MESURE
PRODUZIONE FATTA SU MISURA
FERTIGUNG NACH MAß





OPCIONES / OPTIONS / OPTIONS / OPZIONI / OPTIONEN

MEDIDAS SENO / WASH BASIN MEASURES
MESURES DE LA CUVE / MISURE DI LAVABO
WASCHBECKEN GRÖSSE

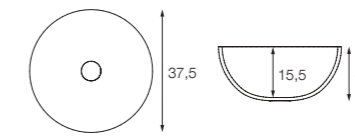

CORTE A MEDIDA / BESPOKE CUT
COUPE À MESURE / TAGLIO SU MISURA
SCHNITT NACH MAß

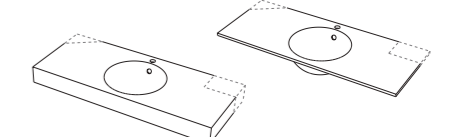

CON FALDONES O CONSOLA / WORKTOP WALL MOUNTED OR CONSOLE / AVEC TABLIER OU CONSOLE MURALE / PIANI LAVABO O CONSOLE / MIT WANDWASCHTISCH ODER KONSÖLE

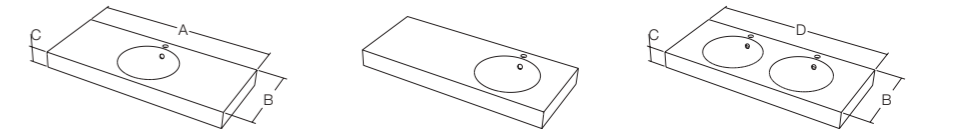

A = 66 - 221 cm B = 46 - 51 cm C = 12 - 18 cm D = 122 - 221 cm

SOBRE MUEBLE / COUNTERTOP BASIN / VASQUE SUR UN MEUBLE / LAVABI DA APPOGGIO / AUFSATZBECKEN AUF MÖBEL

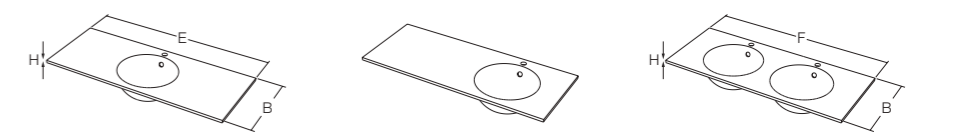

E = 60 - 221 cm B = 46 - 51 cm F = 116 - 221 cm H = 2 cm

TOALLERO FRONTAL O LATERAL / FRONTAL OR LATERAL TOWEL RAIL / PORTE-SERVIETTE FRONTAL OU LATÉRAL / PORTACIUGAMANI FRONTALE O LATERALE / VORDERER ODER SEITLICHER HANDTUCHHALTER

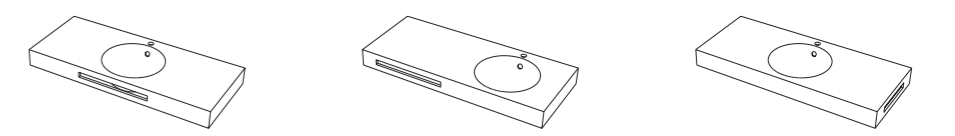

TOALLERO AQQ O ESTÁNDAR / AQQ OR STANDARD TOWEL RAIL / PORTE-SERVIETTE AQQ OU STANDARD / PORTACIUGAMANI AQQ O STANDARD / AQQ ODER STANDARD HANDTUCHHALTER

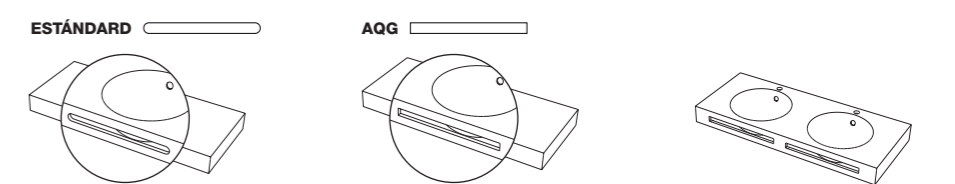

COPETE, REBOSADERO Y ORIFICIO PARA GRIFERÍA / TOPKNOT, OVERFLOW AND HOLE FOR FAUCETS / TOUPET, TROP-PLEIN ET TROU POUR ROBINETS / ALZATINE, TROPPO PIENO E FORO PER RUBINETTI / PROFIL, ÜBERLAUF UND ARMATURENLOCH

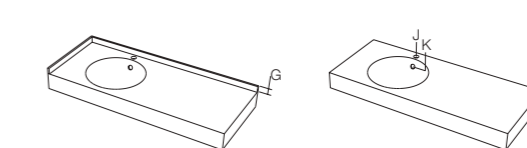

G = 5 - 10 cm J = Ø35 mm K = Ø30 mm

VÁLVULAS VALVES / VANNES
SCARICO / ABLAUFVENTILE



PROPIEDADES / PROPERTIES / PROPRIÉTÉS / CARATTERISTICHE / EIGENSCHAFTEN

garantía 3 años *
3 years guarantee *
garantie 3 ans *
garanzia 3 anni *
3 Jahre Garantie *

fácil limpieza
easy cleaning
nettoyage facile
facile pulizia
leichte Reinigung

ligero
light weight
léger
leggero
leichtgewichtig

masa pigmentada
pigmented mass
masse pigmentée
massa colorata
Pigmentmasse

hecho en España
made in Spain
fabriqué en Espagne
fatto in Spagna
in Spanien hergestellt

bacteriostático
bacteriostatic
bactériostatique
batteriostatico
bakterienhemmend

fácil instalación
easy installation
installation facile
facile installazione
einfache Installation

no absorbente
non-absorbent
non absorbant
non assorbente
nicht absorbierend

certificado
certificat
certifié
certificato
Zertifikat

* extension de garantía opcional
* optional warranty extension / * extension de garantie optionnelle
* estensione de garanzia opzionale / * optionale Garantieverlängerung

TEXTURAS / TEXTURES / TEXTURES / FINITURE / TEXTUREN



lisa
smooth
lisse
liscia
glatt



pizarra
slate
ardoise
ardesia
Schiefer



cemento
cement
ciment
cemento
Zement



madera
wood
bois
legno
Holz

COLORES Y ACABADOS / COLOURS AND FINISHES / COULEURS ET FINITIONS / COLORI E FINITURE / FARBEN UND AUSFÜHRUNGEN



RAL 9003



RAL 9001



colores NCS
NCS colours
couleurs NCS
colori NCS
NCS Farben



colores RAL
RAL colours
couleurs RAL
colori RAL
RAL Farben



acabados TECH
TECH finishes
finitions TECH
finiture TECH
TECH Ausführungen



acabados DECO
DECO finishes
finitions DECO
finiture DECO
DECO Ausführungen

FABRICACIÓN A MEDIDA
CUSTOMIZED MANUFACTURE
FABRIQUE SUR MESURE
PRODUZIONE FATTA SU MISURA
FERTIGUNG NACH MAß

ENCIMERA
COUNTERTOP BASIN
PLAN VASQUE
PIANO LAVABO
WASCHTISCH

VERONA

54



1 VERONA

ENCIMERA
COUNTERTOP BASIN
PLAN VASQUE
PIANO LAVABO
WASCHTISCH

RAL: 9003

p. 54

2 BALDA

BALDA
SHELF
TABLETTE
RIPIANO
ABLAGE

TECH COLOUR: PROVENZAL WOOD

p. 84

3 STRUCT

PLATO DE DUCHA
SHOWER TRAY
RECEVEUR DE DOUCHE
PIATTO DOCCIA
DUSCHWANNE

RAL: 9003

p. 148

55



FABRICACIÓN A MEDIDA
CUSTOMIZED MANUFACTURE
FABRIQUE SUR MESURE
PRODUZIONE FATTA SU MISURA
FERTIGUNG NACH MAß

ENCIMERA
COUNTERTOP BASIN
PLAN VASQUE
PIANO LAVABO
WASCHTISCH

VERONA

56



57

FABRICACIÓN A MEDIDA
CUSTOMIZED MANUFACTURE
FABRIQUE SUR MESURE
PRODUZIONE FATTA SU MISURA
FERTIGUNG NACH MAß

ENCIMERA
COUNTERTOP BASIN
PIANO VASQUE
PIANO LAVABO
WASCHTISCH

VERONA



OPCIONES / OPTIONS / OPTIONS / OPZIONI / OPTIONEN

MEDIDAS SENO / WASH BASIN MEASURES
MESURES DE LA CUVE / MISURE DI LAVABO
WASCHBECKEN GRÖSSE

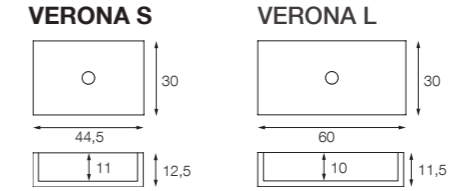

CORTE A MEDIDA / BESPOKE CUT
COUPE À MESURE / TAGLIO SU MISURA
SCHNITT NACH MAß

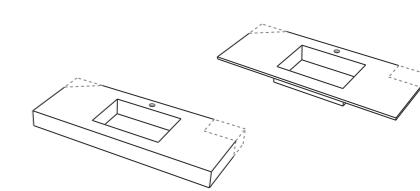

CON FALDONES O CONSOLA / WORKTOP WALL MOUNTED OR CONSOLE / AVEC TABLIER OU
CONSOLE MURALE / PIANI LAVABO O CONSOLE / MIT WANDWASCHTISCH ODER KÖNSOLE

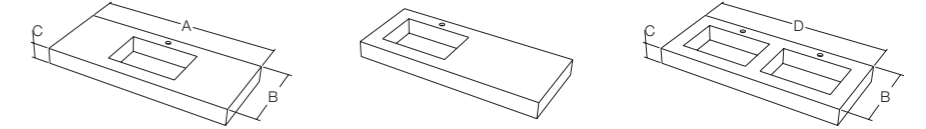

VERONA S: A = 64 - 221 cm B = 46 - 51 cm C = 12 - 15 cm D = 118 - 221 cm
VERONA L: A = 66 - 221 cm B = 46 - 51 cm C = 12 - 15 cm D = 122 - 221 cm

SOBRE MUEBLE / COUNTERTOP BASIN / VASQUE SUR UN MEUBLE / LAVABI DA APPOGGIO /
AUFSATZBECKEN AUF MÖBEL

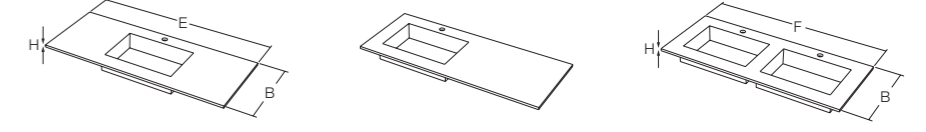

VERONA S: E = 58 - 221 cm B = 46 - 51 cm F = 112 - 221 cm H = 2 cm
VERONA L: E = 60 - 221 cm B = 46 - 51 cm F = 116 - 221 cm H = 2 cm

TOALLERO FRONTAL O LATERAL / FRONTAL OR LATERAL TOWEL RAIL / PORTE-SERVIETTE
FRONTAL OU LATÉRAL / PORTACIUGAMANI FRONTALE O LATÉRALE / VORDERER ODER SEITLICHER
HANDTUCHHALTER

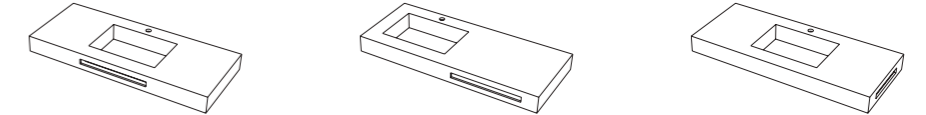

TOALLERO AQQ O ESTÁNDAR / AQQ OR STANDARD TOWEL RAIL / PORTE-SERVIETTE AQQ OU
STANDARD / PORTACIUGAMANI AQQ O STANDARD / AQQ ODER STANDARD HANDTUCHHALTER

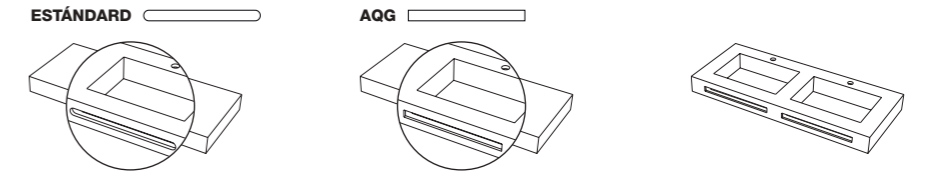

COPETE, REBOSADERO Y ORIFICIO PARA GRIFERÍA / TOPKNOT,
OVERFLOW AND HOLE FOR FAUCETS / TOUPET, TROP-PLEIN ET
TROU POUR ROBINETS / ALZATINE, TROPPO PIENO E FORO PER
RUBINETTI / PROFIL, ÜBERLAUF UND ARMATURENLOCH

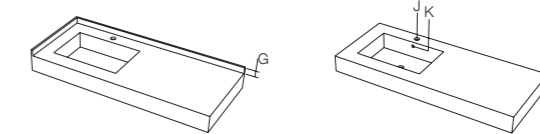

G = 5 - 10 cm J = Ø35 mm K = Ø30 mm

VÁLVULAS
VALVES / VANNES
SCARICO / ABLAUFVENTILE



PROPIEDADES / PROPERTIES / PROPRIÉTÉS / CARATTERISTICHE / EIGENSCHAFTEN

garantía 3 años *
3 years guarantee *
garantie 3 ans *
garanzia 3 anni *
3 Jahre Garantie *

fácil limpieza
easy cleaning
nettoyage facile
facile pulizia
leichte Reinigung

ligero
light weight
léger
leggero
leichtgewicht

masa pigmentada
pigmented mass
masse pigmentée
massa colorata
Pigmentmasse

hecho en España
made in Spain
fabriqué en Espagne
fatto in Spagna
in Spanien hergestellt

bacteriostático
bacteriostatic
bactériostatique
batteriostatico
bakterienhemmend

fácil instalación
easy installation
installation facile
facile installazione
einfache Installation

no absorbente
non-absorbent
non absorbant
non assorbente
nicht absorbierend

certificado
certificat
certifié
certificato
Zertifikat

* **extension de garantía opcional**
* optional warranty extension / * extension de garantie optionnelle
* estensione de garanzia opzionale / * optionale Garantieverlängerung

TEXTURAS / TEXTURES / TEXTURES / FINITURE / TEXTUREN



lisa
smooth
lisse
liscia
glatt



pizarra
slate
ardoise
ardesia
Schiefer

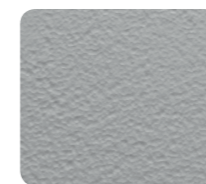

cemento
cement
ciment
cemento
Zement



madera
wood
bois
legno
Holz

COLORES Y ACABADOS / COLOURS AND FINISHES / COULEURS ET FINITIONS / COLORI E FINITURE / FARBEN UND AUSFÜHRUNGEN



RAL 9003



RAL 9001



NATURAL COLOUR SYSTEM



colores NCS
NCS colours
couleurs NCS
colori NCS
NCS Farben

colores RAL
RAL colours
couleurs RAL
colori RAL
RAL Farben



acabados TECH
TECH finishes
finitions TECH
finiture TECH
TECH Ausführungen



acabados DECO
DECO finishes
finitions DECO
finiture DECO
DECO Ausführungen



FABRICACIÓN A MEDIDA
CUSTOMIZED MANUFACTURE
FABRIQUE SUR MESURE
PRODUZIONE FATTA SU MISURA
FERTIGUNG NACH MAß

ENCIMERA
COUNTERTOP BASIN
PLAN VASQUE
PIANO LAVABO
WASCHTISCH

FIRENZE



OPCIONES / OPTIONS / OPTIONS / OPZIONI / OPTIONEN

MEDIDAS SENO / WASH BASIN MEASURES
MESURES DE LA CUVE / MISURE DI LAVABO
WASCHBECKEN GRÖSSE

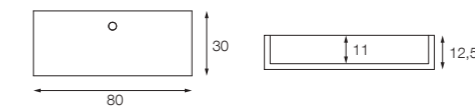

CORTE A MEDIDA / BESPOKE CUT
COUPE À MESURE / TAGLIO SU MISURA
SCHNITT NACH MAß

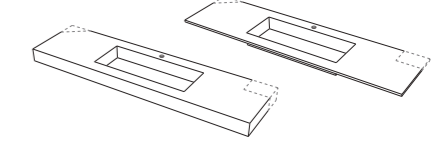

CON FALDONES O CONSOLA / WORKTOP WALL MOUNTED OR CONSOLE / AVEC TABLIER OU CONSOLE MURALE / PIANI LAVABO O CONSOLE / MIT WANDWASCHTISCH ODER KONSÖLE

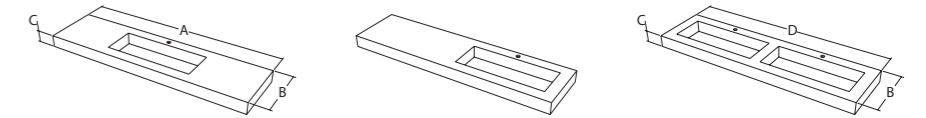

A = 100 - 221 cm B = 46 - 51 cm C = 12 - 15 cm D = 190 - 221 cm

SOBRE MUEBLE / COUNTERTOP BASIN / VASQUE SUR UN MEUBLE / LAVABI DA APPOGGIO / AUFSATZBECKEN AUF MÖBEL

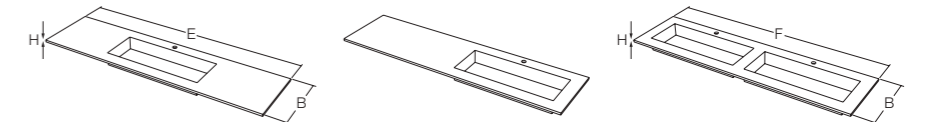

E = 94 - 221 cm B = 46 - 51 cm F = 184 - 221 cm H = 2 cm

TOALLERO FRONTAL O LATERAL / FRONTAL OR LATERAL TOWEL RAIL / PORTE-SERVIETTE FRONTAL OU LATÉRAL / PORTACIUGAMANI FRONTALE O LATERALE / VORDERER ODER SEITLICHER HANDTUCHHALTER

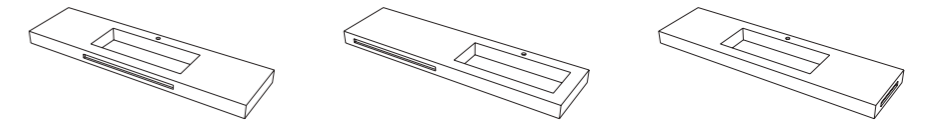

TOALLERO AQQ O ESTÁNDAR / AQQ OR STANDARD TOWEL RAIL / PORTE-SERVIETTE AQQ OU STANDARD / PORTACIUGAMANI AQQ O STANDARD / AQQ ODER STANDARD HANDTUCHHALTER

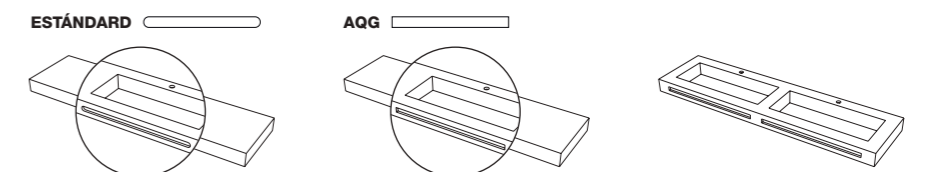

COPETE, REBOSADERO Y ORIFICIO PARA GRIFERÍA / TOPKNOT, OVERFLOW AND HOLE FOR FAUCETS / TOUPET, TROP-PLEIN ET TROU POUR ROBINETS / ALZATINE, TROPPO PIENO E FORO PER RUBINETTI / PROFIL, ÜBERLAUF UND ARMATURENLOCH

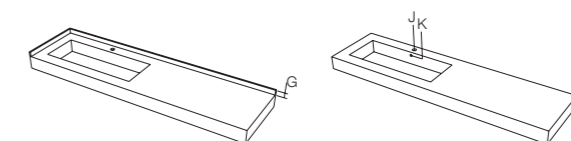

G = 5 - 10 cm J = Ø35 mm K = Ø30 mm

VÁLVULAS VALVES / VANNES
SCARICO / ABLAUFVENTILE



PROPIEDADES / PROPERTIES / PROPRIÉTÉS / CARATTERISTICHE / EIGENSCHAFTEN

garantía 3 años *
3 years guarantee *
garantie 3 ans *
garanzia 3 anni *
3 Jahre Garantie *

fácil limpieza
easy cleaning
nettoyage facile
facile pulizia
leichte Reinigung

ligero
light weight
léger
leggero
leichtgewichtig

masa pigmentada
pigmented mass
masse pigmentée
massa colorata
Pigmentmasse

hecho en España
made in Spain
fabriqué en Espagne
fatto in Spagna
in Spanien hergestellt

bacteriostático
bacteriostatic
bactériostatique
batteriostatico
bakterienhemmend

fácil instalación
easy installation
installation facile
facile installazione
einfache Installation

no absorbente
non-absorbent
non absorbant
non assorbente
nicht absorbierend

CE
certificado
certificat
certifié
certificato
Zertifikat

* extension de garantía opcional
* optional warranty extension / * extension de garantie optionnelle
* estensione de garanzia opzionale / * optionale Garantieverlängerung

TEXTURAS / TEXTURES / TEXTURES / FINITURE / TEXTUREN



lisa
smooth
lisse
liscia
glatt



pizarra
slate
ardoise
ardesia
Schiefer



cemento
cement
ciment
cemento
Zement



madera
wood
bois
legno
Holz

COLORES Y ACABADOS / COLOURS AND FINISHES / COULEURS ET FINITIONS / COLORI E FINITURE / FARBEN UND AUSFÜHRUNGEN



RAL 9003



RAL 9001



colores NCS
NCS colours
couleurs NCS
colori NCS
NCS Farben



colores RAL
RAL colours
couleurs RAL
colori RAL
RAL Farben



acabados TECH
TECH finishes
finitions TECH
finiture TECH
TECH Ausführungen



acabados DECO
DECO finishes
finitions DECO
finiture DECO
DECO Ausführungen



FABRICACIÓN A MEDIDA
CUSTOMIZED MANUFACTURE
FABRIQUE SUR MESURE
PRODUZIONE FATTA SU MISURA
FERTIGUNG NACH MAß

ENCIMERA
COUNTERTOP BASIN
PLAN VASQUE
PIANO LAVABO
WASCHTISCH

SICILIA



OPCIONES / OPTIONS / OPTIONS / OPZIONI / OPTIONEN

MEDIDAS SENO / WASH BASIN MEASURES
MESURES DE LA CUVE / MISURE DI LAVABO
WASCHBECKEN GRÖSSE

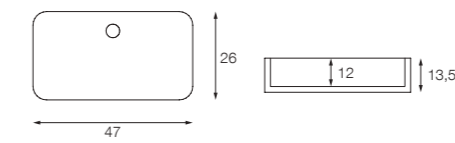

CORTE A MEDIDA / BESPOKE CUT
COUPE À MESURE / TAGLIO SU MISURA
SCHNITT NACH MAß

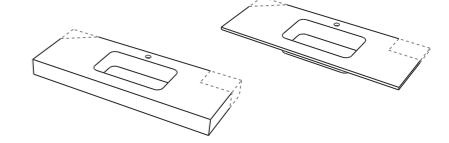

CON FALDONES O CONSOLA / WORKTOP WALL MOUNTED OR CONSOLE / AVEC TABLIER OU CONSOLE MURALE / PIANI LAVABO O CONSOLE / MIT WANDWASCHTISCH ODER KÖNSOLE

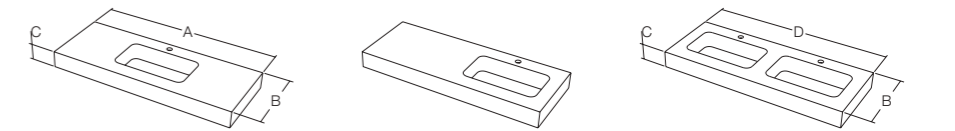

A = 66,5 - 221 cm B = 46 - 51 cm C = 12 - 15 cm D = 123 - 221 cm

SOBRE MUEBLE / COUNTERTOP BASIN / VASQUE SUR UN MEUBLE / LAVABI DA APPOGGIO / AUFSATZBECKEN AUF MÖBEL

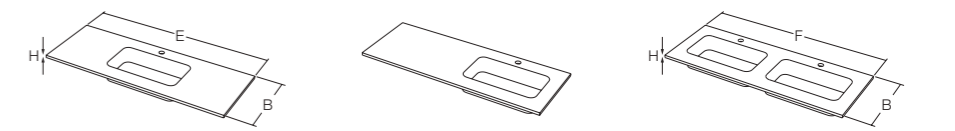

E = 60,5 - 221 cm B = 46 - 51 cm F = 117 - 221 cm H = 2 cm

TOALLERO FRONTAL O LATERAL / FRONTAL OR LATERAL TOWEL RAIL / PORTE-SERVIETTE FRONTAL OU LATÉRAL / PORTACIUGAMANI FRONTALE O LATERALE / VORDERER ODER SEITLICHER HANDTUCHHALTER

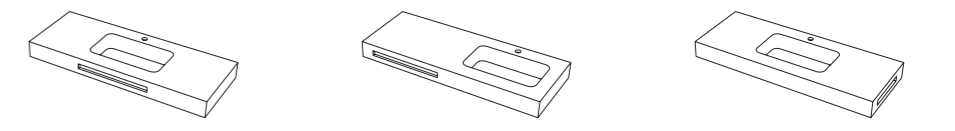

TOALLERO AQQ O ESTÁNDAR / AQQ OR STANDARD TOWEL RAIL / PORTE-SERVIETTE AQQ OU STANDARD / PORTACIUGAMANI AQQ O STANDARD / AQQ ODER STANDARD HANDTUCHHALTER

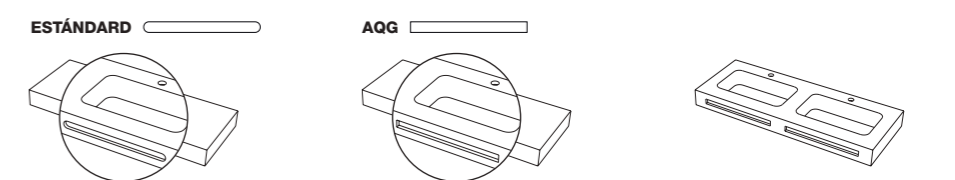

COPETE, REBOSADERO Y ORIFICIO PARA GRIFERÍA / TOPKNOT, OVERFLOW AND HOLE FOR FAUCETS / TOUPET, TROP-PLEIN ET TROU POUR ROBINETS / ALZATINE, TROPPO PIENO E FORO PER RUBINETTI / PROFIL, ÜBERLAUF UND ARMATURENLOCH

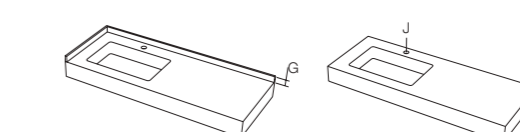

G = 5 - 10 cm J = Ø35 mm K = Ø30 mm

VÁLVULAS VALVES / VANNES
SCARICO / ABLAUFVENTILE



PROPIEDADES / PROPERTIES / PROPRIÉTÉS / CARATTERISTICHE / EIGENSCHAFTEN

garantía 3 años *
3 years guarantee *
garantie 3 ans *
garanzia 3 anni *
3 Jahre Garantie *

fácil limpieza
easy cleaning
nettoyage facile
facile pulizia
leichte Reinigung

ligero
light weight
léger
leggero
leichtgewicht

masa pigmentada
pigmented mass
masse pigmentée
massa colorata
Pigmentmasse

hecho en España
made in Spain
fabriqué en Espagne
fatto in Spagna
in Spanien hergestellt

bacteriostático
bacteriostatic
bactériostatique
batteriostatico
bakterienhemmend

fácil instalación
easy installation
installation facile
facile installazione
einfache Installation

no absorbente
non-absorbent
non absorbant
non assorbente
nicht absorbierend

CE
certificado
certicate
certifié
certificato
Zertifikat

* extension de garantía opcional
* optional warranty extension / * extension de garantie optionnelle
* estensione de garanzia opzionale / * optionale Garantieverlängerung

TEXTURAS / TEXTURES / TEXTURES / FINITURE / TEXTUREN



lisa
smooth
lisse
liscia
glatt



pizarra
slate
ardoise
ardesia
Schiefer

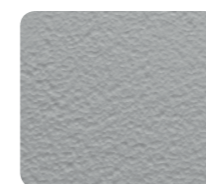

cemento
cement
ciment
cemento
Zement



madera
wood
bois
legno
Holz

COLORES Y ACABADOS / COLOURS AND FINISHES / COULEURS ET FINITIONS / COLORI E FINITURE / FARBEN UND AUSFÜHRUNGEN



RAL 9003



RAL 9001



NATURAL COLOUR SYSTEM



RAL 7035



RAL 7044

colores NCS
NCS colours
couleurs NCS
colori NCS
NCS Farben

colores RAL
RAL colours
couleurs RAL
colori RAL
RAL Farben

acabados TECH
TECH finishes
finitions TECH
finiture TECH
TECH Ausführungen

acabados DECO
DECO finishes
finitions DECO
finiture DECO
DECO Ausführungen



FABRICACIÓN A MEDIDA
CUSTOMIZED MANUFACTURE
FABRIQUE SUR MESURE
PRODUZIONE FATTA SU MISURA
FERTIGUNG NACH MAß

ENCIMERA
COUNTERTOP BASIN
PLAN VASQUE
PIANO LAVABO
WASCHTISCH

NAPOLI



OPCIONES / OPTIONS / OPTIONS / OPZIONI / OPTIONEN

MEDIDAS SENO / WASH BASIN MEASURES
MESURES DE LA CUVE / MISURE DI LAVABO
WASCHBECKEN GRÖSSE

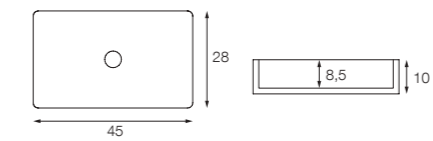

CORTE A MEDIDA / BESPOKE CUT
COUPE À MESURE / TAGLIO SU MISURA
SCHNITT NACH MAß

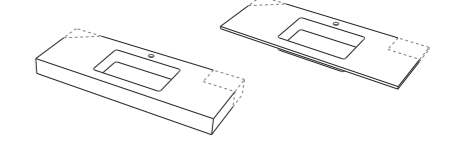

CON FALDONES O CONSOLA / WORKTOP WALL MOUNTED OR CONSOLE / AVEC TABLIER OU CONSOLE MURALE / PIANI LAVABO O CONSOLE / MIT WANDWASCHTISCH ODER KONSOLE

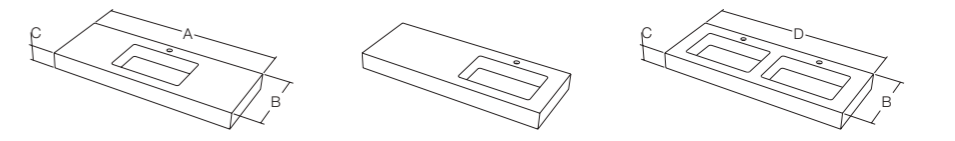

A = 66 - 221 cm B = 46 - 51 cm C = 12 - 15 cm D = 122 - 221 cm

SOBRE MUEBLE / COUNTERTOP BASIN / VASQUE SUR UN MEUBLE / LAVABI DA APPOGGIO / AUFSATZBECKEN AUF MÖBEL

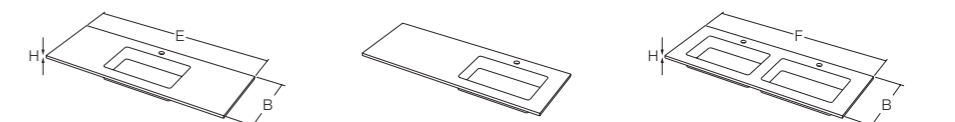

E = 60 - 221 cm B = 46 - 51 cm F = 116 - 221 cm H = 2 cm

TOALLERO FRONTAL O LATERAL / FRONTAL OR LATERAL TOWEL RAIL / PORTE-SERVIETTE FRONTAL OU LATÉRAL / PORTACIUGAMANI FRONTALE O LATERALE / VORDERER ODER SEITLICHER HANDTUCHHALTER

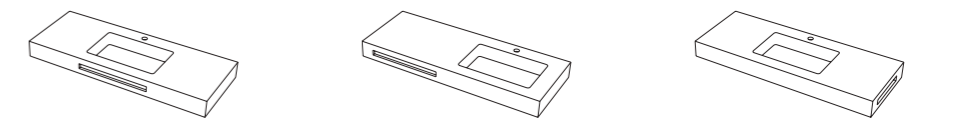

TOALLERO AQQ O ESTÁNDAR / AQQ OR STANDARD TOWEL RAIL / PORTE-SERVIETTE AQQ OU STANDARD / PORTACIUGAMANI AQQ O STANDARD / AQQ ODER STANDARD HANDTUCHHALTER

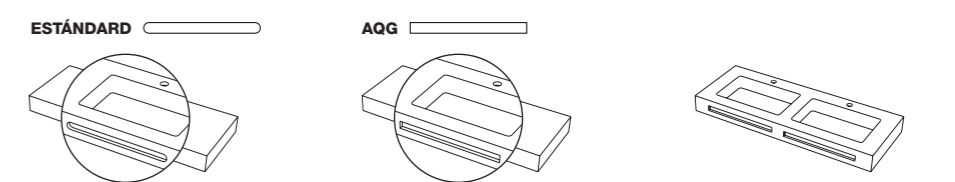

COPETE Y ORIFICIO PARA GRIFERÍA / TOPKNOT AND HOLE FOR FAUCETS / TOUPET ET TROU POUR ROBINETS / ALZATINE E FORO PER RUBINETTI / PROFIL UND ARMATURENLOCH

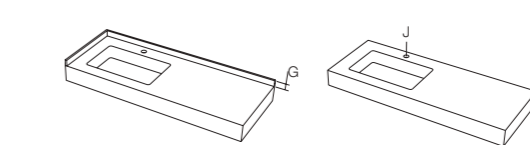

G = 5 - 10 cm J = Ø35 mm

VÁLVULAS VALVES / VANNES
SCARICO / ABLAUFVENTILE



PROPIEDADES / PROPERTIES / PROPRIÉTÉS / CARATTERISTICHE / EIGENSCHAFTEN



garantía 3 años *
3 years guarantee *
garantie 3 ans *
garanzia 3 anni *
3 Jahre Garantie *



fácil limpieza
easy cleaning
nettoyage facile
facile pulizia
leichte Reinigung



ligero
light weight
léger
leggero
leichtgewichtig



masa pigmentada
pigmented mass
masse pigmentée
massa colorata
Pigmentmasse

TEXTURAS / TEXTURES / TEXTURES / FINITURE / TEXTUREN



lisa
smooth
lisse
liscia
glatt



pizarra
slate
ardoise
ardesia
Schiefer

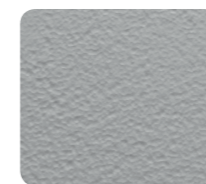

cemento
cement
ciment
cemento
Zement



madera
wood
bois
legno
Holz



hecho en España
made in Spain
fabriqué en Espagne
fatto in Spagna
in Spanien hergestellt



bacteriostático
bacteriostatic
bactériostatique
batteriostatico
bakterienhemmend



fácil instalación
easy installation
installation facile
facile installazione
einfache Installation



no absorbente
non-absorbent
non absorbant
non assorbente
nicht absorbierend

COLORES Y ACABADOS / COLOURS AND FINISHES / COULEURS ET FINITIONS / COLORI E FINITURE / FARBEN UND AUSFÜHRUNGEN



RAL 9003



RAL 9001



NCS
NATURAL COLOUR SYSTEM



RAL



TECH



DECO



RAL 7035



RAL 7044

colores NCS
NCS colours
couleurs NCS
colori NCS
NCS Farben

colores RAL
RAL colours
couleurs RAL
colori RAL
RAL Farben

acabados TECH
TECH finishes
finitions TECH
finiture TECH
TECH Ausführungen

acabados DECO
DECO finishes
finitions DECO
finiture DECO
DECO Ausführungen



certificado
certicate
certifié
certificato
Zertifikat

* **extension de garantía opcional**
* optional warranty extension / * extension de garantie optionnelle
* estensione de garanzia opzionale / * optionale Garantieverlängerung

SOLUTION

ENCIMERA
COUNTERTOP BASIN
PLAN VASQUE
PIANO LAVABO
WASCHTISCH

FABRICACIÓN A MEDIDA PARA COLECTIVIDADES
CUSTOMIZED MANUFACTURE FOR COLLECTIVITIES
FABRIQUÉ SUR MESURE POUR COLLECTIVITÉS
PRODUZIONE FATTA SU MISURA PER LE COLLETTIVITÀ
FERTIGUNG NACH MAß FÜR KOLLEKTIVITÄTEN





OPCIONES / OPTIONS / OPTIONS / OPZIONI / OPTIONEN

MEDIDAS SENO / WASH BASIN MEASURES
MESURES DE LA CUVE / MISURE DI LAVABO
WASCHBECKEN GRÖSSE

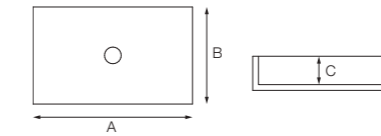

Medidas ajustables
A B C = Adjustable measurements / Mesures ajustables
Misure regolabili / Anpassbare Größen

CORTE A MEDIDA / BESPOKE CUT
COUPE À MESURE / TAGLIO SU MISURA
SCHNITT NACH MAß

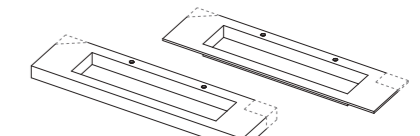

CON FALDONES O CONSOLA / WORKTOP WALL MOUNTED OR CONSOLE / AVEC TABLIER OU CONSOLE MURALE / PIANI LAVABO O CONSOLE / MIT WANDWASCHTISCH ODER KONSOLE

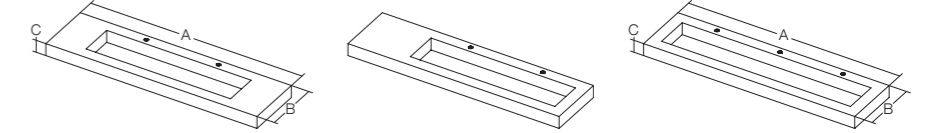

A B C = Medidas ajustables / Adjustable measurements / Mesures ajustables / Misure regolabili / Anpassbare Größen

SOBRE MUEBLE / COUNTERTOP BASIN / VASQUE SUR UN MEUBLE / LAVABI DA APPOGGIO / AUFSATZBECKEN AUF MÖBEL

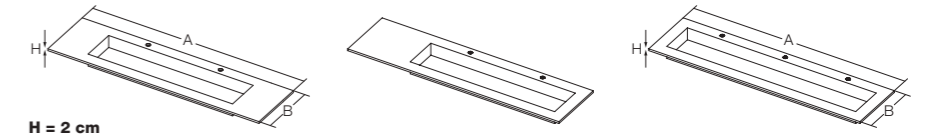

H = 2 cm
A B = Medidas ajustables / Adjustable measurements / Mesures ajustables / Misure regolabili / Anpassbare Größen

TOALLERO FRONTAL O LATERAL / FRONTAL OR LATERAL TOWEL RAIL / PORTE-SERVIETTE FRONTAL OU LATÉRAL / PORTACIUGAMANI FRONTALE O LATERALE / VORDERER ODER SEITLICHER HANDTUCHHALTER

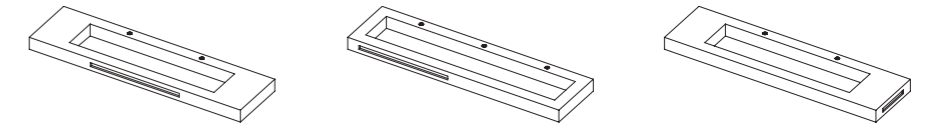

TOALLERO AQQ O ESTÁNDAR / AQQ OR STANDARD TOWEL RAIL / PORTE-SERVIETTE AQQ OU STANDARD / PORTACIUGAMANI AQQ O STANDARD / AQQ ODER STANDARD HANDTUCHHALTER

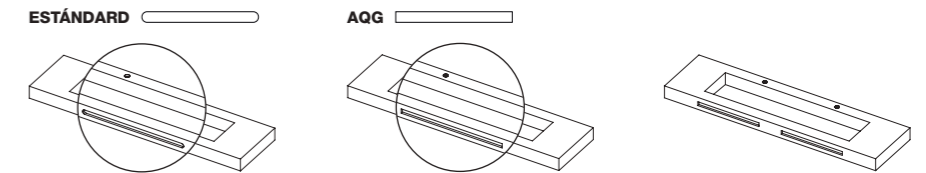

REBOSADERO Y ORIFICIO PARA GRIFERÍA / OVERFLOW AND HOLE FOR FAUCETS / TROP-PLEIN ET TROU POUR ROBINETS / TROPPO PIENO E FORO PER RUBINETTI / ÜBERLAUF UND ARMATURENLOCH

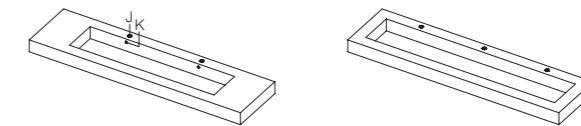

J = Ø35 mm K = Ø30 mm

VÁLVULAS VALVES / VANNES SCARICO / ABLAUFVENTILE



PROPIEDADES / PROPERTIES / PROPRIÉTÉS / CARATTERISTICHE / EIGENSCHAFTEN



garantía 3 años *
3 years guarantee *
garantie 3 ans *
garanzia 3 anni *
3 Jahre Garantie *



fácil limpieza
easy cleaning
nettoyage facile
facile pulizia
leichte Reinigung



ligero
light weight
léger
leggero
leichtgewichtig



masa pigmentada
pigmented mass
masse pigmentée
massa colorata
Pigmentmasse



hecho en España
made in Spain
fabriqué en Espagne
fatto in Spagna
in Spanien hergestellt



bacteriostático
bacteriostatic
bactériostatique
batteriostatico
bakterienhemmend



fácil instalación
easy installation
installation facile
facile installazione
einfache Installation



no absorbente
non-absorbent
non absorbant
non assorbente
nicht absorbierend



certificado
certicate
certifié
certificato
Zertifikat

* extension de garantía opcional
* optional warranty extension / * extension de garantie optionnelle
* estensione de garanzia opzionale / * optionale Garantieverlängerung

TEXTURAS / TEXTURES / TEXTURES / FINITURE / TEXTUREN



lisa
smooth
lisse
liscia
glatt



pizarra
slate
ardoise
ardesia
Schiefer



cemento
cement
ciment
cemento
Zement



madera
wood
bois
legno
Holz

COLORES Y ACABADOS / COLOURS AND FINISHES / COULEURS ET FINITIONS / COLORI E FINITURE / FARBEN UND AUSFÜHRUNGEN



RAL 9003



RAL 9001



NATURAL COLOUR SYSTEM



RAL 7035



RAL 7044

colores NCS
NCS colours
couleurs NCS
colori NCS
NCS Farben

colores RAL
RAL colours
couleurs RAL
colori RAL
RAL Farben

acabados TECH
TECH finishes
finitions TECH
finiture TECH
TECH Ausführungen

acabados DECO
DECO finishes
finitions DECO
finiture DECO
DECO Ausführungen



1 BERGAMO

ENCIMERA
COUNTERTOP BASIN
PLAN VASQUE
PIANO LAVABO
WASCHTISCH

TECH: SUNRISE WOOD

p. 76

2 VERONA

CONSOLA
CONSOLE
CONSOLE MURALE
CONSOLE
KONSOLE

TECH: WHITE MARBLE

p. 54



1 BERGAMO

ENCIMERA
COUNTERTOP BASIN
PLAN VASQUE
PIANO LAVABO
WASCHTISCH

TECH: GREY STONE

p. 76

2 CANNES

LAVABO
WASHBASIN
VASQUE
LAVABO
WASCHBECKEN

RAL: 9005

p. 116



ENCIMERA PARA LAVABOS / COUNTERTOP FOR WASHBASIN
PLAN POUR VASQUES / PIANO PER LAVABI / KONSOLENPLATTE FÜR WASCHECKEN

OPCIONES / OPTIONS / OPTIONS / OPZIONI / OPTIONEN

MEDIDAS / MEASURES / MESURES / MISUR / ABMESSUNGEN

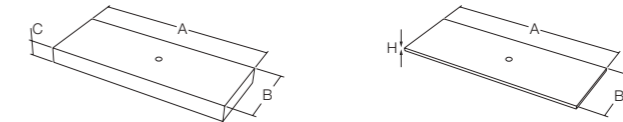

A = max. 221 cm B = 46 - 51 cm C = 12 - 15 cm H = 2 cm

CORTE A MEDIDA / BESPOKE CUT / COUPE À MESURE / TAGLIO SU MISURA SCHNITT NACH MAß



TOALLERO FRONTAL O LATERAL / FRONTAL OR LATERAL TOWEL RAIL / PORTE-SERVIETTE
FRONTAL OU LATÉRAL / PORTACIUGAMANI FRONTALE O LATERALE / VORDERER ODER SEITLICHER
HANDTUCHHALTER

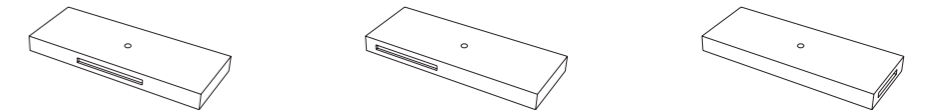

TOALLERO AQQ O ESTÁNDAR / AQQ OR STANDARD TOWEL RAIL / PORTE-SERVIETTE AQQ OU
STANDARD / PORTACIUGAMANI AQQ O STANDARD / AQQ ODER STANDARD HANDTUCHHALTER

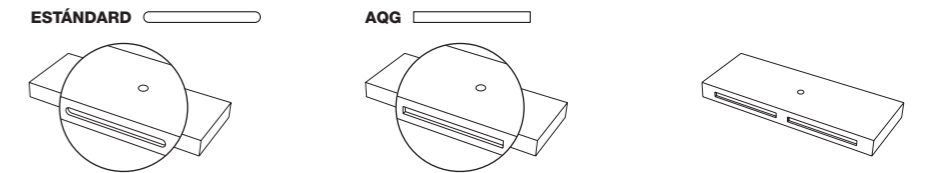

COPETE, REBOSADERO Y ORIFICIO PARA GRIFERÍA / TOPKNOT, OVERFLOW AND HOLE FOR FAUCETS / TOUPET, TROP-PLEIN ET
TROU POUR ROBINETS / ALZATINE, TROPPO PIENO E FORO PER RUBINETTI / PROFIL, ÜBERLAUF UND ARMATURENLOCH

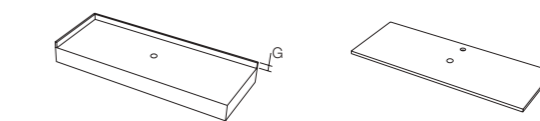









G = 5 - 10 cm

VÁLVULAS VALVES / VANNES
SCARICO / ABLAUFVENTILE



PROPIEDADES / PROPERTIES / PROPRIÉTÉS / CARATTERISTICHE / EIGENSCHAFTEN



 garantía 3 años * 3 years guarantee * garantie 3 ans * garanzia 3 anni * 3 Jahre Garantie *	 fácil limpieza easy cleaning nettoyage facile facile pulizia leichte Reinigung	 ligero light weight léger leggero leichtgewichtig	 masa pigmentada pigmented mass masse pigmentée massa colorata Pigmentmasse
----------------------------------------------------------------------------------------------------------------------------------------------------------------------------------------------------	---------------------------------------------------------------------------------------------------------------------------------------------------------------------------------------	----------------------------------------------------------------------------------------------------------------------------------------------------------	-------------------------------------------------------------------------------------------------------------------------------------------------------------------------------------

 hecho en España made in Spain fabriqué en Espagne fatto in Spagna in Spanien hergestellt	 bacteriostático bacteriostatic bactériostatique batteriostatico bakterienhemmend	 fácil instalación easy installation installation facile facile installazione einfache Installation	 no absorbente non-absorbent non absorbant non assorbente nicht absorbierend
-------------------------------------------------------------------------------------------------------------------------------------------------------------------------------------------------	-----------------------------------------------------------------------------------------------------------------------------------------------------------------------------------------	-----------------------------------------------------------------------------------------------------------------------------------------------------------------------------------------------------------	--------------------------------------------------------------------------------------------------------------------------------------------------------------------------------------









 **certificado**
certificat
certifié
certificato
Zertifikat

* **extension de garantía opcional**
* optional warranty extension / * extension de garantie optionnelle
* estensione de garanzia opzionale / * optionale Garantieverlängerung

TEXTURAS / TEXTURES / TEXTURES / FINITURE / TEXTUREN

 lisa smooth lisse liscia glatt	 pizarra slate ardoise ardesia Schiefer	 cemento cement ciment cemento Zement	 madera wood bois legno Holz
-----------------------------------------------------------------------------------------------------------------------------------------	-------------------------------------------------------------------------------------------------------------------------------------------------	-----------------------------------------------------------------------------------------------------------------------------------------------	--------------------------------------------------------------------------------------------------------------------------------------

COLORES Y ACABADOS / COLOURS AND FINISHES / COULEURS ET FINITIONS / COLORI E FINITURE / FARBEN UND AUSFÜHRUNGEN

 RAL 9003	 RAL 9001	 NCS NATURAL COLOUR SYSTEM	 RAL	 acabados TECH TECH finishes finitions TECH finiture TECH TECH Ausführungen	 acabados DECO DECO finishes finitions DECO finiture DECO DECO Ausführungen
 RAL 7035	 RAL 7044	colores NCS NCS colours couleurs NCS colori NCS NCS Farben	colores RAL RAL colours couleurs RAL colori RAL RAL Farben		



ESTANTES Y BALDAS
RACKS AND SHELVES
ÉTAGÈRES ET TABLETTES
SCAFFALI E RIPIANI
REGALE UND ABLAGEN

ESTANTES Y BALDAS
RACKS AND SHELVES
ÉTAGÈRES ET TABLETTES
SCAFFALI E RIPIANI
REGALE UND ABLAGEN

FABRICACIÓN A MEDIDA
CUSTOMIZED MANUFACTURE
FABRIQUE SUR MESURE
PRODUZIONE FATTA SU MISURA
FERTIGUNG NACH MAß

BALDAS



① ESTANTE

ESTANTE
RACK
ÉTAGÈRE
SCAFFALO
REGAL

TECH COLOUR: PROVENZAL WOOD

p. 84

② VERONA

ENCIMERA
COUNTERTOP BASIN
PLAN VASQUE
PIANO LAVABO
WASCHTISCH

RAL: 9003

p. 54

③ BERGAMO

ENCIMERA
COUNTERTOP BASIN
PLAN VASQUE
PIANO LAVABO
WASCHTISCH

TECH COLOUR: PROVENZAL WOOD

p. 76

④ BALDA

BALDA
SHELF
TABLETTE
RIPIANO
ABLAGE

TECH COLOUR: PROVENZAL WOOD

p. 84



OPCIONES / OPTIONS / OPTIONS / OPZIONI / OPTIONEN

MEDIDAS / MEASURES / MESURES / MISUR / ABMESSUNGEN

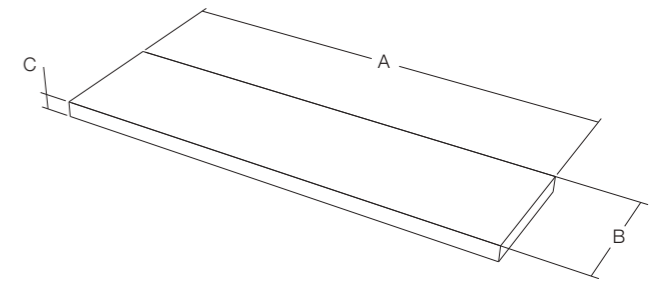

A = max. 221 cm B = 26 - 51 cm C = 2 - 6 cm

CORTE A MEDIDA / BESPOKE CUT / COUPE À MESURE / TAGLIO SU MISURA / SCHNITT NACH MAß

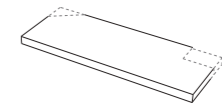

COPETE / TOPKNOT / TOUPET / ALZATINE / PROFIL

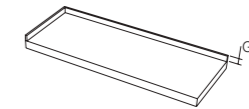

G = 5 - 10 cm

TEXTURAS / TEXTURES / TEXTURES / FINITURE / TEXTUREN



lisa
smooth
lisse
liscia
glatt



pizarra
slate
ardoise
ardesia
Schiefer



cemento
cement
ciment
cemento
Zement



madera
wood
bois
legno
Holz

PROPIEDADES / PROPERTIES / PROPRIÉTÉS / CARATTERISTICHE / EIGENSCHAFTEN



garantía 3 años *
3 years guarantee *
garanzia 3 anni *
3 Jahre Garantie *



fácil limpieza
easy cleaning
nettoyage facile
facile pulizia
leichte Reinigung



ligero
light weight
léger
leggero
leichtgewichtig



masa pigmentada
pigmented mass
masse pigmentée
massa colorata
Pigmentmasse



hecho en España
made in Spain
fabriqué en Espagne
fatto in Spagna
in Spanien hergestellt



bacteriostático
bacteriostatic
bactériostatique
batteriosstatico
bakterienhemmend



fácil instalación
easy installation
installation facile
facile installazione
einfache Installation



no absorbente
non-absorbent
non absorbant
non assorbente
nicht absorbierend



certificado
certificate
certifié
certificato
Zertifikat

* **extension de garantía opcional**
* optional warranty extension / * extension de garantie optionnelle
* estensione de garanzia opzionale / * optionale Garantieverlängerung

COLORES Y ACABADOS / COLOURS AND FINISHES / COULEURS ET FINITIONS / COLORI E FINITURE / FARBEN UND AUSFÜHRUNGEN



RAL 9003



RAL 9001



NATURAL COLOUR SYSTEM



RAL



TECH



DECO



RAL 7035



RAL 7044

colores NCS
NCS colours
couleurs NCS
colori NCS
NCS Farben

colores RAL
RAL colours
couleurs RAL
colori RAL
RAL Farben

acabados TECH
TECH finishes
finitions TECH
finiture TECH
TECH Ausführungen

acabados DECO
DECO finishes
finitions DECO
finiture DECO
DECO Ausführungen



MUEBLE PARA ENCIMERA
METALLIC STRUCTURE
MEUBLE SOUS VASQUE
MOBILE PER PIANO LAVABO
MÖBELSTRUKTUR FÜR WASCHPLATTEN



1 **EXOS P**
MUEBLE PARA ENCIMERA
METALLIC STRUCTURE
MEUBLE SOUS VASQUE
MOBILE PER PIANO LAVABO
MÖBELSTRUKTUR FÜR WASCHPLATTEN
COLOR: NEGRO / BLACK

p. 90

2 **BERGAMO**
ENCIMERA
COUNTERTOP BASIN
PLAN VASQUE
PIANO LAVABO
WASCHTISCH
RAL: 9005

p. 76

3 **NIMES R**
LAVABO
WASHBASIN
VASQUE
LAVABO
WASCHBECKEN
RAL: 9005

p. 106

②

③

①

①

NIMES R

LAVABO
WASHBASIN
VASQUE
LAVABO
WASCHBECKEN

RAL: 9003

p. 106

②

BERGAMO

ENCIMERA
COUNTERTOP BASIN
PLAN VASQUE
PIANO LAVABO
WASCHTISCH

RAL: 9003

p. 76

③

EXOS S

MUEBLE PARA ENCIMERA
METALLIC STRUCTURE
MEUBLE SOUS VASQUE
MOBILE PER PIANO LAVABO
MÖBELSTRUKTUR FÜR WASCHPLATTEN

COLOR: NEGRO / BLACK

p. 90

FABRICACIÓN A MEDIDA
CUSTOMIZED MANUFACTURE
FABRIQUE SUR MESURE
PRODUZIONE FATTA SU MISURA
FERTIGUNG NACH MAß

MUEBLE PARA ENCIMERA
METALLIC STRUCTURE
MEUBLE SOUS VASQUE
MOBILE PER PIANO LAVABO
MÖBELSTRUKTUR FÜR WASCHPLATTEN

EXOS



EXOS S

MEDIDAS / MEASURES / MESURES / MISUR / ABMESSUNGEN

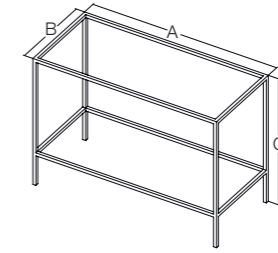

A = 81 - 141 cm B = 46 cm C = 85 cm

OPCIONES / OPTIONS / OPTIONS / OPZIONI / OPTIONEN

CON O SIN BALDA (METÁLICA O DE RESINA) / WITH OR WITHOUT SHELF (METALLIC OR RESIN) AVEC OU SANS TABLETTE (MÉTALLIQUE OU EN RÉSINE) / CON O SENZA RIPIANO (METALLICO O RESINA) MIT ODER OHNE REGAL (METALL ODER HARZ)

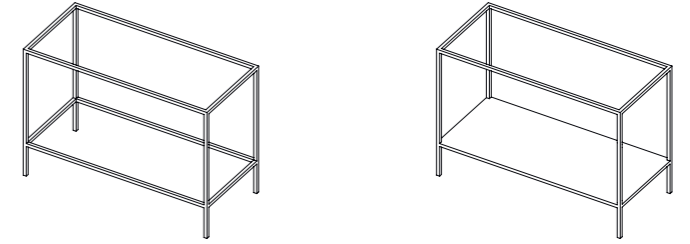

PATAS LINEAR O SQUARE / LINEAR OR SQUARE LEGS / PATTES LINEAR OU SQUARE
GAMBE LINEAR O SQUARE / LINEAR ODER SQUARE BEINE

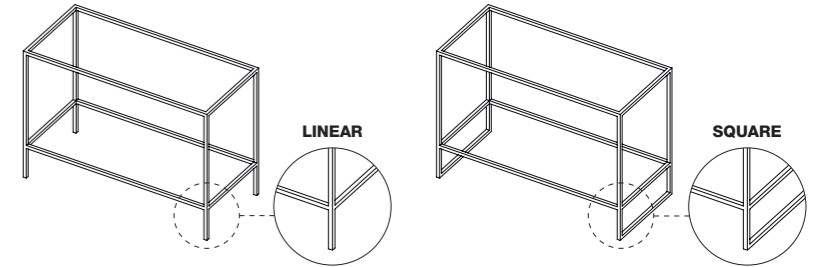

EXOS P

MEDIDAS / MEASURES / MESURES / MISUR / ABMESSUNGEN

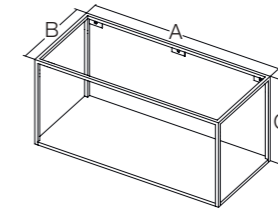

A = 81 - 141 cm B = 46 cm C = 55 cm

OPCIONES / OPTIONS / OPTIONS / OPZIONI / OPTIONEN

PROPIEDADES
PROPERTIES / PROPRIÉTÉS / CARATTERISTICHE / EIGENSCHAFTEN



garantía 3 años *
3 years guarantee *
garantie 3 ans *
garanzia 3 anni *
3 Jahre Garantie *



fácil limpieza
easy cleaning
nettoyage facile
facile pulizia
leichte Reinigung



hecho en España
made in Spain
fabriqué en Espagne
fatto in Spagna
in Spanien hergestellt



ligero
light weight
léger
leggero
leichtgewichtig



fácil instalación
easy installation
installation facile
facile installazione
einfache Installation



grosor
thickness
épaisseur
spessore
Dicke

COLORES
COLOURS / COULEURS / COLORI / FARBEN



blanco
white
blanc
bianco
Weiß



negro
black
noir
nero
Schwarz



niquelado
nickel plated
plaqué nickel
placcato nickel
vernickelt

BALDA METÁLICA O DE RESINA / METALLIC OR RESIN SHELF / TABLETTE MÉTALLIQUE OU EN RÉSINE / RIPIANO METALLICO O RESINA / METALLREGAL
ODER HARZREGAL

TOALLERO FRONTAL - LATERAL / FRONTAL - LATERAL TOWEL RAIL / PORTE-SERVIETTE FRONTAL - LATÉRAL / PORTASCIUGAMANI FRONTALE -
LATERALE / VORDERER - SEITLICHER HANDTUCHHALTER

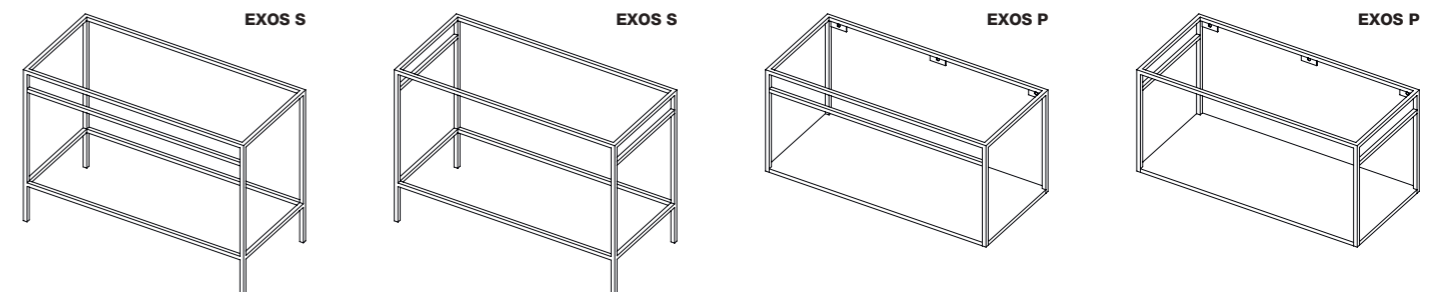



LAVABOS
WASHBASINS
VASQUES
LAVABI
WASCHBECKEN

ESTILIZA TU LAVABO
ENHANCE YOUR WASHBASIN
STYLISEZ VOTRE VASQUE
STILIZZA IL TUO LAVABO
GESTALTEN SIE IHR WASCHBECKEN

LAVABO
WASHBASIN
VASQUE
LAVABO
WASCHBECKEN

ARTEBA



① ARTEBA

LAVABO
WASHBASIN
VASQUE
LAVABO
WASCHBECKEN

RAL: 9003

p. 98

② BERGAMO

ENCIMERA
COUNTERTOP BASIN
PLAN VASQUE
PIANO LAVABO
WASCHTISCH

TECH: SUNRISE WOOD

p. 76

③ EXOS S

MUEBLE PARA ENCIMERA
METALLIC STRUCTURE
MEUBLE SOUS VASQUE
MOBILE PER PIANO LAVABO
MÖBELSTRUKTUR FÜR WASCHPLATTEN

COLOR: NEGRO / BLACK

p. 90

④ SOFTUM

PLATO DE DUCHA
SHOWER TRAY
RECEVEUR DE DOUCHE
PIATTO DOCCIA
DUSCHWANNE

RAL: 9003

p. 126

⑤ PANEL

PANEL DE REVESTIMIENTO
WALL PANEL
PANNEAU MURAL
PANNELLO DI REVESTIMENTO
VERKLEIDUNGSPLATTE

TECH: DARK CEMENT

p. 164

ESTILIZA TU LAVABO
 ENHANCE YOUR WASHBASIN
 STYLISEZ VOTRE VASQUE
 STILIZZA IL TUO LAVABO
 GESTALTEN SIE IHR WASCHBECKEN

LAVABO
 WASHBASIN
 VASQUE
 LAVABO
 WASCHBECKEN

ARTEBA



ARTEBA



MEDIDAS / MEASURES / MESURES
 MISUR / ABMESSUNGEN

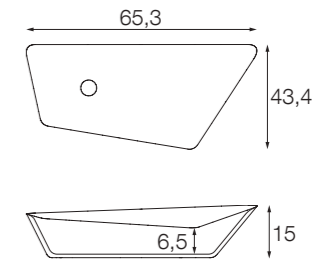

OPCIONES / OPTIONS /
 OPTIONS / OPZIONI / OPTIONEN

TEXTURA / TEXTURE / TEXTURE
 FINITURA / TEXTUR



lisa
 smooth
 lisse
 liscia
 glatt

VÁLVULAS / VALVES / VANNES
 SCARICO / ABLAUFVENTILE



PROPIEDADES / PROPERTIES / PROPRIÉTÉS / CARATTERISTICHE / EIGENSCHAFTEN



garantía 3 años *
 3 years guarantee *
 garantie 3 ans *
 garanzia 3 anni *
 3 Jahre Garantie *



fácil limpieza
 easy cleaning
 nettoyage facile
 facile pulizia
 leichte Reinigung



masa pigmentada
 pigmented mass
 masse pigmentée
 massa colorata
 Pigmentmasse



fácil instalación
 easy installation
 installation facile
 facile installazione
 einfache Installation



hecho en España
 made in Spain
 fabriqué en Espagne
 fatto in Spagna
 in Spanien hergestellt



bacteriostático
 bacteriostatic
 bactériostatique
 batteriostatico
 bakterienhemmend



no absorbente
 non-absorbent
 non absorbant
 non assorbente
 nicht absorbierend



certificado
 certificate
 certifié
 certificato
 Zertifikat

* **extensión de garantía opcional** / * **optional warranty extension** / * **extension de garantie optionnelle** / * **estensione de garanzia opzionale** / * **optionale Garantieverlängerung**

COLORES Y ACABADOS / COLOURS AND FINISHES / COULEURS ET FINITIONS / COLORI E FINITURE / FARBEN UND AUSFÜHRUNGEN



RAL 9003



RAL 9001



RAL 7044



RAL 7037

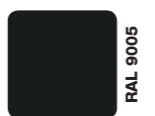

RAL 9005



RAL 7035



RAL 1013



RAL 1019



RAL 7015



RAL 8017



colores NCS
 NCS colours
 couleurs NCS
 colori NCS
 NCS Farben



colores RAL
 RAL colours
 couleurs RAL
 colori RAL
 RAL Farben



acabados DECO
 DECO finishes
 finitions DECO
 finiture DECO
 DECO Ausführungen

ESTILIZA TU LAVABO
ENHANCE YOUR WASHBASIN
STYLISEZ VOTRE VASQUE
STILIZZA IL TUO LAVABO
GESTALTEN SIE IHR WASCHBECKEN

LAVABO
WASHBASIN
VASQUE
LAVABO
WASCHBECKEN

NIMES E

4 SOFTUM

PLATO DE DUCHA
SHOWER TRAY
RECEVEUR DE DOUCHE
PIATTO DOCCIA
DUSCHWANNE

RAL: 9003

p. 126

4

1 NIMES E

LAVABO
WASHBASIN
VASQUE
LAVABO
WASCHBECKEN

RAL: 9003

p. 102

2 BERGAMO

ENCIMERA
COUNTERTOP BASIN
PLAN VASQUE
PIANO LAVABO
WASCHTISCH

DECO: TERRAZZO NEGRO

p. 76

3 EXOS S

MUEBLE PARA ENCIMERA
METALLIC STRUCTURE
MEUBLE SOUS VASQUE
MOBILE PER PIANO LAVABO
MÖBELSTRUKTUR FÜR WASCHPLATTEN

COLOR: NEGRO / BLACK

p. 90

ESTILIZA TU LAVABO
ENHANCE YOUR WASHBASIN
STYLISEZ VOTRE VASQUE
STILIZZA IL TUO LAVABO
GESTALTEN SIE IHR WASCHBECKEN

LAVABO
WASHBASIN
VASQUE
LAVABO
WASCHBECKEN

NIMES E



NIMES E



MEDIDAS / MEASURES / MESURES
MISUR / ABMESSUNGEN

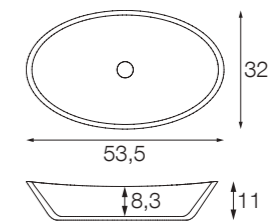

OPCIONES / OPTIONS /
OPTIONS / OPZIONI / OPTIONEN

TEXTURA / TEXTURE / TEXTURE
FINITURA / TEXTUR



lisa
smooth
lisse
liscia
glatt

VÁLVULAS / VALVES / VANNES
SCARICO / ABLAUFVENTILE



PROPIEDADES / PROPERTIES / PROPRIÉTÉS / CARATTERISTICHE / EIGENSCHAFTEN



garantía 3 años *
3 years guarantee *
garantie 3 ans *
garanzia 3 anni *
3 Jahre Garantie *



fácil limpieza
easy cleaning
nettoyage facile
facile pulizia
leichte Reinigung



masa pigmentada
pigmented mass
masse pigmentée
massa colorata
Pigmentmasse



fácil instalación
easy installation
installation facile
facile installazione
einfache Installation



hecho en España
made in Spain
fabriqué en Espagne
fatto in Spagna
in Spanien hergestellt



bacteriostático
bacteriostatic
bactériostatique
batteriostatico
bakterienhemmend



no absorbente
non-absorbent
non absorbant
non assorbente
nicht absorbierend



certificado
certificate
certifié
certificato
Zertifikat

COLORES Y ACABADOS / COLOURS AND FINISHES / COULEURS ET FINITIONS / COLORI E FINITURE / FARBEN UND AUSFÜHRUNGEN



RAL 9003



RAL 9001



RAL 7044



RAL 7037



RAL 9005



RAL 7035



RAL 1013



RAL 1019



RAL 7015



RAL 8017



colores NCS
NCS colours
couleurs NCS
colori NCS
NCS Farben



colores RAL
RAL colours
couleurs RAL
colori RAL
RAL Farben



acabados DECO
DECO finishes
finitions DECO
finiture DECO
DECO Ausführungen

* extensión de garantía opcional / * optional warranty extension / * extension de garantie optionnelle / * estensione de garanzia opzionale / * optionale Garantieverlängerung

ESTILIZA TU LAVABO
ENHANCE YOUR WASHBASIN
STYLISEZ VOTRE VASQUE
STILIZZA IL TUO LAVABO
GESTALTEN SIE IHR WASCHBECKEN

LAVABO
WASHBASIN
VASQUE
LAVABO
WASCHBECKEN

NIMES R



1 NIMES R

LAVABO
WASHBASIN
VASQUE
LAVABO
WASCHBECKEN

RAL: 9003

p. 106

2 BERGAMO

ENCIMERA
COUNTERTOP BASIN
PLAN VASQUE
PIANO LAVABO
WASCHTISCH

RAL: 9003

p. 76

3 EXOS S

MUEBLE PARA ENCIMERA
METALLIC STRUCTURE
MEUBLE SOUS VASQUE
MOBILE PER PIANO LAVABO
MÖBELSTRUKTUR FÜR WASCHPLATTEN

COLOR: NEGRO / BLACK

p. 90

ESTILIZA TU LAVABO
 ENHANCE YOUR WASHBASIN
 STYLISEZ VOTRE VASQUE
 STILIZZA IL TUO LAVABO
 GESTALTEN SIE IHR WASCHBECKEN

LAVABO
 WASHBASIN
 VASQUE
 LAVABO
 WASCHBECKEN

NIMES R



NIMES R

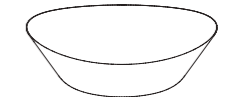

MEDIDAS / MEASURES / MESURES
 MISUR / ABMESSUNGEN

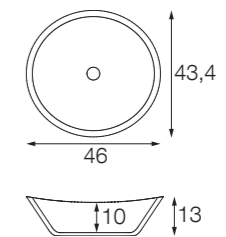

OPCIONES / OPTIONS /
 OPTIONS / OPZIONI / OPTIONEN

TEXTURA / TEXTURE / TEXTURE
 FINITURA / TEXTUR



lisa
 smooth
 lisse
 liscia
 glatt

VÁLVULAS / VALVES / VANNES
 SCARICO / ABLAUFVENTILE



PROPIEDADES / PROPERTIES / PROPRIÉTÉS / CARATTERISTICHE / EIGENSCHAFTEN



garantía 3 años *
 3 years guarantee *
 garantie 3 ans *
 garanzia 3 anni *
 3 Jahre Garantie *



fácil limpieza
 easy cleaning
 nettoyage facile
 facile pulizia
 leichte Reinigung



masa pigmentada
 pigmented mass
 masse pigmentée
 massa colorata
 Pigmentmasse



fácil instalación
 easy installation
 installation facile
 facile installazione
 einfache Installation



hecho en España
 made in Spain
 fabriqué en Espagne
 fatto in Spagna
 in Spanien hergestellt



bacteriostático
 bacteriostatic
 bactériostatique
 batteriostatico
 bakterienhemmend



no absorbente
 non-absorbent
 non absorbant
 non assorbente
 nicht absorbierend



certificado
 certificate
 certifié
 certificato
 Zertifikat

* **extension de garantía opcional** / * **optional warranty extension** / * **extension de garantie optionnelle** / * **estensione de garanzia opzionale** / * **optionale Garantieverlängerung**

COLORES Y ACABADOS / COLOURS AND FINISHES / COULEURS ET FINITIONS / COLORI E FINITURE / FARBEN UND AUSFÜHRUNGEN

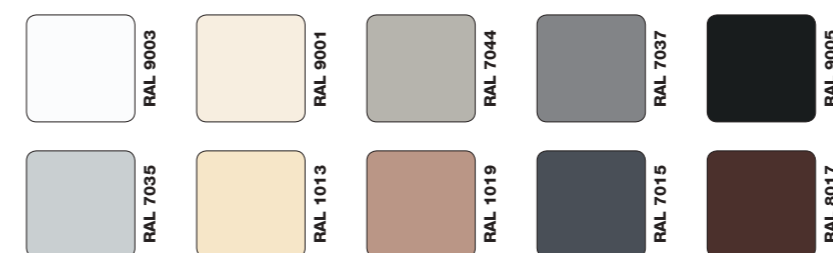

colores NCS
 NCS colours
 couleurs NCS
 colori NCS
 NCS Farben

colores RAL
 RAL colours
 couleurs RAL
 colori RAL
 RAL Farben

acabados DECO
 DECO finishes
 finitions DECO
 finiture DECO
 DECO Ausführungen

PERSONALIZA TU LAVABO
CUSTOMIZE YOUR WASHBASIN
PERSONNALISEZ VOTRE VASQUE
PERSONALIZZA IL TUO LAVABO
PERSONALISIEREN SIE IHR WASCHBECKEN

LAVABO
WASHBASIN
VASQUE
LAVABO
WASCHBECKEN

NICE



① NICE L

LAVABO CON TAPA COMPLETA
WASHBASIN WITH COMPLETE LID
VASQUE AVEC COUVERCLE COMPLÈTE
LAVABO CON COPERCHIO COMPLETO
WASCHBECKEN MIT KOMPLETTER ABDECKUNG
RAL: 9003
TECH: BLACK MARBLE

p. 108

② BERGAMO

ENCIMERA
COUNTERTOP BASIN
PLAN VASQUE
PIANO LAVABO
WASCHTISCH

TECH: BLACK MARBLE

p. 74

PERSONALIZA TU LAVABO
 CUSTOMIZE YOUR WASHBASIN
 PERSONNALISEZ VOTRE VASQUE
 PERSONALIZZA IL TUO LAVABO
 PERSONALISIEREN SIE IHR WASCHBECKEN

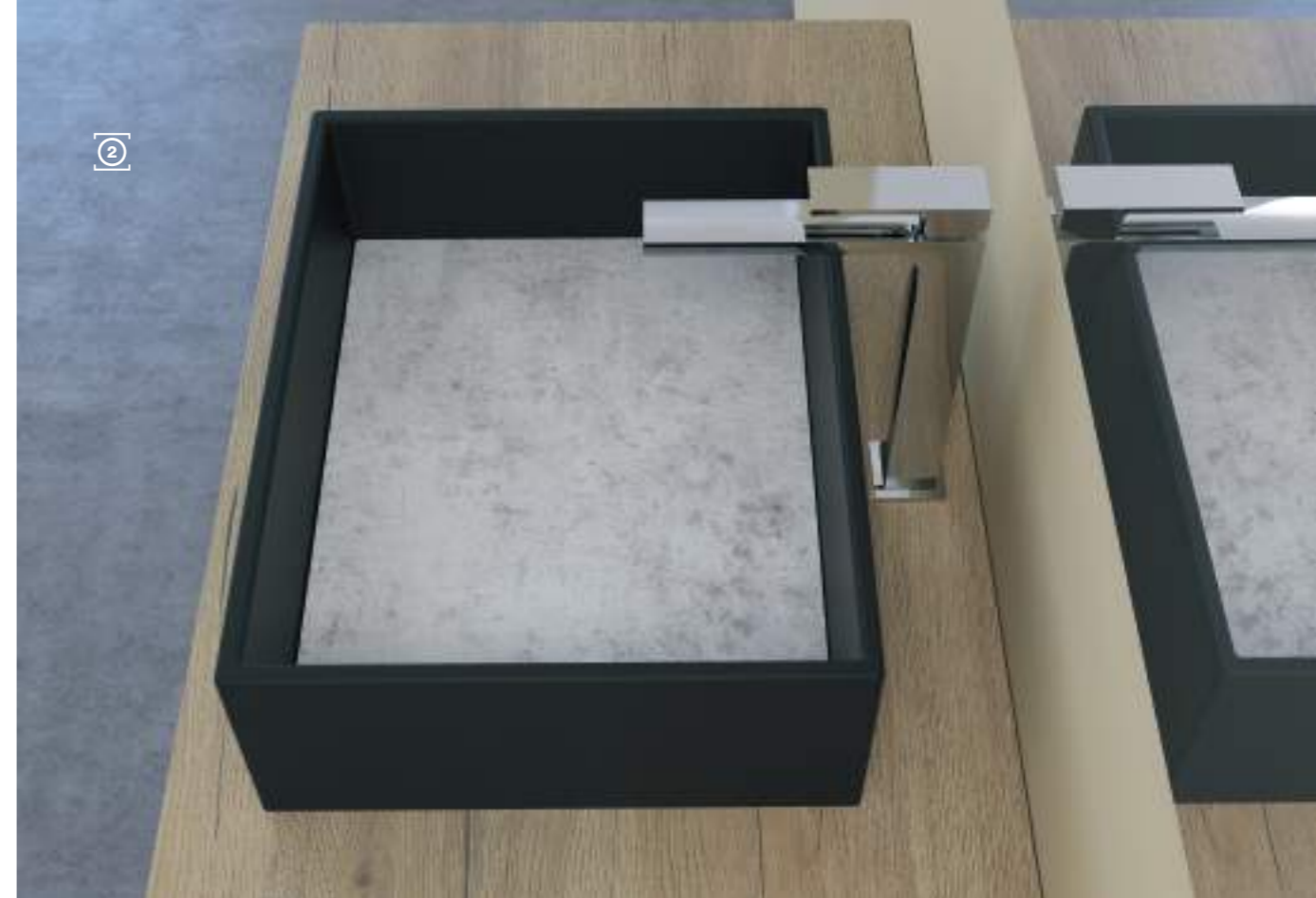

LAVABO
 WASHBASIN
 VASQUE
 LAVABO
 WASCHBECKEN

NICE

1 NICE L

CON TAPA COMPLETA
 WITH COMPLETE LID
 AVEC COUVERCLE COMPLÈTE
 CON COPERCHIO COMPLETO
 MIT KOMPLETTER ABDECKUNG
RAL: 9005
TECH: WHITE MARBLE

ENCIMERA: BERGAMO
 COUNTERTOP BASIN: BERGAMO
 PLAN VASQUE: BERGAMO
 PIANO LAVABO: BERGAMO
 WASCHTISCH: BERGAMO
TECH: WHITE MARBLE

p. 108

2 NICE S

CON TAPA COMPLETA
 WITH COMPLETE LID
 AVEC COUVERCLE COMPLÈTE
 CON COPERCHIO COMPLETO
 MIT KOMPLETTER ABDECKUNG
RAL: 9005
TECH: LIGHT CEMENT

ENCIMERA: BERGAMO
 COUNTERTOP BASIN: BERGAMO
 PLAN VASQUE: BERGAMO
 PIANO LAVABO: BERGAMO
 WASCHTISCH: BERGAMO
TECH: BLACK FOREST WOOD

p. 108

3 NICE L

CON TAPA PARCIAL
 WITH PARTIAL LID
 AVEC COUVERCLE PARTIELLE
 CON COPERCHIO PARZIALE
 MIT PARTIELLER ABDECKUNG
RAL: 9003
TECH: COLONIAL WOOD

ENCIMERA: BERGAMO
 COUNTERTOP BASIN: BERGAMO
 PLAN VASQUE: BERGAMO
 PIANO LAVABO: BERGAMO
 WASCHTISCH: BERGAMO
TECH: COLONIAL WOOD

p. 108

4 NICE L

CON TAPA COMPLETA
 WITH COMPLETE LID
 AVEC COUVERCLE COMPLÈTE
 CON COPERCHIO COMPLETO
 MIT KOMPLETTER ABDECKUNG
RAL: 9003
TECH: BLACK MARBLE

ENCIMERA: BERGAMO
 COUNTERTOP BASIN: BERGAMO
 PLAN VASQUE: BERGAMO
 PIANO LAVABO: BERGAMO
 WASCHTISCH: BERGAMO
TECH: BLACK MARBLE

p. 108

PERSONALIZA TU LAVABO
CUSTOMIZE YOUR WASHBASIN
PERSONNALISEZ VOTRE VASQUE
PERSONALIZZA IL TUO LAVABO
PERSONALISIEREN SIE IHR WASCHBECKEN

LAVABO
WASHBASIN
VASQUE
LAVABO
WASCHBECKEN

NICE



NICE S

MEDIDAS / MEASURES / MESURES
MISUR / ABMESSUNGEN

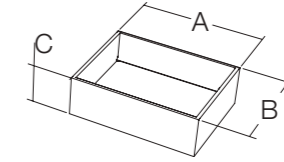

A = 45,5 cm B = 35,5 cm C = 10,5 cm

NICE L

MEDIDAS / MEASURES / MESURES
MISUR / ABMESSUNGEN

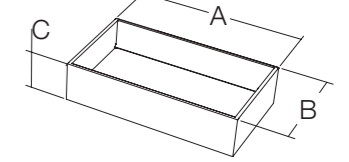

A = 61 cm B = 35,5 cm C = 11,5 cm

OPCIONES / OPTIONS / OPTIONS / OPZIONI / OPTIONEN

TAPA COMPLETA O PARCIAL / COMPLETE OR PARTIAL LID / COUVERCLE
COMPLÈTE OU PARTIELLE / COPERCHIO COMPLETO O PARZIALE /
KOMPLLETTE ODER PARTIELLE ABDECKUNG

COMPLETA / COMPLETE
COMPLÈTE / COMPLETO / KOMPLETT

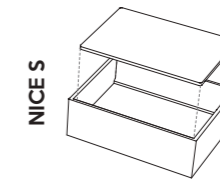

NICE S

COMPLETA / COMPLETE
COMPLÈTE / COMPLETO / KOMPLETT

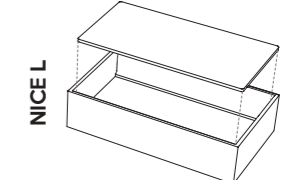

NICE L

PARCIAL / PARTIAL
PARTIELLE / PARZIALE / PARTIELL

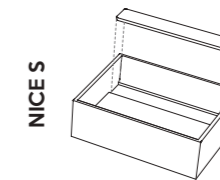

NICE S

PARCIAL / PARTIAL
PARTIELLE / PARZIALE / PARTIELL

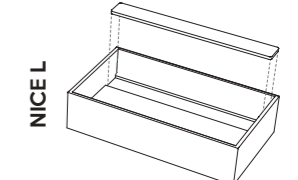

NICE L

Lavabos disponibles en colores estandar, RAL y NCS. Tapas disponibles también en colores TECH.

Washbasins available in standard colours, RAL and NCS. Lids available also in TECH colours.

Plans vasques disponibles en couleurs standard, RAL et NCS. Couvercles disponibles aussi en couleurs TECH.

Lavabi disponibili nei colori standard, RAL e NCS. Coperchi disponibili anche nei colori TECH.

Waschbecken in Standard, RAL und NCS Farben verfügbar. Abdeckungen auch in TECH Farben verfügbar.

TEXTURA / TEXTURE / TEXTURE
FINITURA / TEXTUR



lisa
smooth
lisse
liscia
glatt

VÁLVULAS / VALVES / VANNES
SCARICO / ABLAUFVENTILE



PROPIEDADES / PROPERTIES / PROPRIÉTÉS / CARATTERISTICHE / EIGENSCHAFTEN



garantía 3 años *
3 years guarantee *
garantie 3 ans *
garanzia 3 anni *
3 Jahre Garantie *



fácil limpieza
easy cleaning
nettoyage facile
facile pulizia
leichte Reinigung



masa pigmentada
pigmented mass
masse pigmentée
massa colorata
Pigmentmasse



fácil instalación
easy installation
installation facile
facile installazione
einfache Installation



hecho en España
made in Spain
fabriqué en Espagne
fatto in Spagna
in Spanien hergestellt



bacteriostático
bacteriostatic
bactériostatique
batteriostatico
bakterienhemmend



no absorbente
non-absorbent
non absorbant
non assorbente
nicht absorbierend



certificado
certificate
certifié
certificato
Zertifikat

* extension de garantía opcional / * optional warranty extension / * extension de garantie optionnelle / * estensione de garanzia opzionale / * optionale Garantieverlängerung

COLORES Y ACABADOS / COLOURS AND FINISHES / COULEURS ET FINITIONS / COLORI E FINITURE / FARBEN UND AUSFÜHRUNGEN



RAL 9003



RAL 9001



RAL 7044



RAL 7037



RAL 9005



RAL 7035

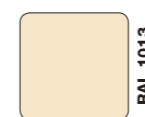

RAL 1013

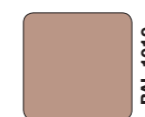

RAL 1019



RAL 7015



RAL 8017



NATURAL COLOUR SYSTEM

colores NCS
NCS colours
couleurs NCS
colori NCS
NCS Farben



colores RAL
RAL colours
couleurs RAL
colori RAL
RAL Farben

LAVABO
WASHBASIN
VASQUE
LAVABO
WASCHBECKEN

CANNES

ESTILIZA TU LAVABO
ENHANCE YOUR WASHBASIN
STYLISEZ VOTRE VASQUE
STILIZZA IL TUO LAVABO
GESTALTEN SIE IHR WASCHBECKEN



1 CANNES

LAVABO
WASHBASIN
VASQUE
LAVABO
WASCHBECKEN

RAL: 9003

p. 116

2 BERGAMO

ENCIMERA
COUNTERTOP BASIN
PLAN VASQUE
PIANO LAVABO
WASCHTISCH

TECH: GREY STONE

p. 76

3 CENTRAL

PLATO DE DUCHA
SHOWER TRAY
RECEVEUR DE DOUCHE
PIATTO DOCCIA
DUSCHWANNE

REJILLA: ESTÁNDAR
GRID: STANDARD
GRILLE: STANDARD
GRIGLIA: STANDARD
ABLAUGGITTER: STANDARD

RAL: 9003

p. 154

ESTILIZA TU LAVABO
 ENHANCE YOUR WASHBASIN
 STYLISEZ VOTRE VASQUE
 STILIZZA IL TUO LAVABO
 GESTALTEN SIE IHR WASCHBECKEN

LAVABO
 WASHBASIN
 VASQUE
 LAVABO
 WASCHBECKEN

CANNES



CANNES

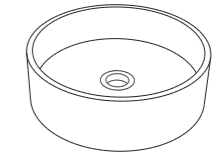

MEDIDAS / MEASURES / MESURES
 MISUR / ABMESSUNGEN

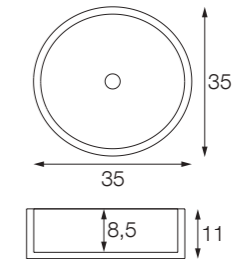

OPCIONES / OPTIONS /
 OPTIONS / OPZIONI / OPTIONEN

TEXTURA / TEXTURE / TEXTURE
 FINITURA / TEXTUR



lisa
 smooth
 lisse
 liscia
 glatt

VÁLVULAS / VALVES / VANNES
 SCARICO / ABLAUFVENTILE



PROPIEDADES / PROPERTIES / PROPRIÉTÉS / CARATTERISTICHE / EIGENSCHAFTEN



garantía 3 años *
 3 years guaranteee *
 garantie 3 ans *
 garanzia 3 anni *
 3 Jahre Garantie *



fácil limpieza
 easy cleaning
 nettoyage facile
 facile pulizia
 leichte Reinigung



masa pigmentada
 pigmented mass
 masse pigmentée
 massa colorata
 Pigmentmasse



fácil instalación
 easy installation
 installation facile
 facile installazione
 einfache Installation



hecho en España
 made in Spain
 fabriqué en Espagne
 fatto in Spagna
 in Spanien hergestellt



bacteriostático
 bacteriostatic
 bactériostatique
 batteriostatico
 bakterienhemmend



no absorbente
 non-absorbent
 non absorbant
 non assorbente
 nicht absorbierend



certificado
 certificate
 certifié
 certificato
 Zertifikat

* extension de garantía opcional / * optional warranty extension / * extension de garantie optionnelle / * estensione de garanzia opzionale / * optionale Garantieverlängerung

COLORES Y ACABADOS / COLOURS AND FINISHES / COULEURS ET FINITIONS / COLORI E FINITURE / FARBEN UND AUSFÜHRUNGEN

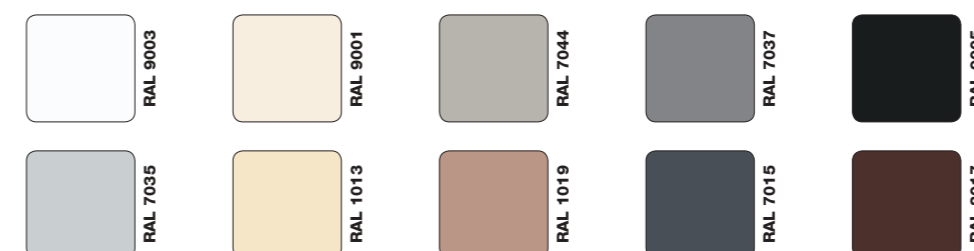

colores NCS
 NCS colours
 couleurs NCS
 colori NCS
 NCS Farben



colores RAL
 RAL colours
 couleurs RAL
 colori RAL
 RAL Farben

LAVABO
WASHBASIN
VASQUE
LAVABO
WASCHBECKEN

MARSELLA

PERSONALIZA TU LAVABO
CUSTOMIZE YOUR WASHBASIN
PERSONNALISEZ VOTRE VASQUE
PERSONALIZZA IL TUO LAVABO
PERSONALISIEREN SIE IHR WASCHBECKEN



① MARSELLA L

LAVABO
WASHBASIN
VASQUE
LAVABO
WASCHBECKEN

RAL: 9003

p. 120

② BERGAMO

ENCIMERA
COUNTERTOP BASIN
PLANO VASQUE
PIANO LAVABO
WASCHTISCH

RAL: 9003

p. 76

③ CENTRAL

PLATO DE DUCHA
SHOWER TRAY
RECEVEUR DE DOUCHE
PIATTO DOCCIA
DUSCHWANNE

REJILLA: LACADA
GRID: LACQUERED
GRILLE: LAQUÉE
GRIGLIA: LACCATA
ABLAUFGITTER: LACKIERT

RAL: 9003

p. 154

ESTILIZA TU LAVABO
ENHANCE YOUR WASHBASIN
STYLISEZ VOTRE VASQUE
STILIZZA IL TUO LAVABO
GESTALTEN SIE IHR WASCHBECKEN

LAVABO
WASHBASIN
VASQUE
LAVABO
WASCHBECKEN

MARSELLA



PROPIEDADES / PROPERTIES / PROPRIÉTÉS / CARATTERISTICHE / EIGENSCHAFTEN



garantía 3 años *
3 years guarantee *
garantie 3 ans *
garanzia 3 anni *
3 Jahre Garantie *



fácil limpieza
easy cleaning
nettoyage facile
facile pulizia
leichte Reinigung



no absorbente
non-absorbent
non absorbant
non assorbente
nicht absorbierend



hecho en España
made in Spain
fabriqué en Espagne
fatto in Spagna
in Spanien hergestellt



bacteriostático
bacteriostatic
bactériostatique
batteriostatico
bakterienhemmend



certificado
certificate
certifié
certificato
Zertifikat



masa pigmentada
pigmented mass
masse pigmentée
massa colorata
Pigmentmasse



fácil instalación
easy installation
installation facile
facile installazione
einfache Installation

* **extensión de garantía opcional** / * **optional warranty extension** / * **extension de garantie optionnelle**
/ * **estensione de garanzia opzionale** / * **optionale Garantieverlängerung**

VÁLVULAS / VALVES / VANNES SCARICO / ABLAUFVENTILE



TEXTURA / TEXTURE / TEXTURE FINITURA / TEXTUR



lisa
smooth
lisse
liscia
glatt

MARSELLA S

MEDIDAS / MEASURES / MESURES MISUR / ABMESSUNGEN



MARSELLA L

MEDIDAS / MEASURES / MESURES MISUR / ABMESSUNGEN

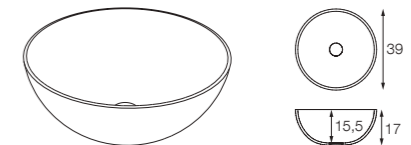

COLORES Y ACABADOS / COLOURS AND FINISHES / COULEURS ET FINITIONS / COLORI E FINITURE / FARBEN UND AUSFÜHRUNGEN



colores NCS
NCS colours
couleurs NCS
colori NCS
NCS Farben

colores RAL
RAL colours
couleurs RAL
colori RAL
RAL Farben

acabados DECO
DECO finishes
finitions DECO
finiture DECO
DECO Ausführungen



PLATOS DE DUCHA
SHOWER TRAYS
RECEVEURS DE DOUCHE
PIATTI DOCCIA
DUSCHWANNEN

PLATO DE DUCHA
SHOWER TRAY
RECEVEUR DE DOUCHE
PIATTO DOCCIA
DUSCHWANNE

FABRICACIÓN A MEDIDA
CUSTOMIZED MANUFACTURE
FABRIQUE SUR MESURE
PRODUZIONE FATTA SU MISURA
FERTIGUNG NACH MAß

SOFTUM

126



1 SOFTUM

PLATO DE DUCHA
SHOWER TRAY
RECEVEUR DE DOUCHE
PIATTO DOCCIA
DUSCHWANNE

RAL: 9003

p. 126

2 SICILIA

ENCIMERA
COUNTERTOP BASIN
PLAN VASQUE
PIANO LAVABO
WASCHTISCH

TECH: DARK CEMENT

p. 64

127

AGG
BATHROOM



FABRICACIÓN A MEDIDA
CUSTOMIZED MANUFACTURE
FABRIQUE SUR MESURE
PRODUZIONE FATTA SU MISURA
FERTIGUNG NACH MAß

PLATO DE DUCHA
SHOWER TRAY
RECEVEUR DE DOUCHE
PIATTO DOCCIA
DUSCHWANNE

SOFTUM



HOJA TÉCNICA / TECHNICAL DATA SHEET
FICHE TECHNIQUE / SCHEDA TECNICA / DATENBLATT

FABRICACIÓN A MEDIDA / CUSTOMIZED MANUFACTURE
FABRIQUÉ SUR MESURE / PRODUZIONE FATTA SU MISURA / FERTIGUNG NACH MAß

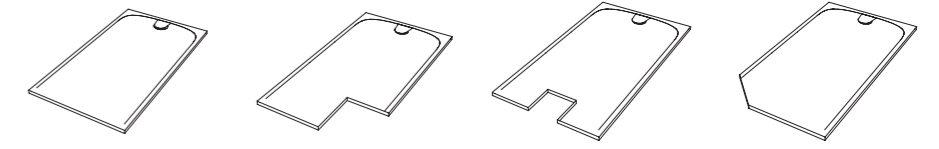

Diseño adaptable a medidas intermedias a las estándar o a cortes especiales para salvar esquinas, columnas y ángulos.

Adaptable design to intermediate measures to the standard ones or to special cuts to save the corners, columns and angles.

Design adaptable aux mesures intermédiaires aux coupes standard, ou coupes spéciales pour surmonter les coins, les colonnes et les angles.

Design adattabile alle misure intermedie a tagli standard o tagli speciali per riporre spigolo, colonna e angoli. Anpassungsfähiges Design für Zwischenmessungen die von Standardmaßen abweichen oder Sonderschnitte, um Ecken, Säulen und Winkel zu berücksichtigen

TEXTURA / TEXTURE
TEXTURE / FINITURA / TEXTUR



sand antideslizante
non-slip sand
sand anti-dérapant
sand antiscivolo
rutschfest sand
class 3
class 3 / classe 3
classe 3 / class 3

VÁLVULAS / VALVES
VANNES / SIFONI / ABLAUFVENTILE



PROPIEDADES / PROPERTIES / PROPRIÉTÉS / CARATTERISTICHE / EIGENSCHAFTEN



garantía 3 años *
3 years guarantee *
garantie 3 ans *
garanzia 3 anni *
3 Jahre Garantie *



ecofriendly
ecofriendly
ecofriendly
ecofriendly



ligero
light weight
léger
leggero
leichtgewicht



hecho en España
made in Spain
fabriqué en Espagne
fatto in Spagna
in Spanien hergestellt



fácil limpieza
easy cleaning
nettoyage facile
facile pulizia
leichte Reinigung



no absorbente
non-absorbent
non absorbant
non assorbente
nicht absorbierend



sifón accesible
accessible siphon
siphon accessible
sifone accessibile
zugänglicher Siphon



certificado
certificat
certifié
certificato
Zertifikat



bacteriostático
bacteriostatic
bactériostatique
batteriostatico
bakterienhemmend



masa pigmentada
pigmented mass
masse pigmentée
massa colorata
Pigmentmasse



fácil instalación
easy installation
installation facile
facile installazione
einfache Installation



antideslizante
non-slip
anti-dérapant
antiscivolo
rutschfest

MEDIDAS ESTÁNDAR DISPONIBLES Y DISTANCIA A VÁLVULA
STANDARD MEASURES AVAILABLE AND DISTANCE TO VALVE / MESURES STANDARD DISPONIBLES ET DISTANCE À LA VANNE
MISURE STANDARD DISPONIBILI E DISTANZA DEL SIFONE / VERFÜGBARE STANDARDGRÖßEN UND ENTFERNUNG ZUM ABLAUF

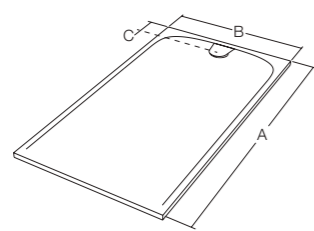

		A													
		100	110	120	130	140	150	160	170	180	190	200			
B	70	12'5	12'5	12'5	12'5	12'5	12'5	12'5	12'5	12'5	12'5	12'5	12'5	C	
	80	12'5	12'5	12'5	12'5	12'5	12'5	12'5	12'5	12'5	12'5	12'5	12'5	C	
	90	12'5	12'5	12'5	12'5	12'5	12'5	12'5	12'5	12'5	12'5	12'5	12'5	C	

COLORES Y ACABADOS / COLOURS AND FINISHES / COULEURS ET FINITIONS / COLORI E FINITURE / FARBEN UND AUSFÜHRUNGEN



RAL 9003



RAL 9001



RAL 7044



RAL 7037



RAL 9005



RAL 7035



RAL 1013

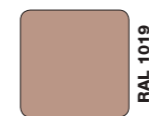

RAL 1019



RAL 7015



RAL 8017

colores NCS
NCS colours
couleurs NCS
colori NCS
NCS Farben

colores RAL
RAL colours
couleurs RAL
colori RAL
RAL Farben

* extension de garantía opcional / optional warranty extension / extension de garantie optionnelle / estensione de garanzia opzionale / optionale Garantieverlängerung

FABRICACIÓN A MEDIDA
CUSTOMIZED MANUFACTURE
FABRIQUE SUR MESURE
PRODUZIONE FATTA SU MISURA
FERTIGUNG NACH MAß

PLATO DE DUCHA
SHOWER TRAY
RECEVEUR DE DOUCHE
PIATTO DOCCIA
DUSCHWANNE

LUXE

132



① LUXE

PLATO DE DUCHA
SHOWER TRAY
RECEVEUR DE DOUCHE
PIATTO DOCCIA
DUSCHWANNE

TAPETA
RESIN COVER
LAQUÉE
LACCATA
ABDECKUNG

RAL: 7037

p. 132

② NAPOLI

ENCIMERA
COUNTERTOP BASIN
PLAN VASQUE
PIANO LAVABO
WASCHTISCH

RAL: 7037

p. 68

③ BALDA

BALDA
SHELF
TABLETTE
RIPIANO
ABLAGE

RAL: 9003

p. 84

133





FABRICACIÓN A MEDIDA
CUSTOMIZED MANUFACTURE
FABRIQUE SUR MESURE
PRODUZIONE FATTA SU MISURA
FERTIGUNG NACH MAß

PLATO DE DUCHA
SHOWER TRAY
RECEVEUR DE DOUCHE
PIATTO DOCCIA
DUSCHWANNE

LUXE



HOJA TÉCNICA / TECHNICAL DATA SHEET
FICHE TECHNIQUE / SCHEDA TECNICA / DATENBLATT

FABRICACIÓN A MEDIDA / CUSTOMIZED MANUFACTURE
FABRIQUE SUR MESURE / PRODUZIONE FATTA SU MISURA / FERTIGUNG NACH MAß

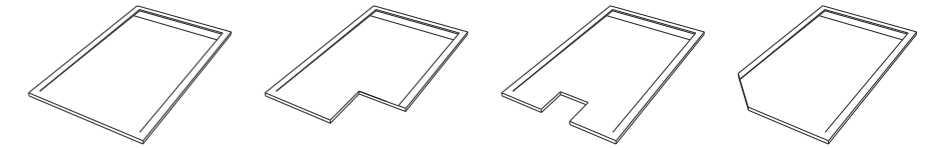

Diseño adaptable a medidas intermedias a las estándar o a cortes especiales para salvar esquinas, columnas y ángulos.
Adaptable design to intermediate measures to the standard ones or to special cuts to save the corners, columns and angles.

Design adaptable aux mesures intermédiaires aux coupes standard, ou coupes spéciales pour surmonter les coins, les colonnes et les angles.

Design adattabile alle misure intermedie a tagli standard o tagli speciali per riporre spigolo, colonne e angoli. Anpassungsfähiges Design für Zwischenmessungen die von Standardmaßen abweichen oder Sonderschnitte, um Ecken, Säulen und Winkel zu berücksichtigen

TEXTURA / TEXTURE
TEXTURE / FINITURA / TEXTUR



pizarra antideslizante
non-slip slate
ardoise anti-dérapant
ardesia antiscivolo
rutschfest Schiefer
class 2
class 2 / classe 2
classe 2 / class 2

VÁLVULAS / VALVES
VANNES / SIFONI / ABLAUFVENTILE



REJILLAS / GRIDS / GRILLES / GRIGLIE / ABLAUFGITTER



estándar
standard standard
standard standard

lacada
lacquered laquée
laccata lackiert

tapeta
resin cover couvercle
tapeta Abdeckung

Las rejillas y tapeta están disponibles en todos los colores
Grids and resin cover are available in all the colours

Les grilles et couvercle sont disponibles dans toutes les couleurs

Le griglie e tapeta sono disponibili in tutti i colori

Die Ablaufgitter und die Abdeckung sind in allen Farben verfügbar

PROPIEDADES / PROPERTIES / PROPRIÉTÉS / CARATTERISTICHE / EIGENSCHAFTEN

garantía 3 años *
3 years guarantee *
garantie 3 ans *
garanzia 3 anni *
3 Jahre Garantie *

ecofriendly
ecofriendly
ecofriendly
ecofriendly

ligero
light weight
léger
leggero
leichtgewichtig

hecho en España
made in Spain
fabriqué en Espagne
fatto in Spagna
in Spanien hergestellt

fácil limpieza
easy cleaning
nettoyage facile
facile pulizia
leichte Reinigung

no absorbente
non-absorbent
non absorbant
non assorbente
nicht absorbierend

sifón accesible
accessible siphon
siphon accessible
sifone accessibile
zugänglicher Siphon

certificado
certificate
certifié
certificato
Zertifikat

bacteriostático
bacteriostatic
bactériostatique
batteriostatico
bakterienhemmend

masa pigmentada
pigmented mass
masse pigmentée
massa colorata
Pigmentmasse

fácil instalación
easy installation
installation facile
facile installazione
einfache Installation

antideslizante
non-slip
anti-dérapant
antiscivolo
rutschfest

MEDIDAS ESTÁNDAR DISPONIBLES Y DISTANCIA A VÁLVULA
STANDARD MEASURES AVAILABLE AND DISTANCE TO VALVE / MESURES STANDARD DISPONIBLES ET DISTANCE À LA VANNE
MISURE STANDARD DISPONIBILI E DISTANZA DEL SIFONE / VERFÜGBARE STANDARDGRÖßEN UND ENTFERNUNG ZUM ABLAUF

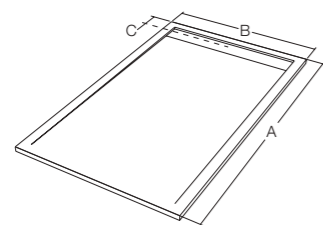

	A											C	
	80	90	100	110	120	130	140	150	160	170	180		190
70	12	12	12	12	12	12	12	12	12	12	12	12	12
80	12	12	12	12	12	12	12	12	12	12	12	12	12
90		12	12	12	12	12	12	12	12	12	12	12	12
100			12	12	12	12	12	12	12	12	12	12	12

COLORES Y ACABADOS / COLOURS AND FINISHES / COULEURS ET FINITIONS / COLORI E FINITURE / FARBEN UND AUSFÜHRUNGEN

colores NCS
NCS colours
couleurs NCS
colori NCS
NCS Farben

colores RAL
RAL colours
couleurs RAL
colori RAL
RAL Farben

* extensión de garantía opcional / optional warranty extension / extension de garantie optionnelle / estensione de garanzia opzionale / optionale Garantieverlängerung

FABRICACIÓN A MEDIDA
CUSTOMIZED MANUFACTURE
FABRIQUE SUR MESURE
PRODUZIONE FATTA SU MISURA
FERTIGUNG NACH MAß

PLATO DE DUCHA
SHOWER TRAY
RECEVEUR DE DOUCHE
PIATTO DOCCIA
DUSCHWANNE

FLAT

138



① FLAT

PLATO DE DUCHA
SHOWER TRAY
RECEVEUR DE DOUCHE
PIATTO DOCCIA
DUSCHWANNE

REJILLA: LACADA
GRID: LACQUERED
GRILLE: LAQUÉE
GRIGLIA: LACCATA
ABLAUFGITTER: LACKIERT

RAL: 9003

p. 138

② PANEL

PANEL DE REVESTIMIENTO
WALL PANEL
PANNEAU MURAL
PANNELLO DI REVESTIMENTO
VERKLEIDUNGSPLATTE

TECH: SUNRISE WOOD

p. 164



③ PANEL

PANEL DE REVESTIMIENTO
WALL PANEL
PANNEAU MURAL
PANNELLO DI REVESTIMENTO
VERKLEIDUNGSPLATTE

TECH: BONE STONE

p. 164

④ MILANO

ENCIMERA
COUNTERTOP BASIN
PLAN VASQUE
PIANO LAVABO
WASCHTISCH

RAL: 9003

p. 30

139



FABRICACIÓN A MEDIDA
CUSTOMIZED MANUFACTURE
FABRIQUE SUR MESURE
PRODUZIONE FATTA SU MISURA
FERTIGUNG NACH MAß

PLATO DE DUCHA
SHOWER TRAY
RECEVEUR DE DOUCHE
PIATTO DOCCIA
DUSCHWANNE

FLAT

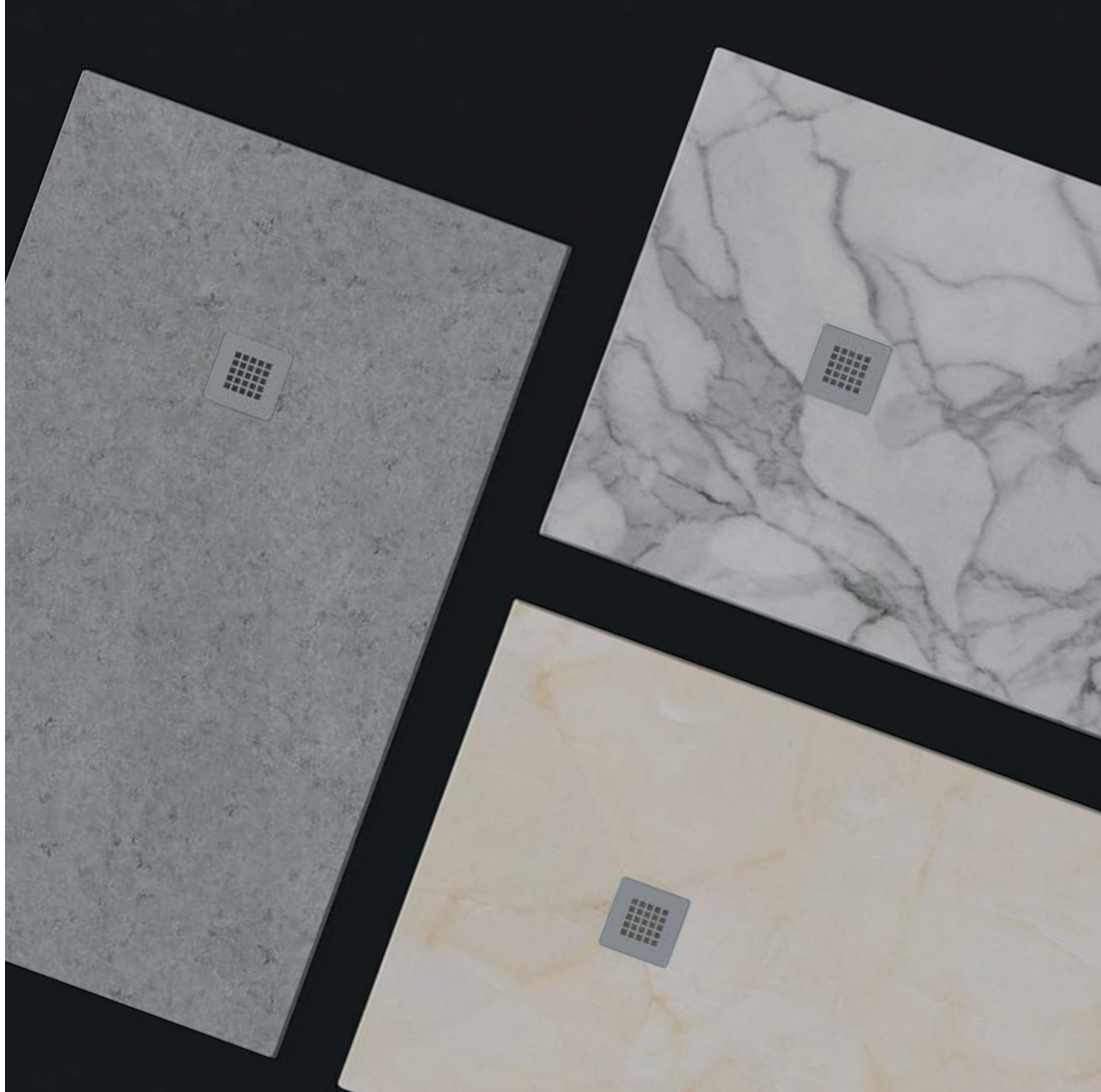

MEDIDAS ESTÁNDAR DISPONIBLES Y DISTANCIA A VÁLVULA
STANDARD MEASURES AVAILABLE AND DISTANCE TO VALVE / MESURES STANDARD DISPONIBLES ET DISTANCE À LA VANNE
MISURE STANDARD DISPONIBILI E DISTANZA DEL SIFONE / VERFÜGBARE STANDARDGRÖßEN UND ENTFERNUNG ZUM ABLAUF

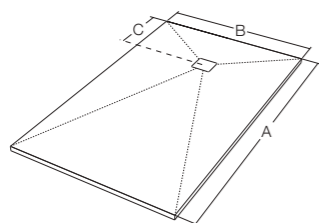

		A														
		80	90	100	110	120	130	140	150	160	170	180	190	200		
B	70	40	40	40	40	40	40	40	40	40	40	40	50	50		
	80	40	40	40	40	40	40	40	40	40	40	40	50	50		
													C			
													40	50		

HOJA TÉCNICA / TECHNICAL DATA SHEET
FICHE TECHNIQUE / SCHEDA TECNICA / DATENBLATT

FABRICACIÓN A MEDIDA / CUSTOMIZED MANUFACTURE
FABRIQUE SUR MESURE / PRODUZIONE FATTA SU MISURA / FERTIGUNG NACH MAß

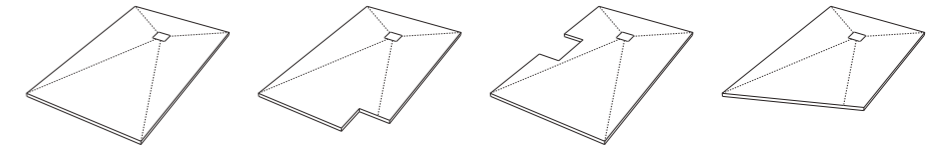

Diseño adaptable a medidas intermedias a las estándar o a cortes especiales para salvar esquinas, columnas y ángulos.
Adaptable design to intermediate measures to the standard ones or to special cuts to save the corners, columns and angles.

Design adaptable aux mesures intermédiaires aux coupes standard, ou coupes spéciales pour surmonter les coins, les colonnes et les angles.

Design adattabile alle misure intermedie a tagli standard o tagli speciali per riporre spigolo, colonne e angoli.
Anpassungsfähiges Design für Zwischenmessungen die von Standardmaßen abweichen oder Sonderschnitte, um Ecken, Säulen und Winkel zu berücksichtigen

TEXTURA / TEXTURE
TEXTURE / FINITURA / TEXTUR

lisa antideslizante
non-slip smooth
lisse anti-dérapant
liscia antiscivolo
rutschfest glatt
clase 3
class 3 / classe 3
classe 3 / class 3

REJILLAS / GRIDS
GRILLES / GRIGLIE / ABLAUFGITTER



estándar
standard standard
standard standard

lacada
lacquered laquée
laccata lackiert

VÁLVULAS / VALVES
VANNES / SIFONI / ABLAUFVENTILE



Las rejillas están disponibles en todos los colores
Grids are available in all the colours
Les grilles sont disponibles dans toutes les couleurs
Le griglie sono disponibili in tutti i colori
Die Ablaufgitter sind in allen Farben verfügbar

PROPIEDADES / PROPERTIES / PROPRIÉTÉS / CARATTERISTICHE / EIGENSCHAFTEN

garantía 3 años *
3 years guarantee *
garantie 3 ans *
garanzia 3 anni *
3 Jahre Garantie *

ecofriendly
ecofriendly
ecofriendly
ecofriendly
ecofriendly

ligero
light weight
léger
leggero
leichtgewichtig

hecho en España
made in Spain
fabriqué en Espagne
fatto in Spagna
in Spanien hergestellt

fácil limpieza
easy cleaning
nettoyage facile
facile pulizia
leichte Reinigung

no absorbente
non-absorbent
non absorbant
non assorbente
nicht absorbierend

sifón accesible
accessible siphon
siphon accessible
sifone accessibile
zugänglicher Siphon

certificado
certificate
certifié
certificato
Zertifikat

bacteriostático
bacteriostatic
bactériostatique
batteriostatico
bakterienhemmend

masa pigmentada
pigmented mass
masse pigmentée
massa colorata
Pigmentmasse

fácil instalación
easy installation
installation facile
facile installazione
einfache Installation

antideslizante
non-slip
anti-dérapant
antiscivolo
rutschfest

COLORES Y ACABADOS / COLOURS AND FINISHES / COULEURS ET FINITIONS / COLORI E FINITURE / FARBEN UND AUSFÜHRUNGEN

	RAL 9003		RAL 9001		RAL 7044		RAL 7037		RAL 9005		NCS		RAL		TECH		DECO
	RAL 7035		RAL 1013		RAL 1019		RAL 7015		RAL 8017	colores NCS NCS colours couleurs NCS colori NCS NCS Farben	colores RAL RAL colours couleurs RAL colori RAL RAL Farben	acabados TECH finishes finitions TECH finiture TECH	acabados DECO finishes finitions DECO finiture DECO				

* extensión de garantía opcional / optional warranty extension / extension de garantie optionnelle / estensione de garanzia opzionale / optionale Garantieverlängerung

FABRICACIÓN A MEDIDA
CUSTOMIZED MANUFACTURE
FABRIQUE SUR MESURE
PRODUZIONE FATTA SU MISURA
FERTIGUNG NACH MAß

PLATO DE DUCHA
SHOWER TRAY
RECEVEUR DE DOUCHE
PIATTO DOCCIA
DUSCHWANNE

CLASSIC



1 CLASSIC

PLATO DE DUCHA
SHOWER TRAY
RECEVEUR DE DOUCHE
PIATTO DOCCIA
DUSCHWANNE

REJILLA: LACADA
GRID: LACQUERED
GRILLE: LAQUÉE
GRIGLIA: LACCATA
ABLAUFGITTER: LACKIERT

TECH: SUNRISE WOOD

p. 142

2 VERONA

CONSOLA
CONSOLE
CONSOLE MURALE
CONSOLE
KONSOLE

TECH: WHITE MARBLE

p. 54

3 BERGAMO

ENCIMERA
COUNTERTOP BASIN
PLAN VASQUE
PIANO LAVABO
WASCHTISCH

TECH: SUNRISE WOOD

p. 76

4 PANEL

PANEL DE REVESTIMIENTO
WALL PANEL
PANNEAU MURAL
PANNELLO DI REVESTIMENTO
VERKLEIDUNGSPLATTE

TECH: SUNRISE WOOD

p. 164

CLASSIC

PLATO DE DUCHA
SHOWER TRAY
RECEVEUR DE DOUCHE
PIATTO DOCCIA
DUSCHWANNE

FABRICACIÓN A MEDIDA
CUSTOMIZED MANUFACTURE
FABRIQUE SUR MESURE
PRODUZIONE FATTA SU MISURA
FERTIGUNG NACH MAß



FABRICACIÓN A MEDIDA
CUSTOMIZED MANUFACTURE
FABRIQUE SUR MESURE
PRODUZIONE FATTA SU MISURA
FERTIGUNG NACH MAß

PLATO DE DUCHA
SHOWER TRAY
RECEVEUR DE DOUCHE
PIATTO DOCCIA
DUSCHWANNE

CLASSIC



MEDIDAS ESTÁNDAR DISPONIBLES Y DISTANCIA A VÁLVULA
STANDARD MEASURES AVAILABLE AND DISTANCE TO VALVE / MESURES STANDARD DISPONIBLES ET DISTANCE À LA VANNE
MISURE STANDARD DISPONIBILI E DISTANZA DEL SIFONE / VERFÜGBARE STANDARDGRÖßEN UND ENTFERNUNG ZUM ABLAUF

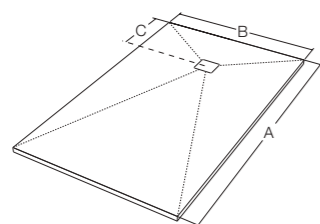

		A																
		80	90	100	110	120	130	140	150	160	170	180	190	200	210	220		
B	70	40	40	40	40	40	40	40	40	40	40	40	50	50	50	50		
	75	40	40	40	40	40	40	40	40	40	40	40	50	50	50	50		
	80	40	40	40	40	40	40	40	40	40	40	40	50	50	50	50		
	90	45	40	40	40	40	40	40	40	40	40	40	50	50	50	50		
		100	50	40	40	40	40	40	40	40	40	50	50	50	50	C		

HOJA TÉCNICA / TECHNICAL DATA SHEET
FICHE TECHNIQUE / SCHEDA TECNICA / DATENBLATT

FABRICACIÓN A MEDIDA / CUSTOMIZED MANUFACTURE
FABRIQUE SUR MESURE / PRODUZIONE FATTA SU MISURA / FERTIGUNG NACH MAß

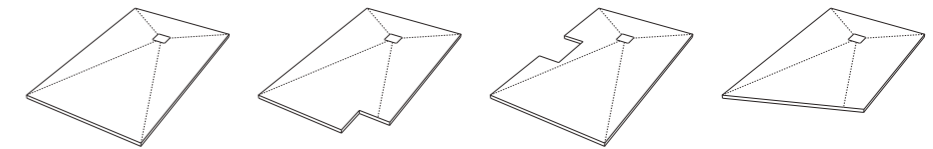

Diseño adaptable a medidas intermedias a las estándar o a cortes especiales para salvar esquinas, columnas y ángulos.
Adaptable design to intermediate measures to the standard ones or to special cuts to save the corners, columns and angles.
Design adaptable aux mesures intermédiaires aux coupes standard, ou coupes spéciales pour surmonter les coins, les colonnes et les angles.
Design adattabile alle misure intermedie a tagli standard o tagli speciali per riporre spigolo, colonne e angoli.
Anpassungsfähiges Design für Zwischenmessungen die von Standardmaßen abweichen oder Sonderschnitte, um Ecken, Säulen und Winkel zu berücksichtigen

TEXTURA / TEXTURE
TEXTURE / FINITURA / TEXTUR

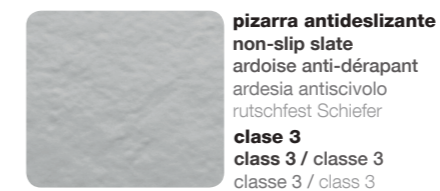

pizarra antideslizante
non-slip slate
ardoise anti-dérapant
ardesia antiscivolo
rutschfest Schiefer
clase 3
class 3 / classe 3
class 3 / class 3

REJILLAS / GRIDS
GRILLES / GRIGLIE / ABLAUFGITTER



estándar
standard standard
lacada
lacquered laquée
laccata lackiert

VÁLVULAS / VALVES
VANNES / SIFONI / ABLAUFVENTILE



Las rejillas están disponibles en todos los colores
Grids are available in all the colours
Les grilles sont disponibles dans toutes les couleurs
Le griglie sono disponibili in tutti i colori
Die Ablaufgitter sind in allen Farben verfügbar

PROPIEDADES / PROPERTIES / PROPRIÉTÉS / CARATTERISTICHE / EIGENSCHAFTEN

garantía 3 años * 3 years guarantee * garantie 3 ans * garanzia 3 anni * 3 Jahre Garantie *	ecofriendly ecofriendly ecofriendly ecofriendly	ligero light weight léger leggero leichtgewichtig
hecho en España made in Spain fabriqué en Espagne fatto in Spagna in Spanien hergestellt	fácil limpieza easy cleaning nettoyage facile facile pulizia leichte Reinigung	no absorbente non-absorbent non absorbant non assorbente nicht absorbierend
sifón accesible accessible siphon siphon accessible sifone accessibile zugänglicher Siphon	certificado certificate certifié certificato Zertifikat	bacteriostático bacteriostatic bactériostatique batteriostatico bakterienhemmend
masa pigmentada pigmented mass masse pigmentée massa colorata Pigmentmasse	fácil instalación easy installation installation facile facile installazione einfache Installation	antideslizante non-slip anti-dérapant antiscivolo rutschfest

COLORES Y ACABADOS / COLOURS AND FINISHES / COULEURS ET FINITIONS / COLORI E FINITURE / FARBEN UND AUSFÜHRUNGEN

RAL 9003	RAL 9001	RAL 7044	RAL 7037	RAL 9005				
RAL 7035	RAL 1013	RAL 1019	RAL 7015	RAL 8017	colores NCS NCS colours couleurs NCS colori NCS NCS Farben	colores RAL RAL colours couleurs RAL colori RAL RAL Farben	acabados TECH finishes finitions TECH finiture TECH	acabados DECO finishes finitions DECO finiture DECO

* extensión de garantía opcional / optional warranty extension / extension de garantie optionnelle / estensione de garanzia opzionale / optionale Garantieverlängerung



STRUCT

PLATO DE DUCHA
SHOWER TRAY
RECEVEUR DE DOUCHE
PIATTO DOCCIA
DUSCHWANNE

FABRICACIÓN A MEDIDA
CUSTOMIZED MANUFACTURE
FABRIQUE SUR MESURE
PRODUZIONE FATTA SU MISURA
FERTIGUNG NACH MAß



FABRICACIÓN A MEDIDA
CUSTOMIZED MANUFACTURE
FABRIQUE SUR MESURE
PRODUZIONE FATTA SU MISURA
FERTIGUNG NACH MAß

PLATO DE DUCHA
SHOWER TRAY
RECEVEUR DE DOUCHE
PIATTO DOCCIA
DUSCHWANNE

STRUCT



MEDIDAS ESTÁNDAR DISPONIBLES Y DISTANCIA A VÁLVULA
STANDARD MEASURES AVAILABLE AND DISTANCE TO VALVE / MESURES STANDARD DISPONIBLES ET DISTANCE À LA VANNE
MISURE STANDARD DISPONIBILI E DISTANZA DEL SIFONE / VERFÜGBARE STANDARDGRÖßEN UND ENTFERNUNG ZUM ABLAUF

	A																			C		
	80	90	100	110	120	130	140	150	160	170	180	190	200	210	220	230	240	250	260		270	280
70	40	40	40	40	40	40	40	40	40	40	40	40	50	50	*	*	*	*	*	*	*	*
75	40	40	40	40	40	40	40	40	40	40	40	40	50	50	*	*	*	*	*	*	*	*
80	40	40	40	40	40	40	40	40	40	40	40	40	50	50	*	*	*	*	*	*	*	*
90		45	40	40	40	40	40	40	40	40	40	40	50	50	*	*	*	*	*	*	*	*
100			*	*	*	*	*	*	*	*	*	*	*	*	*	*	*	*	*	*	*	*
110				*	*	*	*	*	*	*	*	*	*	*	*	*	*	*	*	*	*	*
120					*	*	*	*	*	*	*	*	*	*	*	*	*	*	*	*	*	*
130						*	*	*	*	*	*	*	*	*	*	*	*	*	*	*	*	*

* consultar distancia a válvula / consult distance to valve / consulter distance à la vanne / consultare distanza del sifone / Entfernung zum Ablauf abfragen

HOJA TÉCNICA / TECHNICAL DATA SHEET
FICHE TECHNIQUE / SCHEDE TECNICA / DATENBLATT

FABRICACIÓN A MEDIDA / CUSTOMIZED MANUFACTURE
FABRIQUE SUR MESURE / PRODUZIONE FATTA SU MISURA / FERTIGUNG NACH MAß

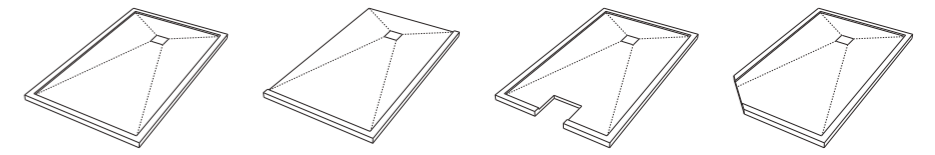

Diseño adaptable a medidas intermedias a las estándar o a cortes especiales para salvar esquinas, columnas y ángulos.
Adaptable design to intermediate measures to the standard ones or to special cuts to save the corners, columns and angles.
Design adaptable aux mesures intermédiaires aux coupes standard, ou coupes spéciales pour surmonter les coins, les colonnes et les angles.
Design adattabile alle misure intermedie a tagli standard o tagli speciali per riporre spigolo, colonne e angoli.
Anpassungsfähiges Design für Zwischenmessungen die von Standardmaßen abweichen oder Sonderschnitte, um Ecken, Säulen und Winkel zu berücksichtigen

STRUCT DETAIL
Plato enmarcado personalizable (1, 2, 3 y 4 marcos)
Shower tray with customizable frames (1, 2, 3 and 4 frames):
Receveur de douche avec encadrement personnalisable (1, 2, 3 et 4 cadres):
Piatto doccia con cornici personalizzabile (1, 2, 3 o 4 cornici):
Duschwanne mit personalisierbaren Rahmen (1, 2, 3 und 4 Rahmen):

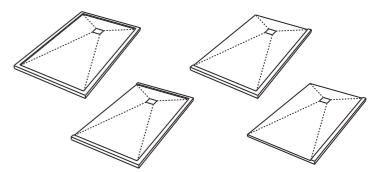

TEXTURA / TEXTURE
TEXTURE / FINITURA / TEXTUR

pizarra antideslizante non-slip slate
ardoise anti-dérapant
ardesia antiscivolo
rutschfest Schiefer
clase 2 o 3
class 2 or 3 / classe 2 ou 3
Klasse 2 oder 3

VÁLVULAS / VALVES
VANNES / SIFONI / ABLAUFVENTILE



REJILLAS / GRIDS
GRILLES / GRIGLIE / ABLAUFGITTER



estándar standard standard
lacada lacquered laquée
standard standard
laccata lackiert

Las rejillas están disponibles en todos los colores
Grids are available in all the colours
Les grilles sont disponibles dans toutes les couleurs
Le griglie sono disponibili in tutti i colori
Die Ablaufgitter sind in allen Farben verfügbar

PROPIEDADES / PROPERTIES / PROPRIÉTÉS / CARATTERISTICHE / EIGENSCHAFTEN

	garantía 3 años * 3 years guarantee * garantie 3 ans * garanzia 3 anni * 3 Jahre Garantie *		ecofriendly ecofriendly ecofriendly ecofriendly		ligero light weight léger leggero leichtgewichtig
	hecho en España made in Spain fabriqué en Espagne fatto in Spagna in Spanien hergestellt		fácil limpieza easy cleaning nettoyage facile facile pulizia leichte Reinigung		bacteriostático bacteriostatic bactériostatique batteriostatico bakterienhemmend
	sifón accesible accessible siphon siphon accessible sifone accessibile zugänglicher Siphon		certificado certificate certifié certificato Zertifikat		antideslizante non-slip anti-dérapant antiscivolo rutschfest
	masa pigmentada pigmented mass masse pigmentée massa colorata Pigmentmasse		fácil instalación easy installation installation facile facile installazione einfache Installation		no absorbente non-absorbent non absorbant non absorbente nicht absorbierend

COLORES Y ACABADOS / COLOURS AND FINISHES / COULEURS ET FINITIONS / COLORI E FINITURE / FARBEN UND AUSFÜHRUNGEN

colores NCS
NCS colours
couleurs NCS
colori NCS
NCS Farben

colores RAL
RAL colours
couleurs RAL
colori RAL
RAL Farben

* extensión de garantía opcional / optional warranty extension / extension de garantie optionnelle / estensione de garanzia opzionale / optionale Garantieverlängerung

PLATO DE DUCHA
SHOWER TRAY
RECEVEUR DE DOUCHE
PIATTO DOCCIA
DUSCHWANNE

FABRICACIÓN A MEDIDA
CUSTOMIZED MANUFACTURE
FABRIQUE SUR MESURE
PRODUZIONE FATTA SU MISURA
FERTIGUNG NACH MAß

CENTRAL

154



① CENTRAL

PLATO DE DUCHA
SHOWER TRAY
RECEVEUR DE DOUCHE
PIATTO DOCCIA
DUSCHWANNE

REJILLA: LACADA
GRID: LAQUERED
GRILLE: LAQUÉE
GRIGLIA: LACCATA
ABLAUGGITTER: LACKIERT

RAL: 9003

p. 154

② PANEL

PANEL DE REVESTIMIENTO
WALL PANEL
PANNEAU MURAL
PANNELLO DI REVESTIMENTO
VERKLEIDUNGSPLATTE

RAL: 9003

p. 164

③ CANNES

LAVABO
WASHBASIN
VASQUE
LAVABO
WASCHTISCH

RAL: 9005

p. 116

④ BERGAMO

ENCIMERA
COUNTERTOP BASIN
PLAN VASQUE
PIANO LAVABO
WASCHTISCH

TECH: GREY STONE

p. 76

155

CENTRAL

PLATO DE DUCHA
SHOWER TRAY
RECEVEUR DE DOUCHE
PIATTO DOCCIA
DUSCHWANNE

FABRICACIÓN A MEDIDA
CUSTOMIZED MANUFACTURE
FABRIQUE SUR MESURE
PRODUZIONE FATTA SU MISURA
FERTIGUNG NACH MAß

156



157



FABRICACIÓN A MEDIDA
CUSTOMIZED MANUFACTURE
FABRIQUE SUR MESURE
PRODUZIONE FATTA SU MISURA
FERTIGUNG NACH MAß

PLATO DE DUCHA
SHOWER TRAY
RECEVEUR DE DOUCHE
PIATTO DOCCIA
DUSCHWANNE

CENTRAL



MEDIDAS ESTÁNDAR DISPONIBLES Y DISTANCIA A VÁLVULA
STANDARD MEASURES AVAILABLE AND DISTANCE TO VALVE / MESURES STANDARD DISPONIBLES ET DISTANCE À LA VANNE
MISURE STANDARD DISPONIBILI E DISTANZA DEL SIFONE / VERFÜGBARE STANDARDGRÖßEN UND ENTFERNUNG ZUM ABLAUF

	A																C		
	70	80	90	100	110	120	130	140	150	160	170	180	190	200	210	220		230	240
70	35	40	45	50	55	60	65	70	75	80	85	90	95	100	105	110	115	120	125
80	35	40	45	50	55	60	65	70	75	80	85	90	95	100	105	110	115	120	125
90		40	45	50	55	60	65	70	75	80	85	90	95	100	105	110	115	120	125
100			45	50	55	60	65	70	75	80	85	90	95	100	105	110	115	120	125
110				50	55	60	65	70	75	80	85	90	95	100	105	110	115	120	125
120					55	60	65	70	75	80	85	90	95	100	105	110	115	120	125
130						60	65	70	75	80	85	90	95	100	105	110	115	120	125

HOJA TÉCNICA / TECHNICAL DATA SHEET
FICHE TECHNIQUE / SCHEDA TECNICA / DATENBLATT

FABRICACIÓN A MEDIDA / CUSTOMIZED MANUFACTURE
FABRIQUE SUR MESURE / PRODUZIONE FATTA SU MISURA / FERTIGUNG NACH MAß

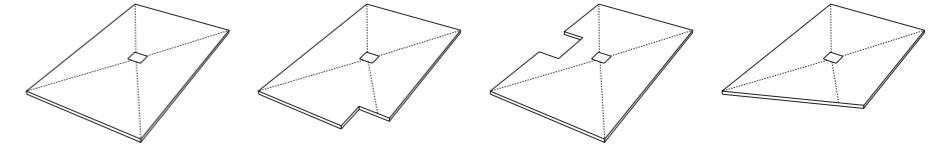

Diseño adaptable a medidas intermedias a las estándar o a cortes especiales para salvar esquinas, columnas y ángulos.
Adaptable design to intermediate measures to the standard ones or to special cuts to save the corners, columns and angles.

Design adaptable aux mesures intermédiaires aux coupes standard, ou coupes spéciales pour surmonter les coins, les colonnes et les angles.

Design adattabile alle misure intermedie a tagli standard o tagli speciali per riporre spigolo, colonna e angoli.
Anpassungsfähiges Design für Zwischenmessungen die von Standardmaßen abweichen oder Sonderschnitte, um Ecken, Säulen und Winkel zu berücksichtigen

TEXTURA / TEXTURE
TEXTURE / FINITURA / TEXTUR

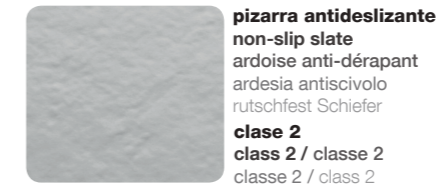

pizarra antideslizante
non-slip slate
ardoise anti-dérapant
ardesia antiscivolo
rutschfest Schiefer
clase 2
class 2 / classe 2
classe 2 / class 2

REJILLAS / GRIDS
GRILLES / GRIGLIE / ABLAUFGITTER



estándar
standard standard
lacada
lacquered laquée
laccata lackiert

VÁLVULAS / VALVES
VANNES / SIFONI / ABLAUFVENTILE



Las rejillas están disponibles en todos los colores
Grids are available in all the colours
Les grilles sont disponibles dans toutes les couleurs
Le griglie sono disponibili in tutti i colori
Die Ablaufgitter sind in allen Farben verfügbar

PROPIEDADES / PROPERTIES / PROPRIÉTÉS / CARATTERISTICHE / EIGENSCHAFTEN

garantía 3 años * 3 years guarantee * garantie 3 ans * garanzia 3 anni * 3 Jahre Garantie *	ecofriendly ecofriendly ecofriendly ecofriendly	ligero light weight léger leggero leichtgewichtig
hecho en España made in Spain fabriqué en Espagne fatto in Spagna in Spanien hergestellt	fácil limpieza easy cleaning nettoyage facile facile pulizia leichte Reinigung	no absorbente non-absorbent non absorbant non assorbente nicht absorbierend
sifón accesible accessible siphon siphon accessible sifone accessibile zugänglicher Siphon	certificado certificate certifié certificato Zertifikat	bacteriostático bacteriostatic bactériostatique batteriostatico bakterienhemmend
masa pigmentada pigmented mass masse pigmentée massa colorata Pigmentmasse	fácil instalación easy installation installation facile facile installazione einfache Installation	antideslizante non-slip anti-dérapant antiscivolo rutschfest

COLORES Y ACABADOS / COLOURS AND FINISHES / COULEURS ET FINITIONS / COLORI E FINITURE / FARBEN UND AUSFÜHRUNGEN

RAL 9003	RAL 9001	RAL 7044	RAL 7037	RAL 9005				
RAL 7035	RAL 1013	RAL 1019	RAL 7015	RAL 8017	colores NCS NCS colours couleurs NCS colori NCS NCS Farben	colores RAL RAL colours couleurs RAL colori RAL RAL Farben	acabados TECH TECH finishes finitions TECH finiture TECH	acabados DECO DECO finishes finitions DECO finiture DECO

* extensión de garantía opcional / optional warranty extension / extension de garantie optionnelle / estensione de garanzia opzionale / optionale Garantieverlängerung

RATIO

PLATO DE DUCHA
SHOWER TRAY
RECEVEUR DE DOUCHE
PIATTO DOCCIA
DUSCHWANNE

FABRICACIÓN A MEDIDA
CUSTOMIZED MANUFACTURE
FABRIQUE SUR MESURE
PRODUZIONE FATTA SU MISURA
FERTIGUNG NACH MAß



FABRICACIÓN A MEDIDA
CUSTOMIZED MANUFACTURE
FABRIQUE SUR MESURE
PRODUZIONE FATTA SU MISURA
FERTIGUNG NACH MAß

PLATO DE DUCHA
SHOWER TRAY
RECEVEUR DE DOUCHE
PIATTO DOCCIA
DUSCHWANNE

RATIO



MEDIDAS ESTÁNDAR DISPONIBLES Y DISTANCIA A VÁLVULA
STANDARD MEASURES AVAILABLE AND DISTANCE TO VALVE / MESURES STANDARD DISPONIBLES ET DISTANCE À LA VANNE
MISURE STANDARD DISPONIBILI E DISTANZA DEL SIFONE / VERFÜGBARE STANDARDGRÖßEN UND ENTFERNUNG ZUM ABLAUF

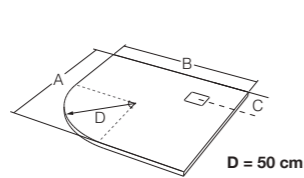

		A						
		70	75	80	90	100		
B	70	25						
	75		25					
	80			25				
	90				25			
	100					25		

HOJA TÉCNICA / TECHNICAL DATA SHEET
FICHE TECHNIQUE / SCHEDA TECNICA / DATENBLATT

FABRICACIÓN A MEDIDA / CUSTOMIZED MANUFACTURE
FABRIQUÉ SUR MESURE / PRODUZIONE FATTA SU MISURA / FERTIGUNG NACH MAß



Diseño adaptable a medidas intermedias a las estándar o a cortes especiales para salvar esquinas, columnas y ángulos.
Adaptable design to intermediate measures to the standard ones or to special cuts to save the corners, columns and angles.

Design adaptable aux mesures intermédiaires aux coupes standard, ou coupes spéciales pour surmonter les coins, les colonnes et les angles.

Design adattabile alle misure intermedie a tagli standard o tagli speciali per riporre spigolo, colonne e angoli.

Anpassungsfähiges Design für Zwischenmessungen die von Standardmaßen abweichen oder Sonderschnitte, um Ecken, Säulen und Winkel zu berücksichtigen

TEXTURA / TEXTURE
TEXTURE / FINITURA / TEXTUR

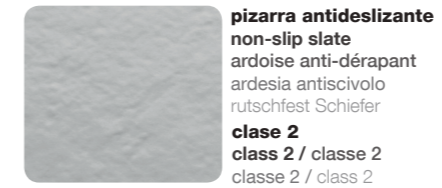

pizarra antideslizante
non-slip slate
ardoise anti-dérapant
ardesia antiscivolo
rutschfest Schiefer
clase 2
class 2 / classe 2
classe 2 / class 2

REJILLAS / GRIDS
GRILLES / GRIGLIE / ABLAUFGITTER



estándar
standard standard
standard standard

lacada
lacquered laquée
laccata lackiert

Las rejillas están disponibles en todos los colores
Grids are available in all the colours

Les grilles sont disponibles dans toutes les couleurs
Le griglie sono disponibili in tutti i colori

Die Ablaufgitter sind in allen Farben verfügbar

VÁLVULAS / VALVES
VANNES / SIFONI / ABLAUFVENTILE



PROPIEDADES / PROPERTIES / PROPRIÉTÉS / CARATTERISTICHE / EIGENSCHAFTEN



garantía 3 años *
3 years guarantee *
garantie 3 ans *
garanzia 3 anni *
3 Jahre Garantie *



ecofriendly
ecofriendly
ecofriendly
ecofriendly



ligero
light weight
léger
leggero
leichtgewichtig



hecho en España
made in Spain
fabriqué en Espagne
fatto in Spagna
in Spanien hergestellt



fácil limpieza
easy cleaning
nettoyage facile
facile pulizia
leichte Reinigung



no absorbente
non-absorbent
non absorbant
non absorbent
nicht absorbierend



sifón accesible
accessible siphon
siphon accessible
sifone accessibile
zugänglicher Siphon



certificado
certificade
certifié
certificato
Zertifikat



bacteriostático
bacteriostatic
bacteriostatique
batteriostatico
bakterienhemmend



masa pigmentada
pigmented mass
masse pigmentée
massa colorata
Pigmentmasse



fácil instalación
easy installation
installation facile
facile installazione
einfache Installation



antideslizante
non-slip
anti-dérapant
antiscivolo
rutschfest

COLORES Y ACABADOS / COLOURS AND FINISHES / COULEURS ET FINITIONS / COLORI E FINITURE / FARBEN UND AUSFÜHRUNGEN

	RAL 9003		RAL 9001		RAL 7044		RAL 7037		RAL 9005				
	RAL 7035		RAL 1013		RAL 1019		RAL 7015		RAL 8017	colores NCS NCS colours couleurs NCS colori NCS NCS Farben	colores RAL RAL colours couleurs RAL colori RAL RAL Farben	acabados TECH TECH finishes finitions TECH finiture TECH	acabados DECO DECO finishes finitions DECO finiture DECO

* extension de garantía opcional / optional warranty extension / extension de garantie optionnelle / estensione de garanzia opzionale / optionale Garantieverlängerung
** opcional / ** optional / ** optionnel / ** opzionale / ** optional



PANELES DE REVESTIMIENTO
WALL PANELS
PANNEAUX MURAUX
PANNELI DI REVESTIMENTO
VERKLEIDUNGSPLETTEN

PANELES

PANEL DE REVESTIMIENTO
WALL PANEL
PANNÉAU MURAL
PANNELLO DI REVESTIMENTO
VERKLEIDUNGSPLATTE

FABRICACIÓN A MEDIDA
CUSTOMIZED MANUFACTURE
FABRIQUE SUR MESURE
PRODUZIONE FATTA SU MISURA
FERTIGUNG NACH MAß



PANELES

PANEL DE REVESTIMIENTO
WALL PANEL
PANNÉAU MURAL
PANNELLO DI REVESTIMENTO
VERKLEIDUNGSPLATTE

FABRICACIÓN A MEDIDA
CUSTOMIZED MANUFACTURE
FABRIQUE SUR MESURE
PRODUZIONE FATTA SU MISURA
FERTIGUNG NACH MAß



MEDIDAS / MEASURES / MESURES
MISUR / ABMESSUNGEN

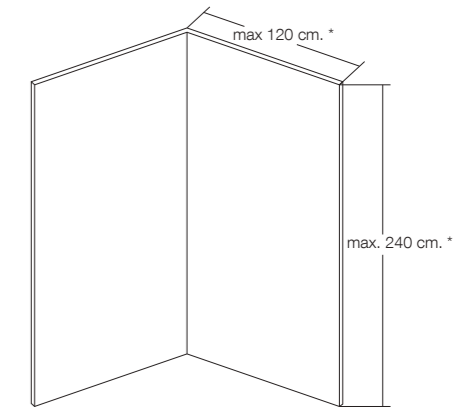

* Otras medidas consultar
For other dimensions please consult
Pour d'autres mesures, veuillez consulter
Per altre misure si prega di consultare
Für andere Abmessungen, bitte anfragen

OPCIONES / OPTIONS / OPTIONS
OPZIONI / OPTIONEN

TEXTURA / TEXTURE
TEXTURE / FINITURA / TEXTUR

lisa
smooth
lisse
liscia
glatt

cemento
cement
ciment
cemento
Zement

pizarra
slate
ardoise
ardesia
Schiefer

madera
wood
bois
legno
Holz

PROPIEDADES / PROPERTIES / PROPRIÉTÉS / CARATTERISTICHE / EIGENSCHAFTEN



garantía 3 años *
3 years guarantee *
garantie 3 ans *
garanzia 3 anni *
3 Jahre Garantie *



hecho en España
made in Spain
fabriqué en Espagne
fatto in Spagna
in Spanien hergestellt



fácil instalación
easy installation
installation facile
facile installazione
einfache Installation



ecofriendly
ecofriendly
ecofriendly
ecofriendly
ecofriendly



bacteriostático
bacteriostatic
bactériostatique
batteriostatico
bakterienhemmend



fácil limpieza
easy cleaning
nettoyage facile
facile pulizia
leichte Reinigung



ligero
light weight
léger
leggero
leichtgewichtig



grosor
thickness
épaisseur
spessore
Dicke



certificado
certificate
certifié
certificato
Zertifikat



masa pigmentada
pigmented mass
masse pigmentée
massa colorata
Pigmentmasse



no absorbente
non-absorbent
non absorbant
non assorbente
nicht absorbierend

COLORES Y ACABADOS / COLOURS AND FINISHES / COULEURS ET FINITIONS / COLORI E FINITURE / FARBEN UND AUSFÜHRUNGEN

 RAL 9003	 RAL 9001	 RAL 7044	 RAL 7037	 RAL 9005				
 RAL 7035	 RAL 1013	 RAL 1019	 RAL 7015	 RAL 8017	colores NCS NCS colours couleurs NCS colori NCS NCS Farben	colores RAL RAL colours couleurs RAL colori RAL RAL Farben	acabados TECH TECH finishes finitions TECH finiture TECH TECH Ausführungen	acabados DECO DECO finishes finitions DECO finiture DECO DECO Ausführungen

* extension de garantía opcional / * optional warranty extension / * extension de garantie optionnelle / * estensione de garanzia opzionale / * optionale Garantieverlängerung

PANELES

PANEL DE REVESTIMIENTO
WALL PANEL
PANNÉAU MURAL
PANNELLO DI REVESTIMENTO
VERKLEIDUNGSPLATTE

FABRICACIÓN A MEDIDA
CUSTOMIZED MANUFACTURE
FABRIQUE SUR MESURE
PRODUZIONE FATTA SU MISURA
FERTIGUNG NACH MAß



PANELES

PANEL DE REVESTIMIENTO
WALL PANEL
PANNÉAU MURAL
PANNELLO DI REVESTIMENTO
VERKLEIDUNGSPLATTE

FABRICACIÓN A MEDIDA
CUSTOMIZED MANUFACTURE
FABRIQUE SUR MESURE
PRODUZIONE FATTA SU MISURA
FERTIGUNG NACH MAß



CONDICIONES GENERALES

ES

PEDIDOS:

Todos los pedidos deben ser siempre remitidos por escrito a nuestro departamento comercial a través del correo electrónico (ventas@aqgbathrooms.com) con el fin de evitar cualquier tipo de error o malentendido.

MODIFICACIONES O ANULACIONES DE PEDIDOS:

No se admitirán anulaciones o modificaciones en los pedidos de artículos a medida ni de colores especiales una vez hayan entrado en producción. Para saber si el pedido está en proceso de producción el cliente deberá ponerse en contacto con nuestro departamento comercial por correo electrónico.

PRECIOS:

Los precios de nuestra tarifa se consideran precios recomendados de venta al público antes de impuestos. Los precios de venta aplicados en factura serán aquellos de la tarifa vigente en el momento de la recepción del pedido. Estos precios pueden estar sujetos a cambios por motivos de diversa consideración, en cuyo caso se notificará oportunamente.

PLAZOS DE ENTREGA:

Nuestros plazos de entrega son aproximados y no podrán ser objeto de ninguna reclamación, a no ser que exista un pacto contrario.

DEVOLUCIÓN DE MERCANCÍA:

La empresa no aceptará ninguna devolución de mercancía sin previa autorización por parte de nuestro departamento comercial. En caso de devolución de una mercancía ésta deberá ser devuelta en su embalaje original. No se atenderán devoluciones de colores especiales ni de artículos a medida.

CONDICIONES DE PAGO:

Las facturas serán pagadas en los plazos establecidos por la Ley 15/2010, de 5 de julio, de modificación de la Ley 3/2004, de 29 de diciembre, por la que se establecen las medidas de lucha contra la morosidad en operaciones comerciales.

EMBALAJE Y TRANSPORTE:

Los productos son entregados debidamente embalados, adecuados y resistentes para su transporte. El cliente deberá informar en un plazo máximo de 24 horas en el caso de recibir material con daños tanto en los artículos como en el embalaje de los mismos a causa del transporte. Se deberá enviar comunicación escrita debidamente documentada, con el material gráfico oportuno tanto a fábrica como a la agencia de transporte.

En el caso de que el cliente no comunique la reclamación dentro del plazo de 24h., la empresa no se podrá hacer cargo de ninguna reclamación, ya que el transportista marca este plazo máximo de 24 horas para la comunicación de incidencias.

GARANTÍA:

AQG Bathrooms garantiza todos sus productos ante eventuales defectos imputables al proceso de fabricación durante un período de 3 años.

Para ejercer los derechos que ofrece esta garantía será imprescindible por parte del cliente, la presentación del comprobante de compra emitido al usuario final en la fecha de venta del producto.

Es **MUY IMPORTANTE** antes de la instalación del producto: cerciorarse que el color, el tamaño, la medida, la textura y el modelo son correctos, verificar que desagua correctamente en los productos que corresponda y comprobar que no existe ningún tipo de anomalía ni daño ya que no se aceptan reclamaciones sobre el producto una vez instalado.

Nuestra responsabilidad se limitará única y exclusivamente a sustituir el producto defectuoso y en ningún caso cubre gastos adicionales (gastos ocasionados por los trabajos de reparación, instalación, ...), los cuales correrán a cargo del consumidor.

EXCLUIDO DE LA GARANTÍA:

Los daños causados en la superficie por la utilización de productos de limpieza indebidos, la dureza del agua o por el desgaste natural del producto, así como los provocados como consecuencia de golpes e impactos no están cubiertos por la garantía.

La garantía dejará de tener validez por un almacenamiento inadecuado, una instalación incorrecta y las negligencias en la manipulación de cualquier artículo.

Quedan excluidos de esta garantía los defectos provocados por un uso y mantenimiento negligentes o inadecuados del artículo.

COLORES:

Pueden darse sutiles diferencias entre las imágenes de los productos, las muestras de acabados y el producto entregado en cuanto a la tonalidad de los colores y el aspecto se refiere. Estas diferencias no podrán ser nunca motivo de reclamación.

DIMENSIÓN: (tolerancia dimensional)

Debido a la contracción que experimenta nuestra masa en el proceso de secado nuestros productos pueden tener una variación del 0,7% respecto a las dimensiones solicitadas.

PRODUCTOS:

Nuestros productos podrán ser modificados total o parcialmente, sin previo aviso, en beneficio del artículo. La documentación de este catálogo, fotografías, descripciones y esquemas técnicos, tienen un valor indicativo, por lo que el cliente no se podrá acoger a ellos en caso de disconformidad con el producto suministrado.

ACEPTACIÓN DE CONDICIONES:

Todo pedido recibido, implica la aceptación de estas condiciones, salvo en el caso de que se hayan pactado otras por escrito.

PROPIEDAD INTELECTUAL:

Todas las imágenes e ilustraciones contenidas en este catálogo son propiedad de AQGBathrooms o de sus respectivos propietarios. No se permite el uso de las mismas a terceras personas sin la autorización expresa de nuestra empresa o de los respectivos propietarios de los contenidos.

GENERAL CONDITIONS

EN

ORDERS:

All the orders must be sent by written to our sales department through email (ventas@aqgbathrooms.com) in order to avoid mistakes and misunderstandings.

AMENDMENTS OR CANCELLATION OF ORDERS:

Amendments or cancellations will not be accepted in orders which contain customized measures or special colours once they are already in the production process. In order to know if the order is already in the production process the client must contact our sales department by email.

PRICES:

The prices of our price list are retail prices before taxes. The retail prices applied in the invoice will be those that appear in the current price list in the moment of the reception of the order. These prices may be subject to changes because of diverse nature and in which case will be duly notified.

DELIVERY TIME:

Our delivery times are approximate and will not be subject to any claim unless exists any other agreement between parties.

RETURN OF GOODS:

The company will not accept any return of merchandise without previous authorization by our sales department. In case of return of merchandise, this, must be returned with its original package.

PACKAGING AND TRANSPORT:

The products are delivered properly packed and in an appropriate and resistant way for its transport. The client will have to inform within 24 hours in case of receiving damaged merchandise in both cases; damage in the packaging or in the product because of the transport. It will be necessary to send a written communication properly documented with graphical material to factory as well as to the transport agency.

In case the client does not communicate such claim within 24 hours the company will not be in charge of any claim due to the fact that this is the maximum period established by the transport agency for communicating incidents.

WARRANTY:

AQG Bathrooms guarantees all their products against possible defects which are attributable to the production process during a period of 3 years.

To exercise the right that offers this guarantee is necessary that the client presents the purchase receipt issued to the end user with the date which the product was bought. It is **VERY IMPORTANT** before the installation of the product to make sure that the colour, size, measures, texture and model are correct, verify that drains correctly in the corresponding products and verify also that does not exist any type of anomaly nor damage because claims of products already installed will not be accepted.

Our liability will be limited only and exclusively to substitute the defective product and in no case will cover additional expenses (costs related to repair works, installation, etc.), which will be in charge of the consumer.

WARRANTY EXCLUSION:

The damages caused in the surface because of using inappropriate cleaning products, hardness of water or because of the natural wear of the product, as well as those caused by consequences of strokes and impacts are not covered by the warranty. The warranty will not be longer valid because of an inappropriate storage, incorrect installation or negligence in the manipulation of any product.

Will be excluded of this warranty also the defects caused because of a bad use or inadequate maintenance.

COLOURS:

Slight differences in colour can occur between the pictures and the products, the samples of finishings and the product delivered in terms of tonality and aspect. These differences will never be reason of claim.

DIMENSIONS: (dimensional tolerance)

Because of the contraction that experiences our mass in the drying process, our products may have a variation of 0.7% respect the dimensions required.

DESIGNS:

Our products may be modified completely or partially without previous notification in benefit of the product. The documentation of this catalogue, pictures, descriptions and technical drawings have an indicative value, therefore, the client will not be able to take them into account in case of disconformity with the product supplied.

ACCEPTANCE OF CONDITIONS:

All orders received means the acceptance of these conditions, unless something else has been accorded by written.

INTELLECTUAL PROPERTY:

All the pictures and illustrations contained in this catalogue are property of AQG Bathrooms or of their respective owners. It is not allowed its use to third parties without the express authorization of our company or of the respective owners of the contents.

CONDITIONS GÉNÉRALES

FR

COMMANDES :

Toutes les commandes doivent toujours être envoyées par écrit à notre service commercial par courrier électronique (ventas@aqgbathrooms.com) afin d'éviter tout type d'erreur ou de malentendu.

Modifications ou annulations de commandes :

Les annulations ou modifications dans les commandes d'articles à mesure ou de couleurs spéciales ne seront pas acceptées une fois qu'ils sont entrés en production. Pour savoir si la commande est en cours de production, le client doit contacter notre service commercial par courrier électronique.

LES PRIX:

Les prix de notre tarif sont considérés comme des prix de vente conseillés avant taxes. Les prix de vente appliqués sur la facture seront ceux du tarif en vigueur au moment de la réception de la commande.

Ces prix peuvent être sujets à changement pour des raisons de considération différente, auquel cas vous serez informé au temps voulu.

DÉLAIS DE LIVRAISON:

Nos délais de livraison sont approximatifs et ne peuvent faire l'objet d'aucune réclamation, sauf convention contraire.

RETOUR DE LA MARCHANDISE:

La société n'acceptera aucun retour de marchandise sans l'autorisation préalable de notre service commercial. En cas de retour de la marchandise, celle-ci doit être retournée dans son emballage d'origine. Les retours de couleurs spéciales ou d'articles à mesure ne seront pas acceptés.

EMBALLAGE ET TRANSPORT:

Les produits sont livrés correctement emballés, adéquats et résistants au transport.

Le client doit informer dans un délai maximum de 24 heures en cas de réception de matériel endommagé à la fois dans les articles et dans l'emballage des mêmes en raison du transport.

Il faudra envoyer une communication écrite dûment documentée, avec le matériel graphique approprié, à la fois à l'usine et à l'agence de transport.

Au cas où le client ne signalerait pas la réclamation dans les 24 heures, la société ne saurait être tenue pour responsable de toute réclamation, car le transporteur marquant ce délai maximum de 24 heures pour la communication des incidents.

GARANTIE:

AQG Bathrooms garantit tous ses produits contre les éventuels défauts imputables au processus de fabrication pendant une période de 3 ans.

Afin d'exercer les droits offerts par cette garantie, il sera essentiel que le client présente le reçu d'achat à l'utilisateur final à la date de vente du produit.

C'est très IMPORTANT avant l'installation du produit : assurez-vous que la couleur, la taille, la mesure, la texture et le modèle sont corrects, vérifiez qu'il se draine correctement dans les produits correspondants et vérifiez qu'il n'y a pas de type d'anomalie ou de dommage, car aucune revendication n'est acceptée sur le produit une fois installé.

Notre responsabilité se limitera uniquement et exclusivement à remplacer le produit défectueux et ne couvre en aucun cas des frais supplémentaires (frais occasionnés par des travaux de réparation, d'installation, ...), qui seront à la charge du consommateur.

EXCLUS DE LA GARANTIE:

Les dommages causés à la surface par l'utilisation de produits de nettoyage inappropriés, la dureté de l'eau ou par l'usure naturelle du produit, ainsi que ceux causés par les chocs et les impacts ne sont pas couverts par la garantie.

La garantie ne sera plus valable en raison d'un stockage inapproprié, d'une installation incorrecte et de la négligence dans la manipulation de tout article.

Les défauts résultant d'une utilisation ou d'une maintenance négligente ou inadéquate de l'article sont exclus de cette garantie.

COULEURS:

Il peut exister des différences subtiles entre les images des produits, les échantillons de finitions et le produit livré en termes de tonalité des couleurs et d'apparence. Ces différences ne peuvent jamais être un motif de plainte.

DIMENSION: (tolérance dimensionnelle)

En raison de la contraction de notre masse dans le processus de séchage, nos produits peuvent varier de 0,7% par rapport aux dimensions demandées.

PRODUITS:

Nos produits peuvent être modifiés totalement ou partiellement, sans préavis, au profit de l'article. La documentation de ce catalogue, les photographies, les descriptions et les schémas techniques ont une valeur indicative, de sorte que le client ne pourra pas s'abriter à ceux en cas de désaccord avec le produit fourni.

Acceptation de conditions :

Toute demande reçue implique l'acceptation de ces conditions, sauf si d'autres ont été convenues par écrit.

PROPRIÉTÉ INTELLECTUELLE:

Toutes les images et illustrations contenues dans ce catalogue sont la propriété d'AQG Bathrooms ou de leurs propriétaires respectifs. L'utilisation de la même chose à des tiers n'est pas autorisée sans l'autorisation expresse de notre société ou des propriétaires respectifs du contenu.

CONDIZIONI GENERALI

IT

ORDINI:

Tutti gli ordini devono sempre essere inviati per iscritto al nostro ufficio commerciale via e-mail (ventas@aqgbathrooms.com) al fine di evitare qualsiasi tipo di errore o incomprensione.

MODIFICHE O CANCELLAZIONI DI ORDINI:

Non si accetteranno cancellazioni o modifiche in ordini di articoli personalizzati o con colori speciali una volta questi siano già entrati in produzione. Per sapere se l'ordine è in fase di produzione, il cliente deve contattare il nostro ufficio commerciale via email.

PREZZI:

I prezzi del nostro catalogo sono considerati prezzi netti di tasse raccomandati per clienti al dettaglio. I prezzi di vendita applicati in fattura saranno quelli del valore corrente al momento della ricezione dell'ordine.

Questi prezzi possono essere soggetti a modifiche per motivi di diversa considerazione, nel qual caso si avviserà tempestivamente.

TEMPI DI CONSEGNA:

I nostri tempi di consegna sono approssimativi e non possono essere oggetto di reclami, a meno che non vi sia un accordo a riguardo.

RITORNO MERCE:

La società non accetterà alcuna restituzione di merce senza previa autorizzazione da parte del nostro reparto commerciale. In caso di restituzione di una merce essa deve essere restituita nella sua confezione originale. Non si accettano restituzioni di colori speciali o articoli su misura.

IMBALLAGGIO E TRASPORTO:

I prodotti vengono consegnati correttamente, imballati adeguatamente e resistenti al trasporto.

Il cliente dovrà informare entro massimo 24 ore in caso di ricevere materiale con danni di trasporto sia negli articoli che nella confezione degli stessi. Si dovrà comunicare direttamente e per iscritto alla fabbrica e all'agenzia di trasporti allegando la documentazione grafica opportuna.

Nel caso in cui il cliente non reclami entro 24 ore, la compagnia non sarà più responsabile della restituzione, dal momento che il corriere segna come periodo massimo 24 ore per la comunicazione di incidenti.

GARANZIA:

AQG Bathrooms garantisce tutti i suoi prodotti contro eventuali difetti imputabili al processo di fabbricazione durante un periodo di 3 anni.

Al fine di poter sfruttare questa garanzia, sarà essenziale per il cliente presentare la ricevuta di acquisto rilasciata all'utente finale nella data di vendita del prodotto.

È MOLTO IMPORTANTE prima di installare il prodotto: assicurarsi che il colore, le dimensioni, la misura, la finitura e il modello siano corretti, verificare che scarichi correttamente nei prodotti in questione e controllare che non vi sia alcuna anomalia o danno dato che non si accettano reclami sul prodotto già installato.

La nostra responsabilità sarà limitata unicamente ed esclusivamente a sostituire il prodotto difettoso e in nessun caso coprirà spese aggiuntive (spese causate da lavori di riparazione, installazione, ...), che saranno a carico del consumatore.

ESCLUSO DALLA GARANZIA:

I danni causati sulla superficie dell'articolo dati dall'utilizzo improprio di prodotti per la pulizia, durezza dell'acqua o usura del prodotto, così come quelli causati a seguito di urti e impatti non sono coperti dalla garanzia.

La garanzia non sarà più valida in caso di magazzinaggio inadeguato, installazione errata e negligenza nel trattamento di qualsiasi articolo.

Difetti causati da uso negligente o manutenzione inadeguata dell'articolo sono esclusi da questa garanzia.

COLORI:

Ci possono essere sottili differenze tra le immagini dei prodotti, i campioni di finiture e il prodotto consegnato in termini di tonalità dei colori e dell'aspetto. Queste differenze non potranno essere motivo di lamentela.

DIMENSIONE: (tolleranza dimensionale)

A causa della possibile contrazione della massa durante il processo di asciugatura, i nostri prodotti possono avere una variazione dello 0,7% rispetto alle dimensioni richieste.

PRODOTTI:

I nostri prodotti possono essere modificati totalmente o parzialmente, senza preavviso, a beneficio dell'articolo. La documentazione di questo catalogo, le fotografie, le descrizioni e le schede tecniche hanno valore indicativo, di conseguenza il cliente non potrà far riferimento e essi in caso di disaccordo con il prodotto fornito.

ACCETTAZIONE DELLE CONDIZIONI:

Qualsiasi richiesta ricevuta implica l'accettazione di queste condizioni, tranne nel caso in cui altre siano state accettate per iscritto.

PROPRIETÀ INTELLETTUALE:

Tutte le immagini e le illustrazioni contenute in questo catalogo sono di proprietà di AQG Bathrooms o dei rispettivi proprietari. L'uso delle stesse a terzi non è consentito senza l'espressa autorizzazione della nostra azienda o dei rispettivi proprietari dei contenuti.

ALLGEMEINE BEDINGUNGEN:

DE

AUFTRÄGE:

Alle Aufträge müssen stets schriftlich an unsere Verkaufsabteilung per E-Mail (ventas@aqgbathrooms.com) geschickt werden, um Fehler oder Missverständnisse zu vermeiden.

ÄNDERUNGEN ODER STORNIERUNGEN VON AUFTRÄGEN:

Stornierungen oder Änderungen bei den Bestellungen von maßgeschneiderten Artikeln oder Sonderfarben werden nach deren Produktionseingang nicht akzeptiert. Um herauszufinden, ob die Bestellung bereits produziert wird, muss sich der Kunde per E-Mail an unsere Vertriebsabteilung wenden.

PREISE:

Die Preise in unserer Preistafel gelten als empfehlende Vor-Steuer Endverbraucherpreise. Die auf der Rechnung angewendeten Verkaufspreise entsprechen der gültigen Preistafel zum Zeitpunkt des Auftrageingangs. Diese Preise können Änderungen durch unterschiedlichen Gründen unterliegen, in diesem Fall würden sie rechtzeitig mitgeteilt werden.

LIEFERTERMINE:

Unsere Liefertermine sind annähernd und können nicht Gegenstand von Beschwerde sein, es sei denn, es besteht ein andere Vereinbarung.

RÜCKSENDUNG DER WARE:

Das Unternehmen akzeptiert keine Rücksendung von Waren ohne vorherige Genehmigung durch unsere Verkaufsabteilung. Im Falle der Rücksendung einer Ware ist sie in der Originalverpackung zurückzugeben. Sonderfarben oder maßgeschneiderte Artikel können nicht zurückgegeben werden.

VERPACKUNG UND TRANSPORT:

Die Produkte werden ordnungsgemäß und angemessen verpackt und transportbeständig geliefert. Der Kunde hat bei Erhalt vom Material mit Schäden, sowohl an den Gegenständen als auch an der Verpackung, innerhalb von maximal 24 Stunden zu informieren. Eine ordnungsgemäß dokumentierte schriftliche Mitteilung ist mit dem zeckmäßigen Bildmaterial sowohl an die Fabrik als auch an die Transportagentur zu senden.

Für den Fall, dass der Kunde den Anspruch nicht innerhalb von 24 Stunden mitteilt, kann das Unternehmen keinen Anspruch annehmen, da die Transportagentur diese maximale Frist von 24 Stunden für die Meldung von Vorfällen festlegt.

GEWÄHRLEISTUNG:

AQG Bathrooms garantiert alle seine Produkte für einen Zeitraum von 3 Jahren gegen mögliche Mängel, die dem Herstellungsprozess zuzurechnen sind. Zur Ausübung der Rechte die diese Garantie anbietet, ist es erforderlich dass der Kunde den Kaufbeleg des Endverbrauchers mit Verkaufsdatum des Produkts vorlegt. Unsere Haftung beschränkt sich ausschließlich auf den Ersatz des mangelhaften Produkts und deckt in keinem Fall zusätzliche Kosten (Aufwendungen für Reparaturen, Installation, ...), die vom Verbraucher zu tragen sind.

AUSGENOMMEN VON DER GARANTIE:

Schäden an der Oberfläche die durch ungeeignete Reinigungsmittel, die Härte des Wassers oder den natürlichen Verschleiß des Produkts sowie solche, die durch Stöße und Aufprallen verursacht werden, fallen nicht unter die Garantie. Die Garantie verliert Ihre Gültigkeit durch eine ungeeignete Lagerung, eine unangemessene Installation und Nachlässigkeit bei der Handhabung des Produktes. Mängel, die durch eine fahrlässige oder unangemessene Nutzung und Wartung des Artikels verursacht wurden, sind von dieser Garantie ausgeschlossen.

FARBEN:

Es kann zu feinen Unterschieden zwischen Produktbildern, Fertigmustern und geliefertem Produkt in Bezug auf Farbton und Aussehen kommen. Diese Unterschiede können nie Anlass zur Beanstandung sein.

MASSE: (Maßtoleranz)

Aufgrund des Zusammenziehens unserer Masse im Trocknungsprozess können unsere Produkte eine Veränderung von 0,7% gegenüber den gewünschten Abmessungen aufweisen.

PRODUKTE:

Unsere Produkte können ganz oder teilweise, ohne vorherige Ankündigung, zugunsten des Artikels modifiziert werden. Die Dokumentation dieses Katalogs, Fotografien, Beschreibungen und technische Zeichnungen haben einen Richtwert, so dass der Kunde kein Anspruchsrecht über sie erheben kann, falls er mit dem gelieferten Produkt nicht zufrieden ist.

ANNAHME DER BEDINGUNGEN:

Jeder aufgenommene Auftrag bedeutet die Annahme dieser Bedingungen, es sei denn, es wurden andere Punkte schriftlich vereinbart.

GEISTIGES EIGENTUM:

Alle in diesem Katalog enthaltenen Bilder und Abbildungen sind Eigentum von AQGBathrooms oder deren jeweiligen Eigentümern. Die Nutzung dieser durch Dritte ist ohne ausdrückliche Genehmigung unseres Unternehmens oder der jeweiligen Inhaltseigentümer nicht gestattet.

