



NEXT GENERATION FOR STRONG FLOORS
ECO-PAVIMENTOS DE COMPOSITE MINERAL
DE ALTA CALIDAD



MATERIASPC
ECO-FLOORING STONE POLYMER CORE

EVOLUTION
TO EXCELLENCE

EVOLUCIÓN
HACIA LA EXCELENCIA

A perspective view of a floor panel with the MATERIASPC logo and text printed on it.

MATERIASPC
ECO-FLOORING STONE POLYMER CORE





INDEX

ÍNDICE

Internal structure -	6	- Estructura interna
Our quality -	8	- Nuestra calidad
Technical advantages / Warranty -	10	- Ventajas técnicas / Garantía
Vinyl flooring comparison -	12	- Comparativa suelos vinílicos
Placement -	14	- Colocación
Logistics / Replacement Service -	16	- Logística / Servicio de reposición
Products «à la carte» -	18	- Productos «a la carta»
MATERIASPC PRODUCTS		
Sapin -	20	- Sapin
Noyer -	30	- Noyer
Arancio -	36	- Arancio
Betulla -	44	- Betulla
Carrubo -	52	- Carrubo
Leccio -	58	- Leccio
Palatina -	66	- Palatina
Madox -	68	- Madox
SPECIAL PARTS / APPLIANCES		
Coordinated steps, skirtings & profiles -	70	- Peldaños, rodapiés y perfiles coordinados
TECHNICAL INFORMATION		
Test and certificates -	72	- Test y certificados
Packing list and displays -	74	- Embalajes y expositores
CONSUMER INFORMATION		
Removable -	76	- Desmontable
No CO ₂ footprint and recyclable -	78	- Sin huella de CO ₂ y reciclable

What are SPC flooring?

They are a new flooring generation, much more technologically advanced than its vinyl predecessors.

The acronym SPC stands for **Solid Polymer Composite**.

It is a material composed of a set of elements, **mainly minerals and PVC**, resulting in a product with unique characteristics:

Great resistance to wear, totally waterproof, non-deformable, very thermally stable, extreme hardness and very light.

Son una nueva generación de pavimentos, mucho mas avanzados tecnológicamente que sus predecesores vinílicos.

Las siglas SPC significan **Solid Polymer Composite**.
(Compuesto Polimérico Solido)

Es un material compuesto por un conjunto de elementos, **principalmente minerales y PVC**, obteniendo como resultado un producto con unas características singulares: gran resistencia al desgaste, totalmente impermeable, indeformable, muy estable térmicamente, dureza extrema y muy, muy ligero, entre otras.

¿Qué son los pavimentos SPC?



The first European company in producing SPC in Spain

La primera empresa europea en producir SPC en España

By EAST COAST SPC, S.A.

State-of-the-art technology that guarantees prompt service and quality products

Manufacturing cutting-edge products requires state-of-the-art machinery

We have invested in the latest technology to guarantee the highest product quality and prompt delivery, sustainability, optimization and resource recycling (0% waste) as well as the use of clean energy (about 80% derived from solar energy) throughout the production cycle.

Tecnología de última generación que garantiza agilidad en el servicio y calidad en el producto

La fabricación de productos de vanguardia requiere maquinaria de vanguardia

Hemos dotado a nuestras instalaciones con los últimos avances tecnológicos que garantizan la más alta calidad de nuestros productos y la rapidez en la entrega de los pedidos, la sostenibilidad, la optimización y el reciclado de los recursos (0% deshechos) así como el empleo de energía limpia (un 80% procedente de autoconsumo solar) en todo el proceso.

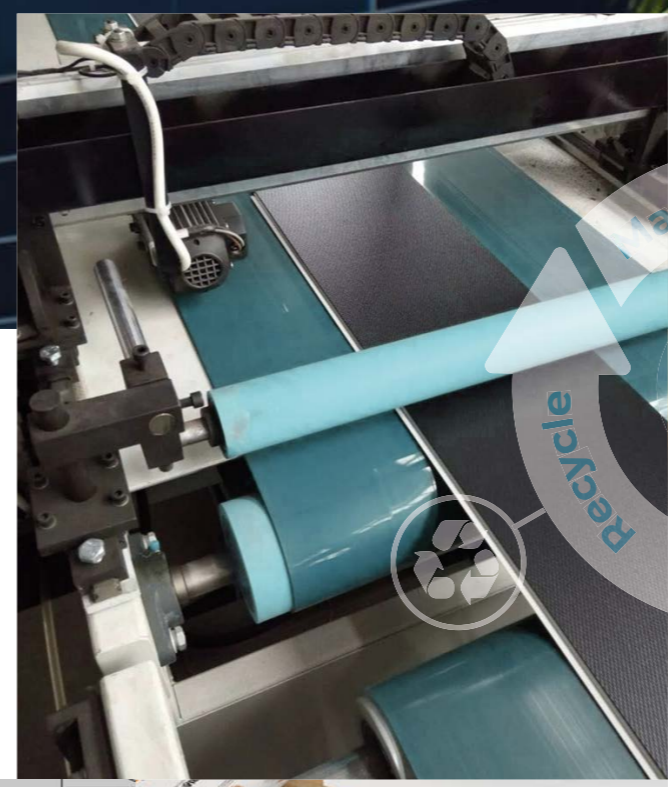

The first SPC manufacturing plant to work with renewable energy, thus helping to keep a clean environment.

La primera planta productora de SPC que trabaja con energías renovables, ayudando así a mantener limpio el medio ambiente.

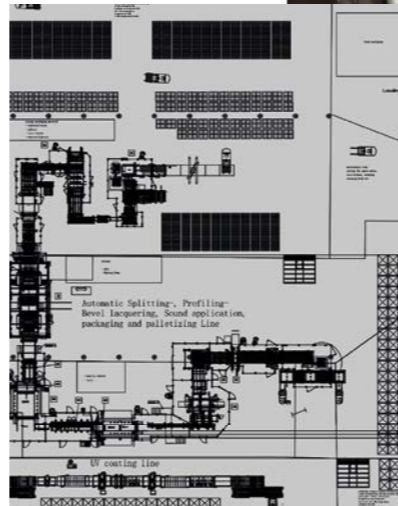

Evolution to excellence
La evolución hacia la excelencia

MATERIA SPC

ECO-FLOORING STONE POLYMER CORE

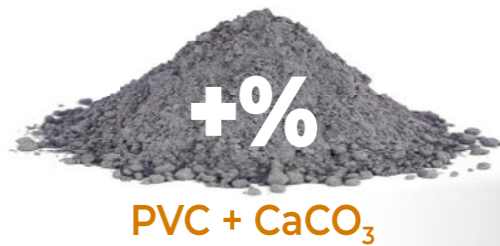

Higher percentage of PVC and calcium carbonate makes the difference

Mayor porcentaje de PVC y carbonato cálcico marcan la diferencia

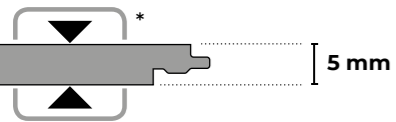
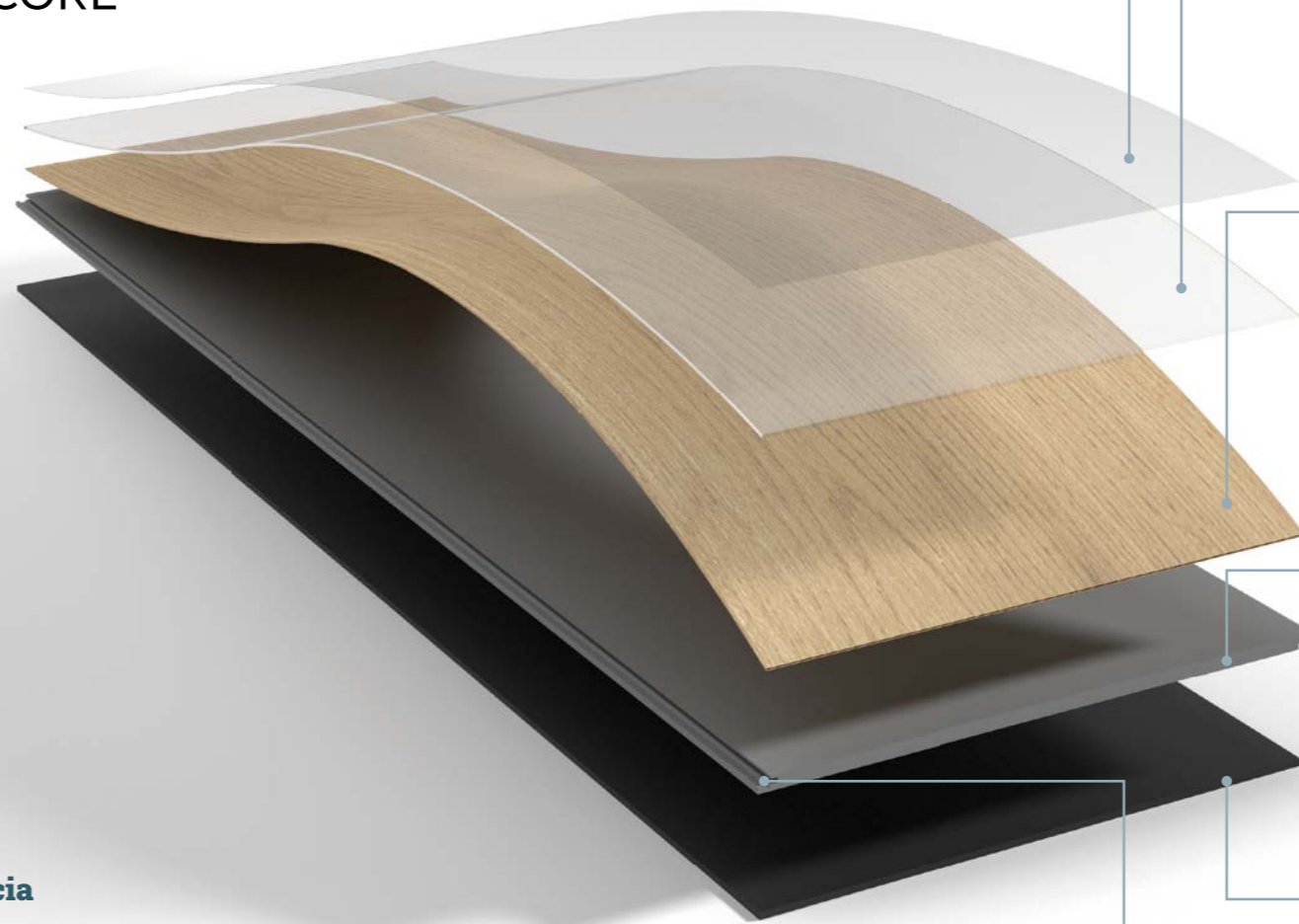

5 mm thick that concentrate technological efficiency

The arrangement of the materials and the formula used in its manufacture achieve **a product with properties much superior** to those of each of its components separately, resulting in a composite material with characteristics of impermeability, rigidity, resistance, lightness, comfort, thermostability, hardness and soundproofing **that are difficult to beat with other flooring.**

* 5.5 mm in larger sizes.
5,5 mm en formatos grandes.

5 mm de espesor que concentran eficiencia tecnológica

La disposición de los materiales y la fórmula empleada en su fabricación da como resultado **un producto con unas propiedades muy superiores** a las de cada uno de sus componentes por separado, dando como resultado un material compuesto con características de impermeabilidad, rigidez, resistencia, ligereza, confort, termoestabilidad, dureza e insonorización **difícilmente superables por otros pavimentos.**

Destined to endure

Destinados a perdurar



UV protection layer
Provides extra durability and protects colors.
Capa de protección contra rayos UV
Proporciona durabilidad extra y protege los colores.



Protective wear layer
Protective wear layer prevents excessive wear, gives scratch resistance and provides superior protection against stains and bumps.

Capa protectora de desgaste
Previene el desgaste excesivo, aporta resistencia al rayado y proporciona una protección superior contra las manchas y los golpes.



High definition decorative layer
Realistic designs are printed in high resolution, creating a unique natural style.

Capa decorativa de alta definición
Los diseños realistas se imprimen en alta resolución, creando un estilo natural único.



Lime stone composite core
Exclusive rigid core. 100% waterproof, prevents expansion and contraction.

Núcleo compuesto de carbonato cálcico
Núcleo rígido exclusivo. 100% impermeable, previene la expansión y contracción.



EVA underlayment for acoustic isolation
Insulates acoustically, fixes the product on the surface and absorbs imperfections from the subfloor.
Adhesive-free installation, directly on the ground.

Manto de aislamiento acústico EVA
Aísla acústicamente, fija el producto sobre la superficie y absorbe las imperfecciones del subsuelo.
Instalación sin adhesivos, directamente sobre el suelo.



Click Installation
Easy, clean and effortless assembly.

Instalación con Click
Montaje fácil, limpio y sin esfuerzo.

A new flooring generation is here
Una nueva generación de pavimentos está aquí

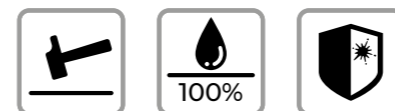
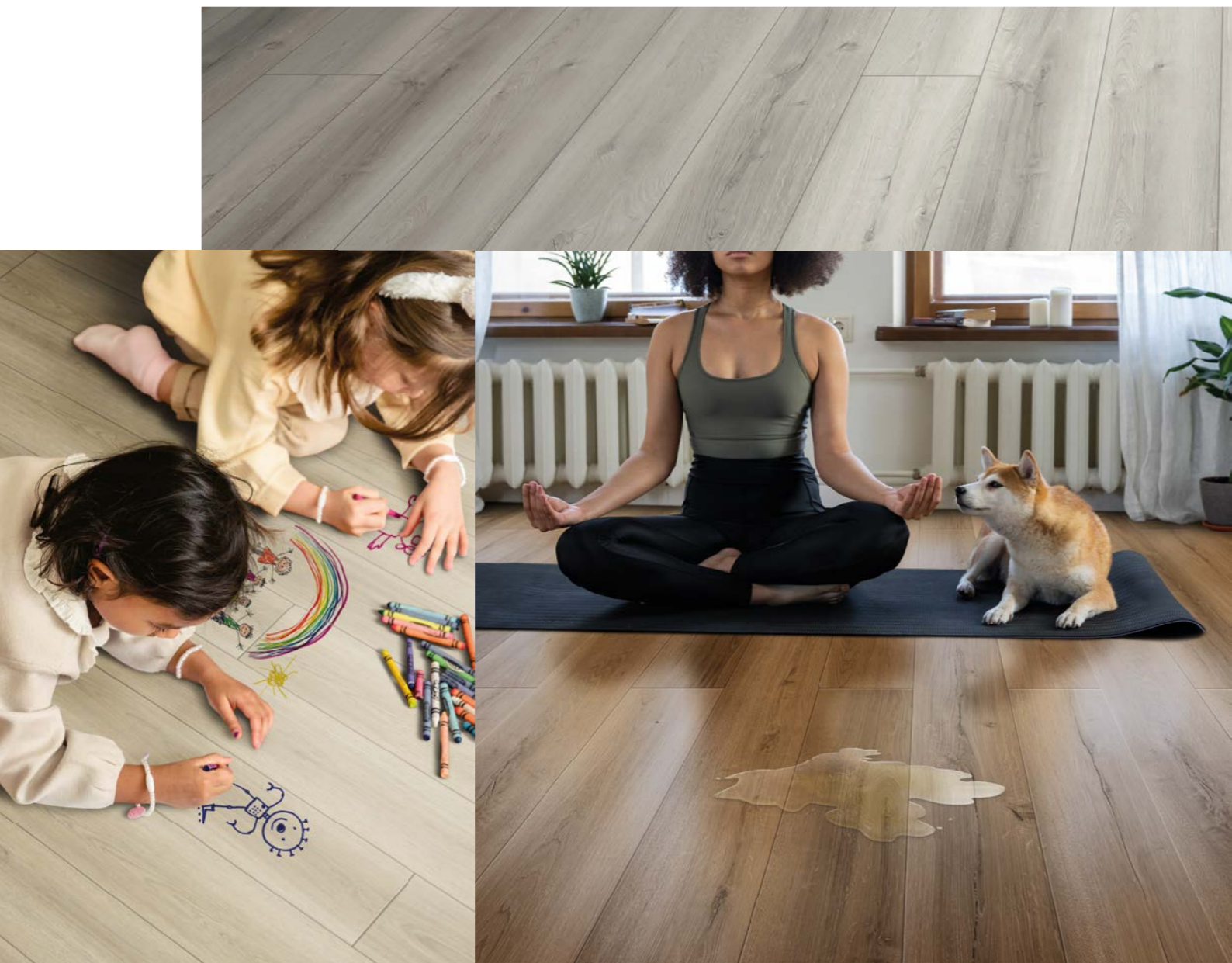

Quality for the most demanding ones
Calidad para los más exigentes

**Innovation,
comfort, design and economy**

A product that has it all.

The incessant search for solutions that improve what is known, the research and development of new, more efficient and sustainable compounds, the application of the latest technologies and the monitoring of design trends, drive us to offer innovative, technologically advanced products, according to the times that we live in, that cover the new needs of the consumer at competitive prices, always **complying with the highest quality standards demanded.**

**Innovación,
confort, diseño y economía**

Un producto que lo tiene todo.

La búsqueda incesantemente de soluciones que mejoren lo conocido, la investigación y el desarrollo de nuevos compuestos más eficientes y sostenibles, la aplicación de las últimas tecnologías y el seguimiento de las tendencias en diseño nos impulsan a ofrecer productos innovadores, tecnológicamente avanzados, acordes a los tiempos que vivimos, que cubran las nuevas necesidades del consumidor a precios competitivos siempre **cumpliendo con los más altos estándares de calidad exigidos.**



CHILD AND PET PROOF

Due to its resistance to impacts, liquids and stains, it is the ideal flooring for use in any room in the house, even in bathrooms and kitchens.

A PRUEBA DE NIÑOS Y MASCOTAS

Por su resistencia a los golpes, a los líquidos y a las manchas es el pavimento ideal para su uso en cualquier estancia de la casa, incluso en baños y cocinas.



EASY CLEANING

No special treatments are necessary for optimal maintenance.

FÁCIL LIMPIEZA

No son necesarios tratamientos especiales para su óptimo mantenimiento.

*All proof!
¡Resistente a todo!*

Technical advantages of MATERIASPC eco-floorings Ventajas técnicas de los eco-pavimentos MATERIASPC



- | | | |
|--|--|--|
| Waterproof
Impermeable | Fireproof
Ignifugo | Acoustically isolating
Aísla acústicamente |
| Scratch resistant
Resistente a rayaduras | Wear resistant
Resistente al desgaste | Impact resistant
Resistente a los golpes |
| Stain resistant
Resistente a las manchas | Without maintenance
Sin mantenimiento | Suitable for wall and floor surfaces
Apto para suelo y pared |
| Suitable for sunny rooms
Ideal para estancias soleadas | UV resistant
Resiste a los rayos UV | Does not dilate
No dilata |
| Anti-slip
Antideslizante | Perfect use between 5°C and 40°C
Uso perfecto entre 5°C y 40°C | Suitable for underfloor heating
Apto para suelos radiantes |
| No toxic or allergic components
Sin componentes tóxicos o alérgicos | Suitable for babies
Apto para bebés | Ideal for pets
Ideal para mascotas |
| Does not generate static electricity
No genera electricidad estática | Bacterial and fungi resistant
Resistente a bacterias y hongos | Resistant to pests
Resistente a las plagas |
| Very realistic finish
Acabado muy realista | 100% Recyclable
100% Reciclable | Installation on any surface
Instalación sobre cualquier superficie |
| Does not need acclimatization
No necesita aclimatación | Effortless
Sin esfuerzo | No works
Sin obras |
| Without joints
Sin juntas | Easy assembly
Fácil Montaje | Quick assembly
Montaje rápido |



The best guarantee of the market La mayor garantía del mercado

A very resistant floor «compound» of benefits

You only have to take a look at these pages to realize the excellence of this new product. **They are the latest generation of vinyl floors that include calcium carbonate.**

We are very satisfied with its long-term performance. The results of the tests carried out demonstrate this and thus we pass it on to the consumer, offering them an almost "lifetime" guarantee that very few dare to match.

Un suelo muy resistente «compuesto» de ventajas

Solo hay que echar un vistazo a estas páginas para darse cuenta de la excelencia de este nuevo producto. **Son la última generación de suelos vinílicos que incluyen carbonato cálcico.**

Estamos muy satisfechos con su rendimiento a largo plazo. Los resultados de los tests realizados así lo demuestran y así se lo trasladamos al consumidor, ofreciéndole una garantía casi "de por vida" que muy pocos se atreven a igualar.

MATERIA SPC eco-floorings versus LVT, WPC and WOOD

Eco-pavimentos MATERIA SPC frente LVT, WPC y MADERA



A deserved excellence

Una merecida excelencia

Floor comparison

Comparative tests carried out against other coatings demonstrate the excellent qualities of our high-quality mineral composite floors, far surpassing vinyl floors manufactured to date.

Undoubtedly, **arguments of great weight when deciding the purchase decision** over other products.

An unrivaled coating for all types of interiors.

Comparativa de suelos

Las pruebas comparativas realizadas con respecto a otros recubrimientos demuestran las excelentes cualidades de nuestros pavimentos de composite mineral de alta calidad, superando por mucho a los suelos vinílicos fabricados hasta la fecha.

Sin duda, **argumentos de mucho peso a la hora de decantar la decisión de compra** frente a otros productos.

Un revestimiento para todo tipo de interiores sin rival.

	MATERIASPC	LVT	WPC	MADERA
Waterproof Resistencia al agua				
No expansion or contraction Sin dilatación ni contracción				
High/low temperature stability Estabilidad en alta/baja temperatura				
Installation on any surface Instalación sobre cualquier superficie				
Scratch resistant Resistente a rayaduras				
Soundproofing capacity Capacidad de insonorización				
Pet friendly Apto para mascotas				
Easy assembly Fácil instalación				
Suitable for sunny rooms Adecuado para estancias soleadas				
Free of formaldehyde Libre de formaldehídos				
Impact resistant Resistente a los impactos				

Laying the MATERIASPC eco-floorings Colocación de los eco-pavimentos MATERIASPC

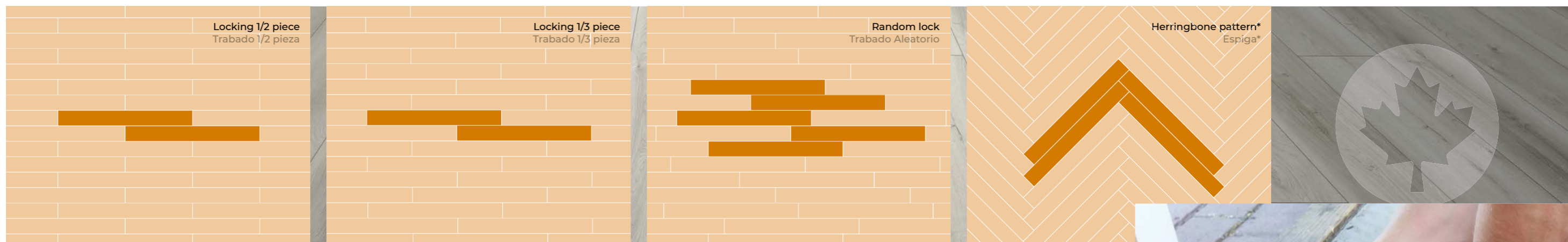

Fit, CLICK... and voilà!
Encajar, CLICK... ¡Y listo!

Much easier than assembling a puzzle

It does not matter on which surface our MATERIASPC floors are installed: cement, concrete, old ceramic floors, wood ... the only requirement is that the surface **be solid, smooth and dry**.

No adhesives or additional supports.
No dust. No debris. Effortless.

Mucho más sencillo que montar un puzle

No importa sobre qué superficie se instalen nuestros suelos MATERIASPC: cemento, hormigón, antiguos pavimentos cerámicos, madera... el único requisito es que la superficie **sea sólida, lisa y seca**.

Sin adhesivos ni soportes adicionales.
Sin polvo. Sin escombros. Sin esfuerzo.



See assembly instructions
Ver instrucciones de montaje

DIFFERENT POSSIBILITIES OF PLACEMENT DISTINTAS POSIBILIDADES DE COLOCACIÓN



NO PRIOR KNOWLEDGE REQUIRED
It is so simple to assemble that anyone can install MATERIASPC floors with the few tools necessary..

SIN CONOCIMIENTOS PREVIOS
Es tan sencillo de ensamblar que cualquiera puede instalar los suelos MATERIASPC disponiendo de las pocas herramientas necesarias.

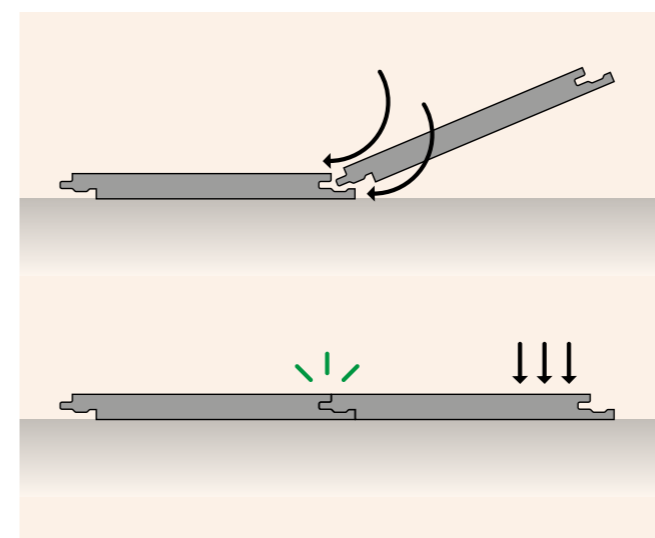

*** HERRINGBONE PATTERN / COLOCACIÓN EN ESPIGA**
Available only for a minimum order quantity of sqm.
Delivery terms to be confirmed.
Disponibles solo bajo pedido para una cantidad mínima de m².
Consulte plazos de entrega.



FLOOR AND WALL SUITABLE
APTO PARA SUELO Y PARED



WITHOUT EXPANSION JOINTS
They are not necessary except in cases where the surface to be covered exceeds 15 m from end to end.

SIN JUNTAS DE DILATACIÓN
No son necesarias salvo en casos en los que la superficie a cubrir supere los 15 m de extremo a extremo.

Logistics & Service
Logística & Servicio



Immediate replacement service
Servicio inmediato de reposición

5 business days
to any point of Spain and Portugal

The quantity does not matter. From our logistics center we guarantee the delivery of your order in record time.

You will save space in your facilities by not needing to store product stock and peace of mind knowing that your order will be delivered in the set time.

No delays.

5 días hábiles
a cualquier punto de la península

No importa la cantidad. Desde nuestro centro logístico garantizamos la entrega de su pedido en tiempo récord.

Ganará espacio en sus instalaciones al no necesitar almacenar stock de producto y tranquilidad al saber que su pedido será entregado en el tiempo fijado.

Sin retrasos.

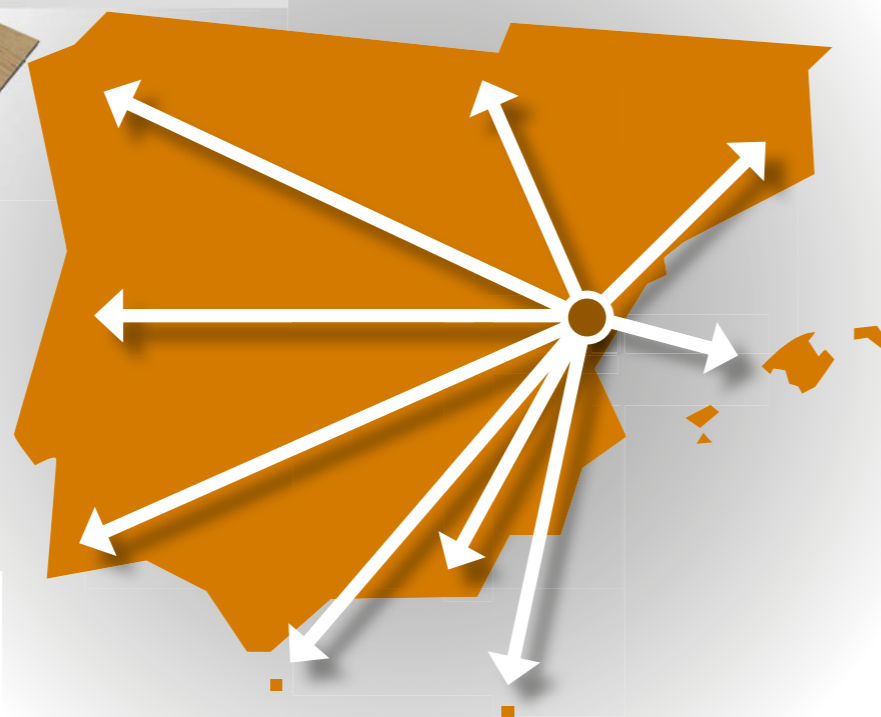

Large projects Grandes proyectos



FOR LARGE ORDERS (several containers)

We put at your disposal our exclusive «à la carte» product service with which you can create your own configuration of the piece combining materials and layer thicknesses based on the technical, aesthetic and economic requirements of the final product you want to obtain.

PARA GRANDES PEDIDOS (varios contenedores)

Ponemos a su disposición nuestro servicio exclusivo de producto «a la carta» con el que podrá crear su propia configuración de la pieza, combinando materiales y espesores de las capas en función de los requisitos técnicos, estéticos y económicos del producto final que desee obtener.



Manufacture «à la carte» Fabricación «a la carta»

Make your own pavement «recipe»

We put at your disposal all our **manufacturing potential** to adhere to your specifications based on your needs, covering all the technical aspects of the final product, combinations of materials and thicknesses, advice, dimensions, finishes and of course design, **to create the perfect flooring** that your big project requires. Always within the required quality standards.

We are open to any proposal that you could make us. **Contact us.**

Confeccione su propia «receta» de pavimento

Ponemos a su disposición todo nuestro **potencial de fabricación** para ceñirnos a sus especificaciones técnicas en función de sus necesidades, abarcando todos los aspectos técnicos del producto final, combinaciones de materiales y espesores, asesoramiento, dimensiones, acabados y por supuesto diseño, **para crear el pavimento perfecto** que requiere su gran proyecto. Siempre dentro de los estándares de calidad exigidos.

Estamos abiertos a cualquier propuesta que pueda realizarnos. **Contacte con nosotros.**

WOOD SERIES
COLECCIÓN MADERAS



SAPIN

WHITE



SAPIN

BEIGE



SAPIN

HAYA



SAPIN

GREY



WHITE

WOOD SERIES
COLECCIÓN MADERAS

SAPIN



SAPIN HAYA
18,2 x 122 cm - 7,2" x 48"
22,8 x 154 cm - 9" x 60,6"

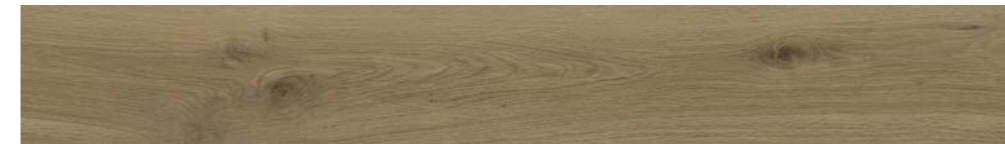

SAPIN BEIGE
18,2 x 122 cm - 7,2" x 48"
22,8 x 154 cm - 9" x 60,6"



SAPIN GREY
18,2 x 122 cm - 7,2" x 48"
22,8 x 154 cm - 9" x 60,6"



SAPIN WHITE
18,2 x 122 cm - 7,2" x 48"
22,8 x 154 cm - 9" x 60,6"

Floor and wall suitable
Apto para suelo y pared



Total thickness (mm)
Espesor total (mm)



Thickness core (mm)
Espesor del núcleo (mm)



Total thickness (mm)
Espesor total (mm)



Thickness core (mm)
Espesor del núcleo (mm)



22,8 x 154 cm
18,2 x 122 cm

Wear layer
Capa de uso



IR. Deep relief
IR. Relieve intenso



Microbevelled edge
Micro-bisel



Underlayment for acoustic isolation
Manto de Aislamiento Acústico



14F Angle Click
14F Click angular



Waterproof
Impermeable



Anti slip - R10
Antideslizante - R10



**Available formats
in all colors**
Formatos disponibles
en todos los colores

22,8 x 154 cm
9" x 60,6"

18,2 x 122 cm
7,2" x 48"



Coordinated steps, skirtings & profiles
Peldaños, rodapiés y perfiles coordinados



Check stock availability
Consultar disponibilidad de stock

DEEP RELIEF - RELIEVE INTENSO



WOOD SERIES
COLECCIÓN MADERAS

NOYER

HAYA



NOYER

BEIGE



HAYA

WOOD SERIES
COLECCIÓN MADERAS

NOYER



NOYER BEIGE

18,2 x 122 cm - 7,2" x 48"
22,8 x 154 cm - 9" x 60,6"



NOYER HAYA

18,2 x 122 cm - 7,2" x 48"
22,8 x 154 cm - 9" x 60,6"

Floor and wall suitable
Apto para suelo y pared

Total thickness (mm)
Espesor total (mm) 5,5

Thickness core (mm)
Espesor del núcleo (mm) 4,5

Total thickness (mm)
Espesor total (mm) 5

Thickness core (mm)
Espesor del núcleo (mm) 4

22,8 x 154 cm
18,2 x 122 cm

Wear layer
Capa de uso 0,5 mm

IR. Deep relief
IR. Relieve intenso

Microbevelled edge
Micro-bisel MICRO

Underlayment for acoustic isolation
Manto de Aislamiento Acústico 1mm EVA

14F Angle Click
14F Click angular CLICK

Waterproof
Impermeable 100%

Anti slip - R10
Antideslizante - R10

Available formats
in all colors
Formatos disponibles
en todos los colores

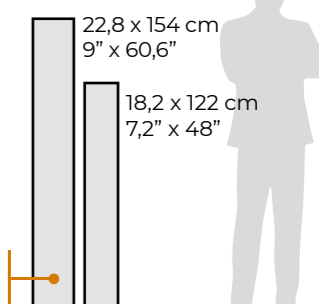

Coordinated steps, skirtings & profiles
Peldaños, rodapiés y perfiles coordinados



DEEP RELIEF - RELIEVE INTENSO

WOOD SERIES
COLECCIÓN MADERAS

ARANCIO

LIGHT GREY



ARANCIO

BEIGE



ARANCIO

NUT



ARANCIO



ARANCIO LIGHT GREY
18,2 x 122 cm - 7,2" x 48"
22,8 x 154 cm - 9" x 60,6"



ARANCIO TAUPE
18,2 x 122 cm - 7,2" x 48"
22,8 x 154 cm - 9" x 60,6"



ARANCIO BEIGE
18,2 x 122 cm - 7,2" x 48"
22,8 x 154 cm - 9" x 60,6"



ARANCIO BROWN
18,2 x 122 cm - 7,2" x 48"
22,8 x 154 cm - 9" x 60,6"



ARANCIO NUT
18,2 x 122 cm - 7,2" x 48"
22,8 x 154 cm - 9" x 60,6"

Floor and wall suitable
Apto para suelo y pared

Total thickness (mm)
Espesor total (mm) 5,5

Thickness core (mm)
Espesor del núcleo (mm) 4,5

Total thickness (mm)
Espesor total (mm) 5

Thickness core (mm)
Espesor del núcleo (mm) 4

22,8 x 154 cm

18,2 x 122 cm

Wear layer
Capa de uso 0,5 mm

Standard relief
Relieve estándar

Microbevelled edge
Micro-bisel MICRO

Underlayment for acoustic isolation
Manto de Aislamiento Acústico 1mm EVA

14F Angle Click
14F Click angular CLICK

Waterproof
Impermeable 100%

Anti slip - R10
Antideslizante - R10

**Available formats
in all colors**
Formatos disponibles
en todos los colores

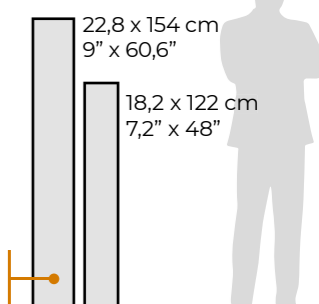

Coordinated steps, skirtings & profiles
Peldaños, rodapiés y perfiles coordinados



Check stock availability
Consultar disponibilidad de stock



WOOD SERIES
COLECCIÓN MADERAS

BETULLA

BONE



BETULLA

NATURAL



BETULLA

GREY



NATURAL

WOOD SERIES
COLECCIÓN MADERAS

BETULLA



BETULLA BONE
18,2 x 122 cm - 7,2" x 48"
22,8 x 154 cm - 9" x 60,6"



BETULLA NATURAL
18,2 x 122 cm - 7,2" x 48"
22,8 x 154 cm - 9" x 60,6"

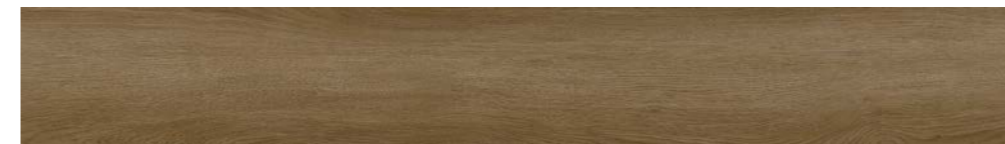

BETULLA ROBLE
18,2 x 122 cm - 7,2" x 48"
22,8 x 154 cm - 9" x 60,6"



BETULLA GREY
18,2 x 122 cm - 7,2" x 48"
22,8 x 154 cm - 9" x 60,6"

Floor and wall suitable
Apto para suelo y pared



Total thickness (mm)
Espesor total (mm)



Thickness core (mm)
Espesor del núcleo (mm)



Total thickness (mm)
Espesor total (mm)



Thickness core (mm)
Espesor del núcleo (mm)



22,8 x 154 cm

18,2 x 122 cm

Wear layer
Capa de uso



Standard relief
Relieve estándar



Microbevelled edge
Micro-bisel



Underlayment for acoustic isolation
Manto de Aislamiento Acústico



14F Angle Click
14F Click angular



Waterproof
Impermeable



Anti slip - R10
Antideslizante - R10



**Available formats
in all colors**
Formatos disponibles
en todos los colores

22,8 x 154 cm
9" x 60,6"

18,2 x 122 cm
7,2" x 48"



Coordinated steps, skirtings & profiles
Peldaños, rodapiés y perfiles coordinados



Check stock availability
Consultar disponibilidad de stock

WOOD SERIES
COLECCIÓN MADERAS

CARRUBO

BEIGE



CARRUBO

BEIGE



CARRUBO



CARRUBO BEIGE
18,2 x 122 cm - 7,2" x 48"
22,8 x 154 cm - 9" x 60,6"



CARRUBO COFFEE
18,2 x 122 cm - 7,2" x 48"
22,8 x 154 cm - 9" x 60,6"



CARRUBO BLANCO
18,2 x 122 cm - 7,2" x 48"
22,8 x 154 cm - 9" x 60,6"

Floor and wall suitable
Apto para suelo y pared



Total thickness (mm)
Espesor total (mm)



Thickness core (mm)
Espesor del núcleo (mm)



Total thickness (mm)
Espesor total (mm)



Thickness core (mm)
Espesor del núcleo (mm)



22,8 x 154 cm

18,2 x 122 cm

Wear layer
Capa de uso



Standard relief
Relieve estándar



Microbevelled edge
Micro-bisel



Underlayment for acoustic isolation
Manto de Aislamiento Acústico



14F Angle Click
14F Click angular



Waterproof
Impermeable



Anti slip - R10
Antideslizante - R10



**Available formats
in all colors**
Formatos disponibles
en todos los colores

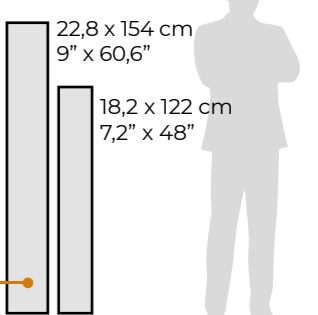

Coordinated steps, skirtings & profiles
Peldaños, rodapiés y perfiles coordinados



Check stock availability
Consultar disponibilidad de stock



WOOD SERIES
COLECCIÓN MADERAS

LECCIO

WHITE



LECCIO

GREY



LECCIO



LECCIO HAYA
18,2 x 122 cm - 7,2" x 48"
22,8 x 154 cm - 9" x 60,6"



LECCIO BEIGE
18,2 x 122 cm - 7,2" x 48"
22,8 x 154 cm - 9" x 60,6"



LECCIO WHITE
18,2 x 122 cm - 7,2" x 48"
22,8 x 154 cm - 9" x 60,6"



LECCIO GREY
18,2 x 122 cm - 7,2" x 48"
22,8 x 154 cm - 9" x 60,6"

Floor and wall suitable
Apto para suelo y pared

Total thickness (mm)
Espesor total (mm) 5,5

Thickness core (mm)
Espesor del núcleo (mm) 4,5

Total thickness (mm)
Espesor total (mm) 5

Thickness core (mm)
Espesor del núcleo (mm) 4

22,8 x 154 cm

18,2 x 122 cm

Wear layer
Capa de uso 0,5 mm

Standard relief
Relieve estándar

Microbevelled edge
Micro-bisel MICRO

Underlayment for acoustic isolation
Manto de Aislamiento Acústico 1 mm EVA

14F Angle Click
14F Click angular CLICK

Waterproof
Impermeable 100%

Anti slip - R10
Antideslizante - R10

**Available formats
in all colors**
Formatos disponibles
en todos los colores

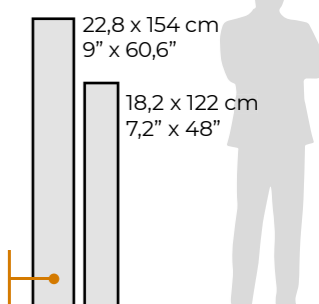

Coordinated steps, skirtings & profiles
Peldaños, rodapiés y perfiles coordinados



Check stock availability
Consultar disponibilidad de stock

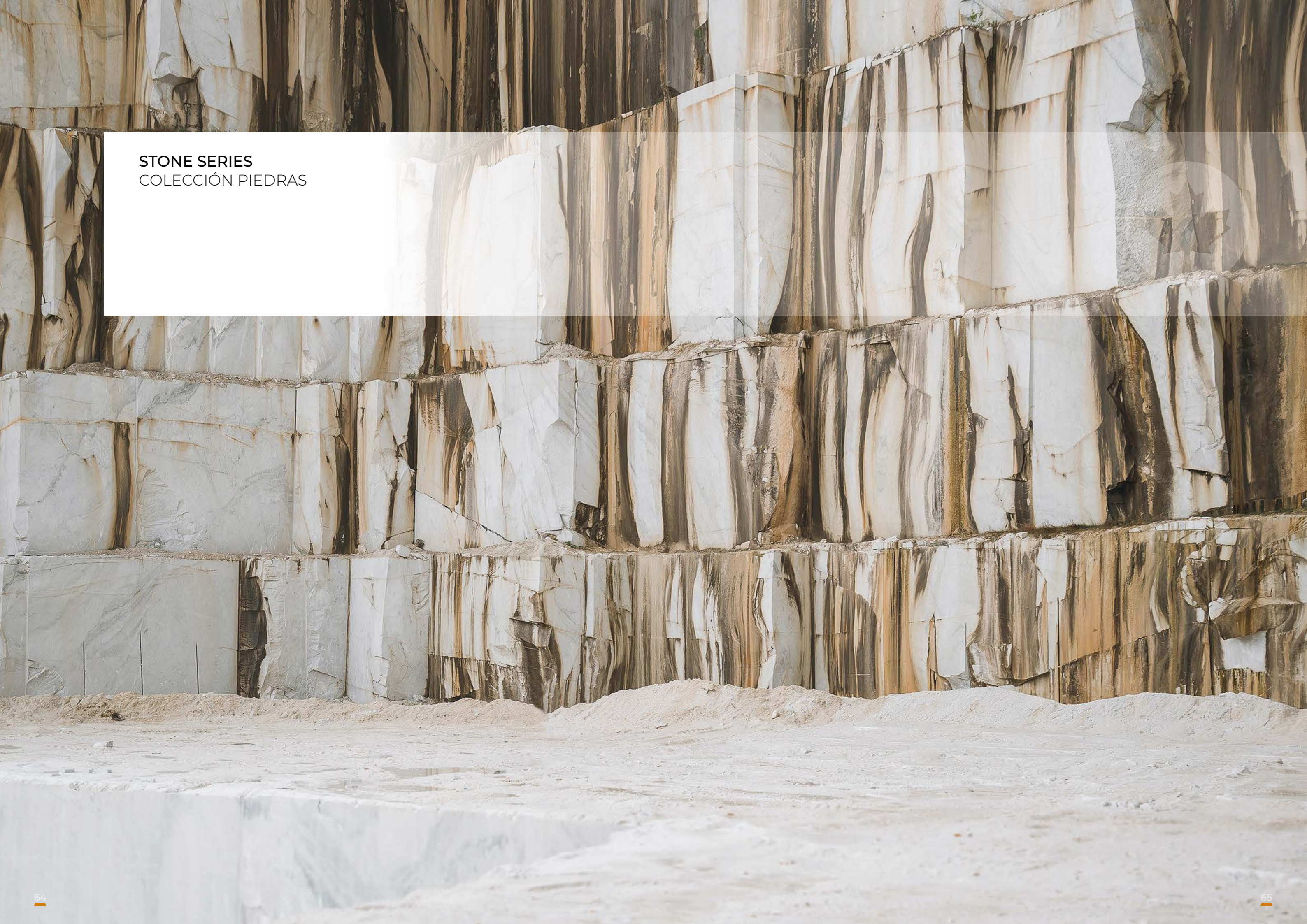











STONE SERIES
COLECCIÓN PIEDRAS

MARBLE



MARBLE CRISTAL
30,5 x 61 cm - 12" x 24"
46 x 92 cm - 18,1" x 36,2"

- Floor and wall suitable
Apto para suelo y pared 
- Total thickness (mm)
Espesor total (mm) **5,5**
- Thickness core (mm)
Espesor del núcleo (mm) **4,5**
- Wear layer
Capa de uso **0,3 mm**
- Standard relief
Relieve estándar 
- Microbevelled edge
Micro-bisel **MICRO**
- Underlayment for acoustic isolation
Manto de Aislamiento Acústico **1mm EVA**
- I4F Angle Click
I4F Click angular **CLICK**
- Waterproof
Impermeable **100%**
- Anti slip - R10
Antideslizante - R10 

**Available formats
in all colors**
Formatos disponibles
en todos los colores

46 x 92 cm
18,1" x 36,2"
30,5 x 61 cm
12" x 24"

Check stock availability
Consultar disponibilidad de stock

Coordinated steps, skirtings & profiles
Peldaños, rodapiés y perfiles coordinados





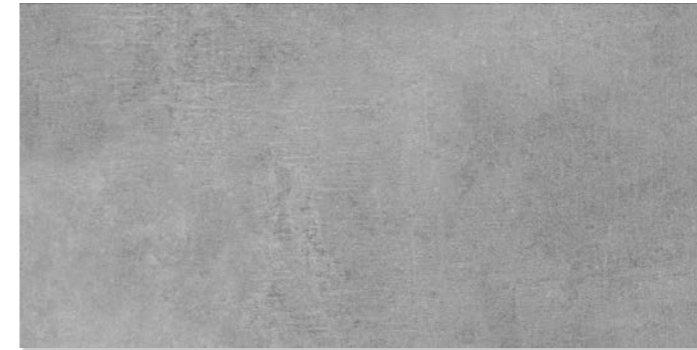







STONE



STONE GRAFITO
30,5 x 61 cm - 12" x 24"
46 x 92 cm - 18,1" x 36,2"



STONE NÁCAR
30,5 x 61 cm - 12" x 24"
46 x 92 cm - 18,1" x 36,2"

- Floor and wall suitable
Apto para suelo y pared 
- Total thickness (mm)
Espesor total (mm) 
- Thickness core (mm)
Espesor del núcleo (mm) 
- Wear layer
Capa de uso 
- Standard relief
Relieve estándar 
- Microbevelled edge
Micro-bisel 
- Underlayment for acoustic isolation
Manto de Aislamiento Acústico 
- I4F Angle Click
I4F Click angular 
- Waterproof
Impermeable 
- Anti slip - R10
Antideslizante - R10 

**Available formats
in all colors**
Formatos disponibles
en todos los colores

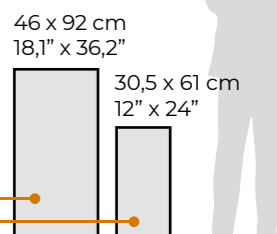

Check stock availability
Consultar disponibilidad de stock

Coordinated steps, skirtings & profiles
Peldaños, rodapiés y perfiles coordinados





THE STEPS ARE MADE TO ORDER

For safety reason, they must be glued to the support to guarantee they stay attached and in place. Support refers to the spot where they are glued to.

LOS PELDAÑOS SE FABRICAN BAJO PEDIDO

Por motivos de seguridad deberán ser pegados al soporte mediante cola para garantizar su fijación.

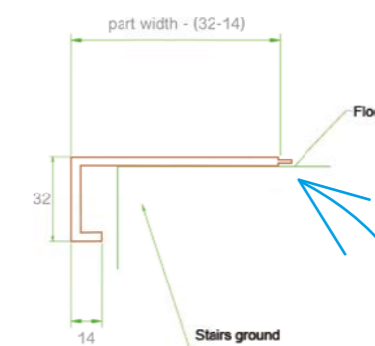

Step
Peldaño

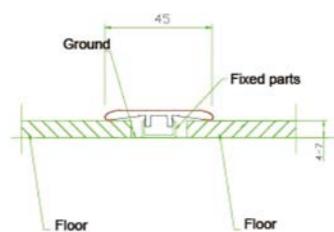

Expansion joint
Junta de dilatación

JOINT EVERY 15 mL RECOMMENDED

They are not necessary except in cases where the surface to be covered exceeds 15 m from end to end.

JUNTA RECOMENDADA CADA 15 m

No son necesarias salvo en casos en los que la superficie a cubrir supere los 15 m de extremo a extremo.



T strip
Perfil de dilatación

45 x 2200 mm

Special parts / Appliances
Piezas especiales / Accesorios

Coordinated steps, skirtings & profiles
Peldaños, rodapiés y perfiles coordinados



Transition strip
Perfil de transición

45 x 2200 x 3 mm



Skirting
Rodapié

70 x 2200 x 10 mm

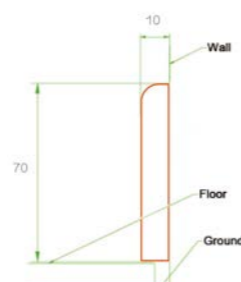
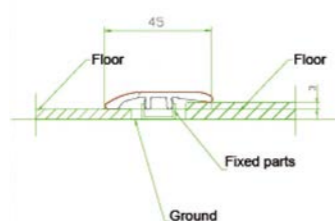

Finishes that match your pavement

We constantly expand our catalog of profiles and accessories for finishes.

If you do not find what you are looking for here, **visit our website or contact us**. We will find the perfect solution to finish your project with the excellence you always deserve at a very competitive price.

Acabados que combinan con su pavimento

Ampliamos constantemente nuestro catálogo de perfiles y accesorios para acabados.

Si no encuentra aquí el perfil que necesita **visite nuestra web o contacte con nosotros**. Encontraremos la solución perfecta para rematar su proyecto con la excelencia que se merece, siempre a un precio muy competitivo.

Technical data

Información técnica



Test and certificates

Ensayos y certificados

ANALISED CHARACTERISTIC CARACTERÍSTICA ANALIZADA	STANDARD NORMA	UNITS UNIDADES	RESULT RESULTADO
Dimensions Dimensiones	ISO 24337:2006	mm x mm	182 x 1220mm / 305 x 610mm
Thickness Espesor	EN ISO 24346	mm	5,0 mm
Thickness tolerance of wear layer Tolerancia de espesor de la capa de desgaste	EN ISO 24340	mm	+13%, -10%
Wear resistance IP 0,5 Resistencia de la capa de uso IP 0,5	EN 13329	Class Clase	AC6-Class 33 / AC6-Clase 33 Heavy commercial traffic - Tráfico comercial intenso
Formaldehyde Emission Emisión de formaldehído	EN 12149:1997 Test C	mg/m ³	Not detected No detectado
Vinyl Chloride Monomer Monómero de cloruro de vinilo	EN 12149:1997 Test B	mg/kg	Not detected No detectado
Soluble cadmium Cadmio soluble	EN 71-3:1994+AC:2002	mg/m ³	Not detected No detectado
DEHP+BBP+DBP	EN 13372		Not detected No detectado
DNOP+DIDP+DINP	EN 13372		Not detected No detectado
Testing of fire resistance Prueba de resistencia al fuego	EN 13501-1	Class Clase	Class B1 (B- s1,t0) / Clase B1 (B- s1,t0)
Residual indentation Huella residual	ISO 24343-1:2012	mm	≤ 0,1 mm
Peeling strength Resistencia al despegado	ISO 24345	mm	≥ 70 N/50mm
Click tension force Determinación de la fuerza de bloqueo para paneles ensamblados con sistema click	ISO 24334	kN/m	≥ 3 kN/m
Resistance to staining Resistencia a las manchas	EN 26987		No contamination or corrosion Sin contaminación ni corrosión
Curling after exposure to heat Determinación de la estabilidad dimensional y el encorvamiento después de la exposición al calor	ISO 23999	mm	≤ 1 mm
Dimensional Stability Estabilidad dimensional	ISO 24337:2006	%	≤ 0,15 %
Installation gap of click flooring Hueco en la instalación de suelos con clic	ISO 24337:2006	mm	≤ 0,15 mm
Slip resistance Resistencia al deslizamiento	DIN 51130:2014	Group Grupo	R10

Technical information
Información técnica

Packing list and displays
Embalajes y expositores

STONE SERIES COLECCIÓN PIEDRAS | WOOD SERIES COLECCIÓN MADERAS

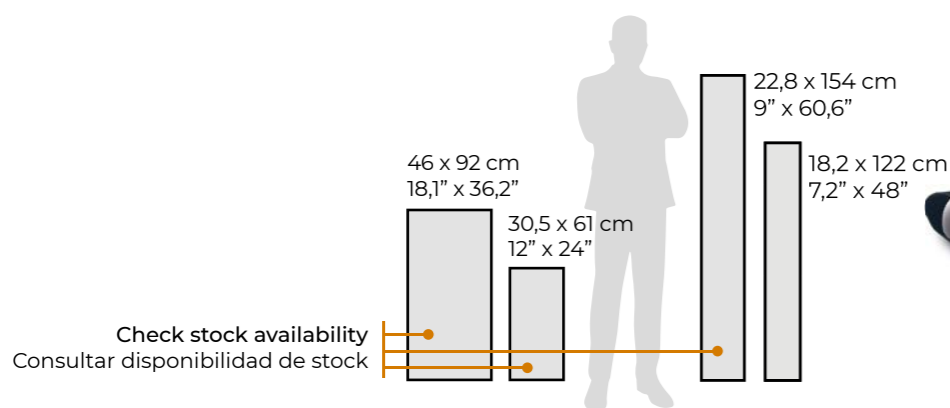

mm - inch										
SIZE TAMAÑO	SPECIFICATION ESPECIFICACIONES	PCS / BOX PZS / CAJA	S.Q.M. / BOX m ² / CAJA	Kg / BOX Kg / CAJA	BOX / PALLET CAJAS / PALLET	S.Q.M. / PALLET m ² / PALLET	Kg / PALLET Kg / PALLET	PALLETS / CTN	S.Q.M. / CTN m ² / CTN	
182 x 1220 - 7,2" x 48"	4.0mm/0.5mm SPC+1mm Eva	10	2,22	18,30	64	142,08	1.170,95	22	3.126,32	
228 x 1540 - 9" x 60,6"	4.5mm/0.5mm SPC+1mm Eva	6	2,11	19,53	60	126,60	1.171,76	21	2.654,47	
305 x 610 - 12" x 24"	4.5mm/0.3mm SPC+1mm Eva	8	1,49	13,56	66	98,34	895	28	2.750,56	
460 x 920 - 18,1" x 36,2"	4.5mm/0.3mm SPC+1mm Eva	5	2,12	19,26	66	139,92	1.271	20	2.793,12	



Important consumer information
Información importante para el consumidor

Disassemble, move, reassemble... Desmontar, trasladar, volver a montar...

Your home style moves with you

MATERIASPC adapts to the lifestyle of those who, due to circumstances, have a higher geographical mobility.

Furniture, household items, textiles, souvenirs are moved during the removals ... Everything that we like and want to be part of our life.

MATERIASPC floors also move with you to help you create the warmth of your home wherever you are.

El estilo de tu hogar se mueve contigo

MATERIASPC se adapta al estilo de vida de aquellos que, por circunstancias, tienen una movilidad geográfica superior.

En las mudanzas se desplazan muebles, menaje, textiles, recuerdos... Todo aquello que nos gusta y deseamos que forme parte de nuestra vida.

Los suelos MATERIASPC también se mudan contigo para ayudarte a crear allá donde estés la calidez de tu hogar.



No CO₂ footprint and 100% recyclable Sin huella de CO₂ y reciclable 100%

Empowering a circular economy

Better use of resources and less waste generation to increase sustainability and take care of the environment. This is our philosophy.

We produce our MATERIASPC floors exclusively with electrical energy from 100% renewable sources (80% from our own solar panels) generating a zero footprint in CO₂ emissions and **we minimize the generation of waste** by reincorporating the remains of the raw materials used. The quality of our products **allows them to be reused**, extending their useful life, in addition to not being necessary other products (such as adhesives or additional supports) during their installation, resulting in **a fully recyclable product** once its cycle of use is over.

Potenciando una economía circular

Mayor aprovechamiento de los recursos y menos generación de residuos para incrementar la sostenibilidad y cuidar el medio ambiente. Esta es nuestra filosofía.

Producimos nuestros suelos MATERIASPC exclusivamente con energía eléctrica procedente de fuentes 100% renovables (el 80% procedente de paneles solares propios) generando una huella nula en emisiones de CO₂ y **reducimos al mínimo la generación de residuos** reincorporando de nuevo al proceso de fabricación los restos de las materias primas empleadas. La calidad de nuestros productos **permite su reutilización** alargando su vida útil, además de no ser necesarios otros productos (como adhesivos o soportes adicionales) durante su instalación, dando como resultado **un producto totalmente reciclable** una vez finalizado su ciclo de uso.



By **EAST COAST SPC, S.A.**



Households
Viviendas



Commercial premises
Locales comerciales

www.materiaspc.com

