

OutWalk 23 • 24

OUTDOOR SOLUTIONS

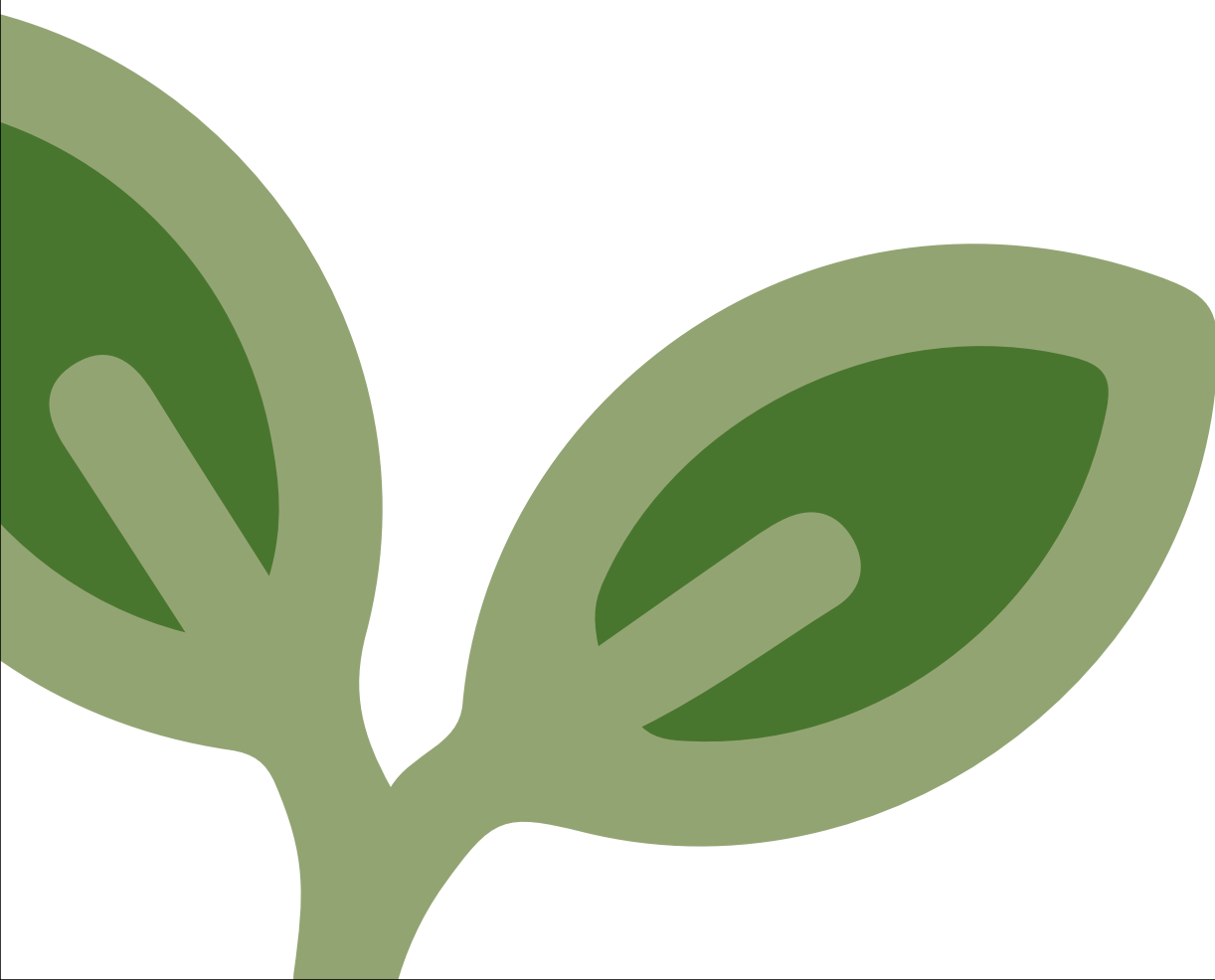

NovaBell



Cover Photo by Sebastian Pichler

NovaBell
OutWalk 20/30
MM/MM

 **NovaBell**

INDICE ANALITICO

SUBJECT INDEX / INDEX ANALYTIQUE / STICHWORTVERZEICHNIS

INTRODUZIONE / INTRODUCTION

- 4_ CERAMIC LOVE STORY SINCE 1988
- 6_ SMART FACTORY
- 8_ QUALITY AND SUSTAINABLE AND CIRCULAR DEVELOPMENT
- 10_ OUTDOOR STYLE
- 12_ OUTDOOR PLUS
- 13_ OUTDOOR TEST AND PERFORMANCE
- 14_ OUTDOOR COMPLETE PROJECT
- 16_ 6 LAYING OPTIONS
- 18_ MULTISIZE
- 20_ ACCESSORIES SWIMMING POOL
- 22_ ACCESSORIES STAIRS
- 25_ FURNISHING & ACCESSORIES
- 26_ COPINGS
- 27_ FENCE
- 28_ BRICKUP
- 30_ 3 CM

COLLEZIONI / COLLECTIONS

- 32_ PRODUCT INSPIRATIONS

STONE / PIETRA

- 36_ LANDSTONE
- 38_ MAXIMA
- 40_ LOUNGE
- 42_ THERMAE
- 44_ ASPEN
- 46_ STONE BOX
 - PAVED
 - URBE
 - DOLOMIA
 - BLUE STONE
 - GIAVA MULTICOLOR
- 56_ NORGESTONE
- 58_ DAVOS
- 60_ ALLBLACK
- 62_ SOVEREIGN
- 64_ KINGSTONE
- 66_ IMPERIAL VENICE

WOOD / LEGNO

- 70_ NORDIC WOOD
- 72_ NORDIC WOOD FLAMED
- 74_ ARTWOOD
- 76_ EICHE
- 78_ MY SPACE
- 80_ TIME DESIGN
- 82_ QUERCUS

METAL & CONCRETE / METALLO E CEMENTO

- 86_ FORGE
- 88_ OPEN
- 90_ OXY
- 92_ OVERLAND

RUSTICO / RUSTIC

- 96_ LUMIÈRE
- 98_ MATERIA

TECHNICAL INFO

- 102_ SPECIAL TRIMS
- 104_ SLABS FOR STEPS
- 105_ PACKAGING AND WEIGHTS
- 106_ INSTALLATION SYSTEM
- 116_ TECHNICAL INFO
- 118_ MERCHANDISING

INDICE ALFABETICO

ALPHABETICAL INDEX
INDEX ALPHABETIQUE
ALPHABETISCHES INHALTSVERZEICHNIS

- 60_ ALLBLACK
- 74_ ARTWOOD
- 44_ ASPEN
- 58_ DAVOS
- 76_ EICHE
- 86_ FORGE
- 66_ IMPERIAL VENICE
- 64_ KINGSTONE
- 36_ LANDSTONE
- 40_ LOUNGE
- 96_ LUMIÈRE
- 98_ MATERIA
- 38_ MAXIMA
- 78_ MY SPACE
- 70_ NORDIC WOOD
- 72_ NORDIC WOOD FLAMED
- 56_ NORGESTONE
- 88_ OPEN
- 92_ OVERLAND
- 90_ OXY
- 82_ QUERCUS
- 62_ SOVEREIGN
- 46_ STONE BOX
 - PAVED
 - URBE
 - DOLOMIA
 - BLUE STONE
 - GIAVA MULTICOLOR
- 42_ THERMAE
- 80_ TIME DESIGN

INDICE FORMATI - EFFETTI

INDEX OF SIZES - EFFECTS / INDEX FORMATS - EFFETS / VERZEICHNIS DER FORMATE - OPTIKEN

EFFETTI LOOKS	COLLEZIONI COLLECTIONS	PAG.	20 MM						30 MM										
			cm 100x100	cm 80x80	cm 60x180	cm 30x180	cm 60x90	MULTISIZE	cm 60x120	cm 40x120	cm 30x120	cm 20x120	cm 60x60	cm 30x60	cm 80x80	cm 40x80	cm 60x60		
PIETRA STONE	LANDSTONE	36	●				●	●					●						
	MAXIMA	38							●										
	LOUNGE	40	●	●			●	●	●				●	●	●	●	●		
	THERMAE	42	●				●	●	●				●	●	●	●	●		
	ASPEN	44	●		●		●	●	●				●	●	●	●	●		
	STONE BOX	PAVED	46							●				●					
		URBE						●	●					●	●				
		DOLOMIA														●			
		BLUE STONE						●	●	●					●				
		GIAVA MULTICOLOR						●	●	●					●				
	NORGESTONE	56			●		●	●	●				●	●	●	●	●		
	DAVOS	58					●	●					●						
ALLBLACK	60					●	●					●							
SOVEREIGN	62					●	●					●							
KINGSTONE	64		●									●							
IMPERIAL VENICE	66											●							
LEGNO WOOD	NORDIC WOOD	70			●				●		●		●						
	NORDIC WOOD FLAMED	72											●						
	ARTWOOD	74				●				●	●								
	EICHE	76				●				●	●	●							
	MY SPACE	78								●	●		●						
	TIME DESIGN	80								●	●								
QUERCUS	82									●									
METALLO & CEMENTO METAL & CONCRETE	FORGE	86		●															
	OPEN	88		●					●				●		●		●		
	OXY	90	●	●															
	OVERLAND	92		●															
RUSTICO RUSTIC	LUMIÈRE	96					●	●					●						
	MATERIA	98											●						

NovaBell
OutWalk 20/30
MM/MM

A CERAMIC LOVE STORY SINCE 1988.



UNA STORIA DI PASSIONE PER LA CERAMICA DAL 1988.

Il marchio NovaBell è indissolubilmente legato alla famiglia Bellei. Il fondatore, Silvio Bellei, è stato fin dagli anni '50 tra i principali protagonisti dell'industria ceramica italiana, partecipando allo sviluppo di alcune tra le più importanti aziende del settore. **Oggi NovaBell è un'eccellenza ceramica, un modello di impresa impegnato nel miglioramento continuo dell'efficienza dei processi produttivi e delle performance ambientali, elementi determinanti per ottenere prodotti di qualità.**

A CERAMIC LOVE STORY SINCE 1988.

The NovaBell brand is inextricably linked to the Bellei family. Its founder, Silvio Bellei, played a leading role in the Italian ceramic industry from the 1950s onwards, contributing to the development of some of the most important companies in the sector. **Today NovaBell stands for excellence in the ceramics industry, a business model committed to continual improvement in the efficiency of production processes and environmental performance, crucial for the manufacture of quality products.**

UNE HISTOIRE DE PASSION POUR LA CÉRAMIQUE DEPUIS 1988.

La famille Bellei est indissolublement liée à la marque NovaBell. Dès les années 50, son fondateur, Silvio Bellei, est déjà l'un des acteurs majeurs de l'industrie céramique italienne, contribuant largement au développement de plusieurs grandes entreprises du secteur. **NovaBell est aujourd'hui une excellence céramique, un modèle d'entreprise engagé à optimiser sans cesse l'efficacité de ses procédés de production et de ses performances environnementales, soit des éléments essentiels pour fabriquer des produits de qualité.**

KERAMIK AUS LEIDENSCHAFT, EIN UNTERNEHMEN SCHREIBT GESCHICHTE - SEIT 1988.

Die Marke NovaBell ist untrennbar mit der Familie Bellei verknüpft. Der Gründer Silvio Bellei gehörte bereits in den 50er Jahren zu den Schlüsselfiguren der italienischen Keramikindustrie, da er an der Entwicklung einiger der renommiertesten Branchenunternehmen beteiligt war. **NovaBell steht heute für hochwertige Keramik. Das Geschäftsmodell setzt auf eine Verbesserung der Produktionseffizienz und des Umweltprofils, entscheidende Elemente für die Erzielung von Qualitätsprodukten.**





SMART FACTORY: TANGIBLE, MEASURABLE SUSTAINABILITY.

SMART FACTORY: LA SOSTENIBILITÀ CONCRETA E MISURABILE.

La componente ambientale ha assunto un peso sempre più rilevante nella programmazione e negli investimenti NovaBell. L'ampliamento dello stabilimento, le tecnologie 4.0 e le nuove infrastrutture nascono da un vero e proprio ripensamento dell'intero processo industriale che vede la sostenibilità come una priorità strategica. L'azienda contribuisce attivamente attraverso una serie di azioni concrete e misurabili:

- riduzione pari a 500 tonnellate di CO₂ l'anno
- riduzione del 7% dei consumi energetici
- 99,5% degli scarti recuperati nel ciclo produttivo
- 8,5% in meno di estrazione di materie prime
- digitalizzazione 4.0 per innovare processi, prodotti e servizi
- nuova viabilità e infrastrutture resilienti.

SMART FACTORY : LA DURABILITÉ CONCRÈTE ET MESURABLE.

La composante environnementale joue un rôle de plus en plus important dans la programmation et les investissements NovaBell. L'agrandissement de l'usine, les technologies 4.0 et les nouvelles infrastructures reposent sur la révision complète de tout le procédé industriel qui pose comme priorité stratégique la durabilité. L'entreprise s'engage activement par une série d'actions concrètes et mesurables :

- réduction de 500 tonnes de CO₂ par an
- réduction de 7 % des consommations énergétiques
- récupération de 99,5 % des déchets dans le cycle de production
- 8,5 % en moins d'extraction de matières premières
- digitalisation 4.0 pour innover procédés, produits et services
- nouvelle gestion de la circulation et infrastructures résilientes.

SMART FACTORY: LA SOSTENIBILITÀ CONCRETA E MISURABILE.

The environmental factor has become more and more important in NovaBell's planning and investments. The expansion of its plant, its industry 4.0 technologies and its new infrastructures originate from a genuine rethink of the entire industrial process, which sees sustainability as a strategic priority. The company makes an active contribution through a series of real, measurable actions:

- reduction of 500 tons per year in CO₂ emissions
- 7% reduction in energy use
- 99.5% of waste reused in the production cycle
- 8.5% less raw material extraction
- digitalisation 4.0 to innovate processes, products and services
- new road network and resilient infrastructures.

SMART FACTORY: KONKRETE UND MESSBARE NACHHALTIGKEIT.

Durch weitsichtige Planung und Investitionen hat sich NovaBell ambitionierten Umweltzielen verschrieben. Der Ausbau des Werks, die 4.0-Technologien und die neuen Infrastrukturen sind das Ergebnis einer Neukonzeption der gesamten industriellen Fertigung, bei der Nachhaltigkeit strategische Priorität hat. Durch eine Reihe konkreter und messbarer Maßnahmen leistet das Unternehmen einen aktiven Beitrag zum Umweltschutz:

- 500 Tonnen CO₂-Reduzierung pro Jahr
- Verringerung des Energieverbrauchs um 7 %
- 99,5 % der Abfälle aus dem Fertigungsprozess werden wiederverwendet
- 8,5 % weniger Rohstoffabbau
- Digitalisierung 4.0 im Hinblick auf innovative Prozesse, Produkte und Dienstleistungen
- Neues Straßen- und Wegenetz sowie resiliente Infrastrukturen.

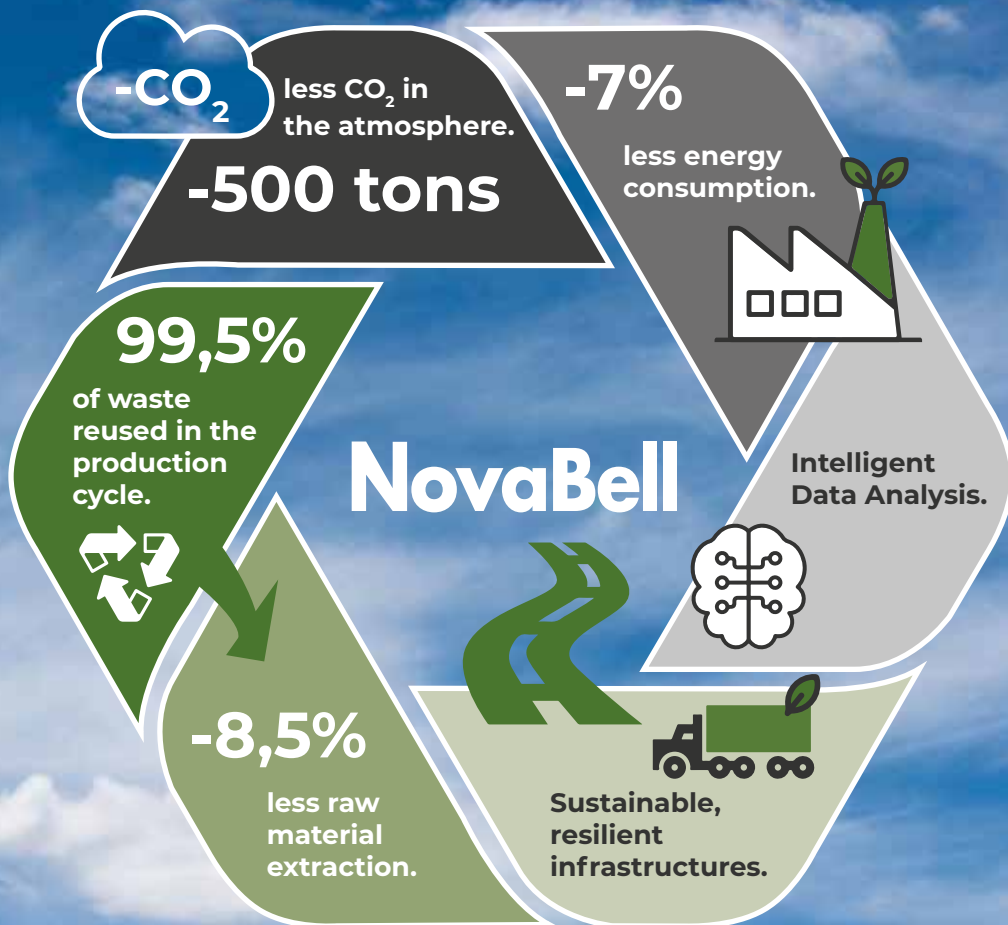

QUALITY AND SUSTAINABLE AND CIRCULAR DEVELOPMENT.



Emission control.
/ Controllo delle emissioni.



Water and energy consumption control.
/ Controllo dei consumi idrici ed energetici.



Internal wastewater recycling.
/ Riciclo interno delle acque reflue.



Innovative technologies.
/ Innovative tecnologie.



Compliance with minimum noise levels.
/ Rispetto dei livelli minimi di rumorosità.



Systematic control and maintenance.
/ Controllo e manutenzione sistematica.



Ongoing employee training.
/ Formazione costante dei dipendenti.

QUALITÀ E SVILUPPO SOSTENIBILE E CIRCOLARE.

Per NovaBell l'economia circolare rappresenta un nuovo paradigma, un sistema che mette al primo posto la riduzione e il controllo degli scarti di lavorazione. L'azienda riutilizza la quasi totalità delle acque reflue e degli scarti di lavorazione e identifica attraverso il marchio "NovaBell Ecosystem" i prodotti che contengono almeno il 40% di materiale riciclato. Il gres porcellanato ha una qualità altissima e un impatto molto contenuto grazie a processi che mettono al primo posto l'ambiente e l'uomo.

NovaBell è un modello di impresa che ha a cuore la sostenibilità sociale, oltre quella ambientale, la sicurezza dei lavoratori e la loro formazione sono una priorità strategica insieme ad una manutenzione puntuale e costante di tutti gli impianti produttivi.

QUALITÉ ET DÉVELOPPEMENT DURABLE ET CIRCULAIRE.

L'économie circulaire représente, pour NovaBell, un nouveau paradigme, un système qui met au premier plan la réduction et le contrôle des déchets de production. L'entreprise réutilise la quasi-totalité des effluents et des déchets de production, et elle identifie avec la marque « NovaBell Ecosystem » les produits avec un contenu recyclé minimum de 40 %. Issu de procédés considérant l'environnement et l'homme comme de première importance, le grès cérame possède une qualité très élevée et exerce un impact très limité.

NovaBell est un modèle d'entreprise qui a à cœur, non seulement la durabilité environnementale, mais aussi la durabilité sociale. En effet, la sécurité des employés et leur formation constituent des priorités stratégiques, et tous les sites de production reçoivent une maintenance régulière et constante.

QUALITY AND SUSTAINABLE AND CIRCULAR DEVELOPMENT.

For NovaBell the circular economy is a new paradigm, a system that prioritises the reduction and control of processing waste. The company reuses almost all wastewater and processing waste and uses its 'NovaBell Ecosystem' label to identify products that contain at least 40% recycled material. Its porcelain stoneware is of outstanding quality and has very low impact thanks to processes that put the environment and people first.

NovaBell adopts a business model built around social as well as environmental sustainability: workers' safety and training are a strategic priority, together with constant, regular maintenance of all production plants.

QUALITÄT, NACHHALTIGE ENTWICKLUNG UND KREISLAUFWIRTSCHAFT.

Für NovaBell verkörpert die Kreislaufwirtschaft ein neues Paradigma, ein System, das die Reduzierung und Kontrolle des Abfallvolumens in den Vordergrund stellt. Angesichts der Wiederverwendung nahezu aller Abwässer und Verarbeitungsausschüsse kennzeichnet das Unternehmen mit dem Markenzeichen „NovaBell Ecosystem“ jene Produkte, die einen Recyclinganteil von mindestens 40 % aufweisen.

Dank Verfahren, die die Umwelt und den Menschen in den Mittelpunkt stellen, zeichnet sich das Feinsteinzeug durch höchste Qualität und sehr geringe Umweltauswirkungen aus.

NovaBell steht für ein Geschäftsmodell mit Fokus auf sozialer und ökologischer Nachhaltigkeit. Dabei haben die Sicherheit und das Training der Mitarbeiter wie auch die fristgerechte und regelmäßige Wartung aller Produktionsanlagen oberste Priorität.

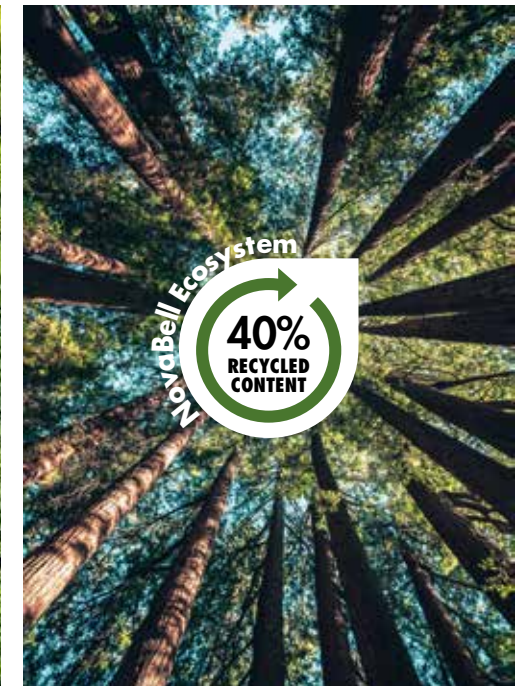

Photo by: Daniela Izozenko - Fot Whalen - Alex Bartha - Casey Horner

OUTDOORS BECOMES A NEW LIVING SPACE.

L'outdoor come nuovo spazio abitativo. / L'outdoor comme nouvel espace habitable. /
Aussenbereich als neuer Wohnraum.



Public
spaces



Residential
spaces



External
facades



Outwalk 20 è la superficie ideale per ogni utilizzo, domestico o pubblico. Per tutti gli spazi outdoor, i camminamenti e le aree piscina NovaBell assicura un'ampia gamma di soluzioni estetiche e performance insuperabili.

Outwalk 20 is the ideal surface for all domestic or public uses. For all outdoor spaces, pavements and swimming pool areas NovaBell guarantees a wide range of aesthetic solutions and unbeatable performance.

Outwalk 20 : la surface idéale pour tout type d'application, domestique ou publique. Pour tous les espaces extérieurs, les cheminements et les zones piscine, NovaBell assure une vaste gamme de solutions esthétiques alliées à des performances inégalées.

Outwalk 20 ist die ideale Oberfläche für alle Anwendungszwecke in Wohn- und Gewerbebauten. NovaBell garantiert für alle Outdoor-Bereiche, Gehwege und Pool-Bereiche ein großes Angebot an optischen Lösungen mit unübertrefflichen Leistungsmerkmalen.

WHATEVER YOUR IDEA OF OUTDOORS.

Qualunque sia la tua idea di outdoor. / Quelle que soit votre conception de l'outdoor. /
Wie auch immer ihr Outdoor-Konzept aussieht.



Terraces



Pools



Gardens



Public spaces

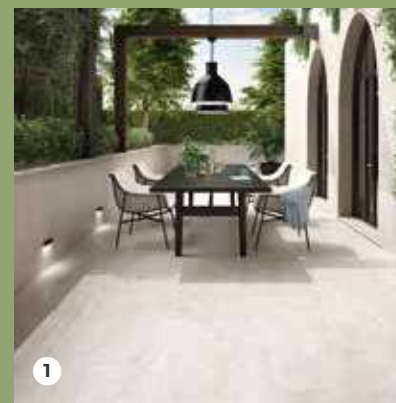

1

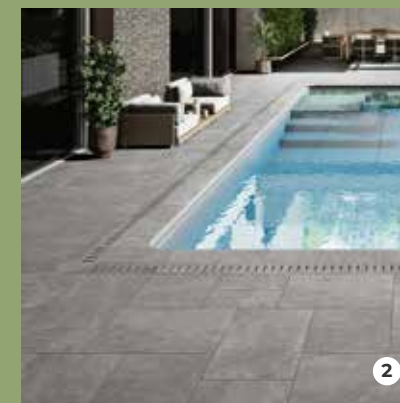

2

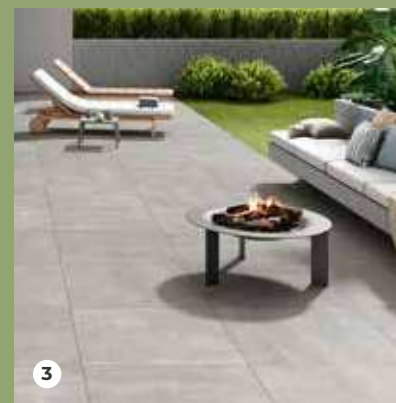

3



4

1_ Terrazze. / Terraces. / Terrasses. / Terrasse.

3_ Giardini. / Gardens. / Jardins. / Gärten.

2_ Piscine. / Pools. / Schwimmbäder.

4_ Spazi pubblici. / Public spaces. /
Espaces publics. / Öffentliche Gebäude.

OUTDOOR PLUS



Facile da posare.
Easy to install.
Facile à poser.
Verlegefreundlich.



Facile da pulire.
Easy to clean.
Facile à nettoyer.
Pflegeleicht.



Non si usura.
Does not wear.
Inusable.
Abriebfest.



Solido e compatto.
Solid and compact.
Solide et compact.
Robust und kompakt.



Antiscivolo.
Anti-slip.
Antidérapant.
Rutschhemmend.



Colori inalterabili.
Colours that never fade.
Couleurs inaltérables.
Farbecht.



Resiste agli acidi.
Acid-resistant.
Résistant aux acides.
Säurebeständig.



Resiste al gelo.
Frostproof.
Résistant au gel.
Frostbeständig.



Resiste al sale.
Resistant to salt.
Résistant au sel.
Salzbeständig.



Ignifugo.
Flame retardant.
Ignifuge.
Feuerhemmend.



Non si macchia.
Does not stain.
Antitache.
Fleckbeständig.



Inattaccabile da muffe e veridrame.
Immune to mould and verdigris.
Résistant aux moisissures et aux Taches de vert-de-gris.
Beständig gegen schimmel- und Grünspanbefall.



High resistance.

Il superamento di tutti i test normativi testimoniano l'impegno costante di NovaBell per garantire un prodotto ultraprestazionale con una resistenza alla flessione, una durezza e una impermeabilità insuperabili.

Per scaricare i certificati e per maggiori informazioni vi invitiamo a consultare il nostro sito:

www.novabell.it

NovaBell's products have passed all regulatory tests, underlining its unwavering commitment to guaranteeing ultra high-performance solutions with unparalleled bending strength, toughness and impermeableness.

To download the certificates and for more information visit our website:

www.novabell.it

Sa réussite à tous les tests réglementaires témoigne de l'engagement constant de NovaBell à garantir un produit ultra-performant doté d'une résistance à la flexion, d'une dureté et d'une imperméabilité inégalées.

Pour télécharger les certificats et pour de plus amples informations, nous vous invitons à consulter notre site :

www.novabell.it

Die Überwindung aller gesetzlich vorgesehenen Tests ist beispielhaft für das kontinuierliche Engagement zur Gewährleistung eines extrem leistungsstarken Produkts mit einer einzigartigen Biegefestigkeit, Härte und Wasserdichte. Zum Herunterladen der Zertifikate und für weitere Informationen konsultieren Sie bitte unsere Website:

www.novabell.it

OUTDOOR TEST AND PERFORMANCE



Carico di rottura / Breaking strength
Charge de rupture / Bruchkraft
ISO 10545 - 4: 2014

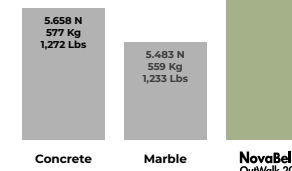

Durezza / Toughness
Dureté / Härte
UNI EN 101

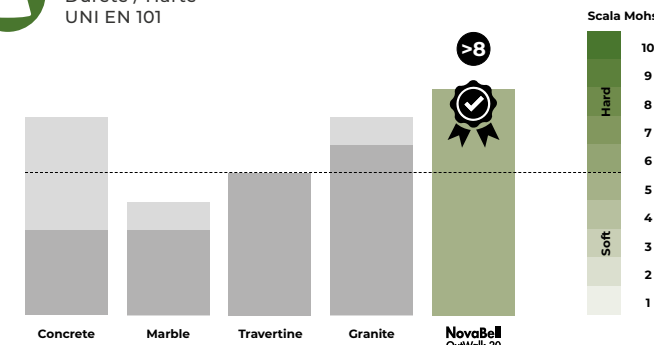

Resistenza alle macchie / Resistance to staining
Résistance aux taches / Fleckenbeständigkeit
ISO 10545 - 14



Pulizia dopo le 24 h / Cleaning after 24 h /
Nettoyage après 24 heures /
Reinigung nach 24 Std.

Cleaning Method	Stain Type
Pulito solo con acqua / Cleaned with water only / Nettoyé uniquement avec de l'eau / Reinigung nur mit Wasser	Olio Leggero / Light oil / Huile légère / Leichtes Öl / Huile d'olive / Olive oil / Iodio / Iodine / Ketchup / Ketchup / Caffè / Coffee / Café / Kaffee
	Salsa di soia / Soy sauce / Sauce de soja / Sojasauc

OUTDOOR COMPLETE PROJECT

Ogni accessorio **NovaBell** è stato pensato per coordinarsi alle pavimentazioni e completare **aree piscina, scale, muretti, ogni tipo di camminamento e tutte le esigenze dell'outdoor living.**

Every accessory is designed to match the floor coverings and pavings and to complete **swimming-pool areas, staircases, low walls, all kinds of paths and all the needs of outdoor living.**

Chaque accessoire a été mis au point pour se coordonner au revêtement de sol et pour compléter les zones de piscine, **les escaliers, les murets, tout type de cheminement et tous les cadres de vie en plein air.**

Alle Einrichtungsaccessoires sind auf die Bodenbeläge abgestimmt. Sie runden die Gestaltungskonzepte für **Poolbereiche, Treppen, halbhohle Mauern und Gehwegen** ab und werden **sämtlichen Anforderungen des Outdoor-Livings** gerecht.

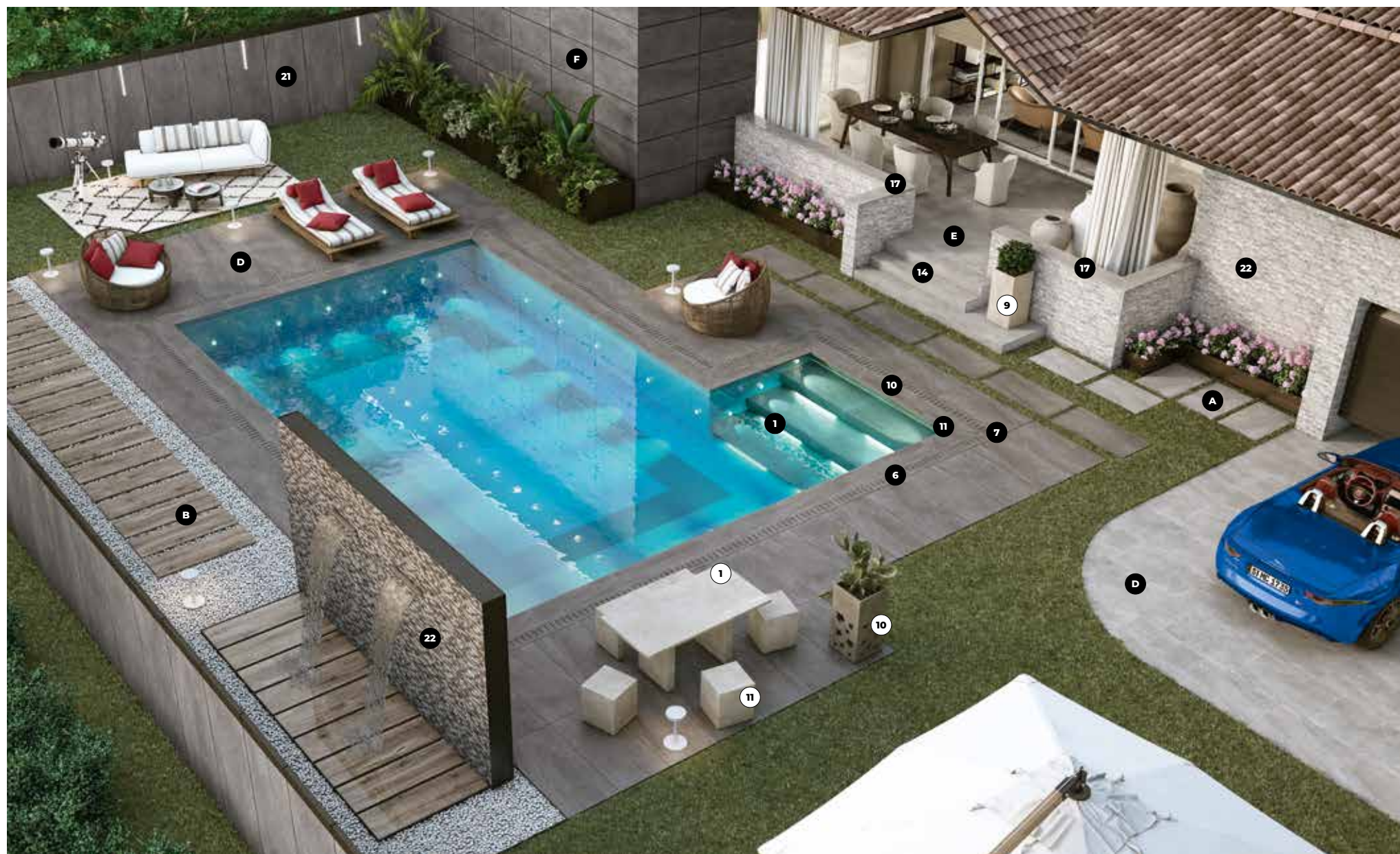

- A** Posa a secco - Su erba
Dry laying - On grass
- B** Posa a secco - Su ghiaia
Dry laying - On gravel
- D** Posa a colla
Laying with adhesives
- E** Posa rialzata per esterni
Outdoor raised pavings
- F** Posa pareti ventilate
Laying facades ventilate
- 1** Gradino Monografico
- 10** Toro Gradino
- 11** Toro Angolo SX / DX
- 6** Griglia
- 7** Angolo Griglia SX / DX
- 14** Gradino Elle Maxi
- 17** Copertina
- 22** BRICKUP
- 21** Palizzate Fence
- 1** Tavolo
Table
- 9** Fioriera Alta
Flower Tub
- 10** Fioriera Alta Intarsi
Flower Tub
- 11** Cubo Seduta
Seat Cube

6 LAYING OPTIONS

6 sistemi che assicurano versatilità e soluzioni personalizzate, dalla posa tradizionale su massetto per pavimentazioni carrabili fino alla posa sopraelevata ispezionabile, che consente l'alloggio dell'impiantistica.

6 systems that guarantee versatility and personalised solutions, from traditional installation on screed for drive-over pavements through to installation as easily-inspected raised paving, with space to house the engineering system.

6 systèmes qui assurent polyvalence et solutions personnalisées, depuis la pose traditionnelle sur chape pour sols carrossables jusqu'à la pose surélevée avec vide technique qui permet d'accueillir les installations.

6 Systeme, die Vielseitigkeit und personalisierte Lösungen garantieren - angefangen vom herkömmlichen Verlegesystem auf Estrich für befahrbare Bodenfliesen bis hin zur Verlegung auf inspizierbaren Stelzlagern.



Giardini e vialetti
Gardens & paths
Jardins et allées
Gärten & wege



Terrazze e balconi
Terraces & balconies
Terrasses et balcons
Terrassen & balkone



Piscine e spiaggia
Pools & beach
Piscine & plage
Schwimmbäder & strände



Carrabili e pedonali
Driveways & promenades
Surfaces carrossables & piétonnes
Fahr- & gehwege



Posa a secco / Dry laying

Pose à sec / Trockene verlegung



A Su erba / On grass

Sur l'herbe / Auf Gras

Installazione semplice e rapida
Riposizionabile
Riutilizzabile
Quick, easy installation
Can be repositioned
Can be reused
Simple et rapide à poser
Repositionnable
Réutilisable
Einfache und schnelle Verlegung
Umverlegbar
Wiederverwendbar



B Su ghiaia / On gravel

Sur le gravier / Auf kies

Facile da posare
Riposizionabile
Ottimo drenaggio
Anche per terrazze e roof-garden
Easy to install
Can be repositioned
Excellent drainage
Also for patios and roof-gardens
Facile à poser
Repositionnable
Excellent drainage
Également pour terrasses et terrasses-jardins sur le toit
Verlegefreundlich
Umverlegbar
Optimale Drainage
Auch für Terrassen und Dachgärten



C Su sabbia / On sand

Sur le sable / Auf sand

Installazione semplice e veloce
Riutilizzabile
Riposizionabile
Resiste alla salsedine e al sole
Swift, easy installation
Can be reused
Can be repositioned
Resistant to salt spray and sunlight
Simple et rapide à poser
Réutilisable
Repositionnable
Résistant au sel et au soleil
Einfache und schnelle Verlegung
Wiederverwendbar
Umverlegbar
Beständig gegen Salzwasser und Sonnenlicht



D Posa a colla / Laying with adhesives

Pose collée / Verlegung im Kleberbett

Carrabile con auto
Grande formato, estetica top
Impermeabile a benzina-olio
Drive-over for cars
Large size, unbeatable appearance
Impermeable to petrol-oil
Carrossable
Grand format, esthétique supérieure
Imperméable à l'essence et à l'huile
Befahrbar
Trendiges Großformat
Undurchlässig gegenüber Benzin und Öl



E Posa rialzata per esterni / Outdoor raised pavings

Plancher surélevé extérieur / Aufgestellte Verlegung für aussenbereiches

Ispezionabile
Drenante
Alloggia tubature e cavi
Compensa superfici non livellate
Inspectable
Effective drainage
Accommodates pipes and wiring
Compensates for uneven surfaces
Contrôlable
Drainant
Logement des tuyaux et câbles
Compensation des dénivélés
Inspektionierbar
Wasserabführend
Aufnahme von Rohrleitungen und Kabeln
Ausgleich von unebenen Flächen



F Posa pareti ventilate Laying facades ventilate

Pose façades ventilées / Verlegung Vorgehängte hinterlüftete Fassaden

Ispezionabile
Risparmio energetico
Abbattimento acustico
Protezione dall'acqua e dal ghiaccio
Inspectable
Energy savings
Reduced noise pollution
Protection from water and ice
Contrôlable
Économies d'énergie
Réduction du bruit
Protection contre l'eau et la glace
Inspektionierbar
Energieeinsparung
Schallschutz
Schutz vor Wasser und Eis

MULTISIZE PRONTO ALL'USO

NovaBell si impegna costantemente nel servizio di assistenza al cliente. Per gli articoli **MULTIFORMATO**, le proporzioni di posa, sono state calcolate e organizzate in pallet pronti all'uso. Questo servizio regala velocità di installazione e risparmio di tempo.

MULTISIZE READY FOR USE. NovaBell provides constant customer service and assistance. For **MULTIPLE-SIZE** modules, the installation proportions are calculated and organized in ready-to-use pallets. This service speeds up the installation process and saves time.

TAILLES MULTIPLES PRÊTES À L'EMPLOI. NovaBell est constamment engagée au service et l'assistance de la clientèle. Pour les articles **MULTIFORMAT**, les proportions de pose ont été calculées et organisées en palettes prêtes à l'emploi. Ce service permet rapidité d'installation et gain de temps.

GERBRAUCHSFERTIGE MULTISIZE-FORMATE. NovaBell steht konstant im Dienst des Kunden und bietet in diesem Sinn entsprechende Leistungen. Hinsichtlich der **MEHRFORMATIGEN** Artikel werden die Verlegeproportionen passend berechnet und auf verarbeitungsfertigen Paletten organisiert. Dieser Service gewährleistet eine rasche Verlegung und Zeitersparnis.

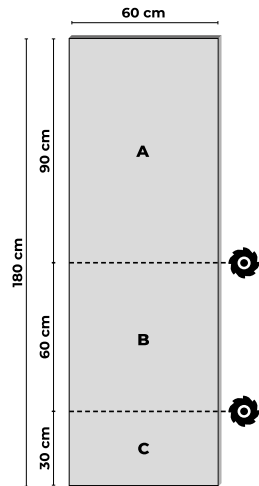

Colori disponibili / Colours available
Couleurs disponibles / Verfügbare Farben



PIETRA / STONE / PIERRE / STEIN													
THERMAE			ASPEN			SOVEREIGN			STONE BOX				
Storm	Honey	Caramel	Oxide	Snow	Rock Grey	Basalt	Beige	Antracite	Blue Stone	Peaked Brown	Peaked Grey	Peaked Basalt	Urbe White Grey
LOUNGE				ALLBLACK			NORGESTONE			LUMIÈRE			
Earth	Pearl	Steel	Shadow	Beige	Grigio	Antracite	Taupe	Light Grey	Dark Grey	Sabbia	Ambra	Genere	

Laying scheme Multisize 1

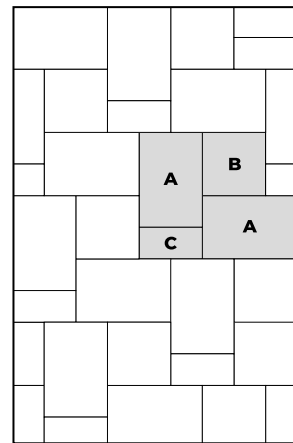

A 60x90 = 66,67%

Laying scheme Multisize 2 (random)

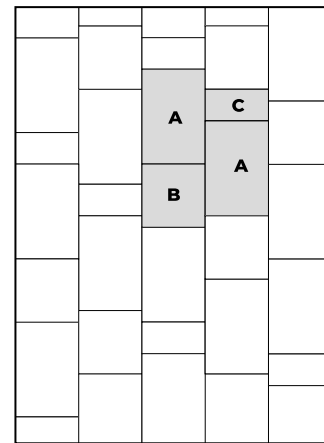

B 60x60 = 22,22%

C 30x60 = 11,11%

Spacer suggested > 4 mm

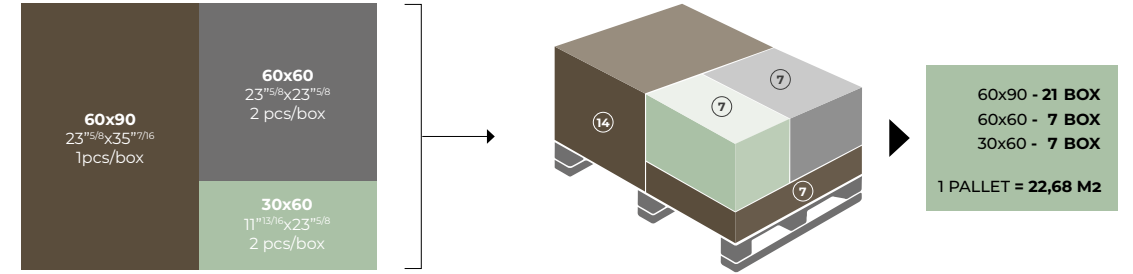

MULTISIZE PLUS



Economia sul costo dei trasporti e sullo spazio in magazzino
• 1 Sola paletta con tutti i formati

Optimization of transportation costs and warehouse space
• 1 Single pallet with all sizes on it

Économie sur le coût des transports et sur l'emplacement dans le stock
• 1 Palette simple toutes tailles

Wirtschaftliche Transportkosten und Lagerhaltung
• Nur 1 Palette mit allen Formaten

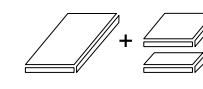

Tutto il materiale viene utilizzato non ci sono rimanenze in magazzino

All the material is used there are no left over

Tout le matériel est utilisé il n'y a pas d'inventaire dans l'entrepôt

Das gesamte Material wird verwendet. Keine Vorratshaltung

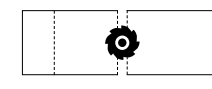

Tutti i formati sono ricavati dalla lastra 60x180x2 cm
• Non ci sono differenze di tono
• Non ci sono differenze di superficie al tatto

Every size is obtained from the 60x180x2 cm slab
• There are no shade differences
• There are no differences of surface to the touch

Toutes les tailles sont obtenues à partir de la dalle 60x180x2 cm
• Il n'y a aucune différence de nuance
• Il n'y a aucune différence de surface au toucher

Alle Formate werden aus der Platte im Format 60x180x2 cm gefertigt
• Es gibt keine Farbtonabweichungen
• Die Oberflächen weisen keine haptischen Unterschiede auf



La paletta è stata studiata in modo che le scatole vengano prelevate da un solo operatore
• La paletta rimane sempre stabile perché le scatole sono appoggiate in orizzontale

The pallet has been studied so that the boxes can be taken from a single operator
• The pallet is always stable because the boxes are laid horizontally

La palette a été étudiée afin que les boîtes sont manipulées par un opérateur unique
• La palette reste toujours stable parce que les boîtes sont placés en horizontal

Die Palette wurde so entwickelt, dass die Kartons von einem einzigen Arbeiter entnommen werden können
• Die Palette bewahrt stets ihre Stabilität, da die Kartons waagrecht angeordnet sind



GLI SVANTAGGI DEL MULTIFORMATO A PALETTE SINGOLE / DISADVANTAGES OF THE MULTISIZE PATTERN WHEN EACH SIZE IS ON ITS OWN PALLET / DÉSAVANTAGES DES PALETTES SIMPLES EN MULTIFORMAT / DIE NACHTEILE DES MULTIFORMATS MIT EINZELPALETTEN

• I toni e la mano superficiale possono essere diversi.
• Nell'eseguire un lavoro in cantiere occorre fare i conti di quante scatole prelevare da ogni singola paletta.
• Spesso le scatole sono disposte sia in verticale che orizzontale e quindi occorrono due operatori.
• I formati hanno percentuali diverse di utilizzo, quindi rimangono più scarti.

• Les nuances et la main de la surface peuvent être différents.
• Pour réaliser des travaux sur le chantier, il est nécessaire calculer combien de boîtes prendre par chaque format sur les différentes palettes.
• Souvent, les boîtes sont fournies à la fois en verticale et horizontale vous avez besoin de deux opérateurs.
• Les formats ont des pourcentages différents d'utilisation donc il y a plus de déchets.

• Shades and touch of the surface can be different.
• When installing material you need to count how many boxes you will need from each pallet.
• Often the boxes are laid both vertically and horizontally on the pallet therefore you need two operators.
• Each size has different percentage of use, therefore there will be leftovers.

• Farbton und Haptik der Oberflächen können unterschiedlich aufweisen.
• Bei der Ausführung einer Arbeit auf der Baustelle muss berechnet werden, wie viele Kartons von jeder einzelnen Palette zu entnehmen sind.
• Häufig sind die Kartons sowohl senkrecht als auch waagrecht angeordnet, weswegen zwei Arbeiter zur Entnahme erforderlich sind.
• Die Formate werden prozentual unterschiedlich genutzt, weshalb mehr Ausschuss anfällt.

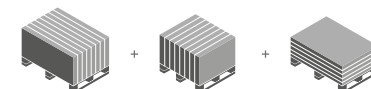

ACCESSORIES SWIMMING POOL

R11 A+B+C



Bordo piscina
Pool copings
Bord de piscine
Beckenrand

GRADINO MONOGRAFICO 1

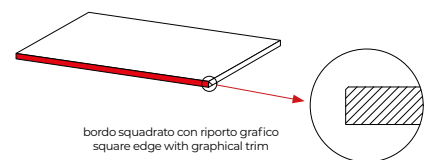

bordo squadrato con riporto grafico
square edge with graphical trim

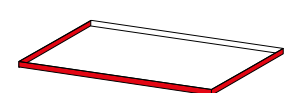
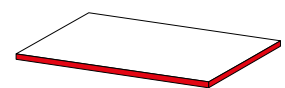

ANGOLO MONOGRAFICO 2

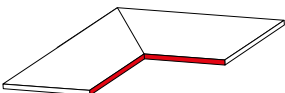

Sizes

33x180

33x120



1 bordo squadrato con riporto grafico

1 square edge with graphical trim
1 nez carré avec retour graphique
1 eckige Kante mit Umleimer in Plattenoptik

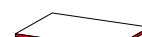

2 bordi squadrati con riporto grafico

2 square edges with graphical trim
2 nez carrés avec retour graphique
2 eckige Kanten mit Umleimer in Plattenoptik



3 bordi squadrati con riporto grafico

3 square edges with graphical trim
3 nez carrés avec retour graphique
3 eckige Kanten mit Umleimer in Plattenoptik



TORO GRADINO 8

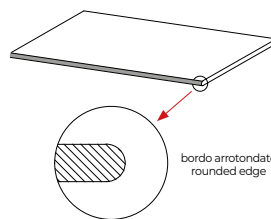

bordo arrotondato
rounded edge

TORO ANGOLO DX/SX 9

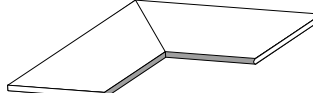

BORDO ANTIDERAPANT 10

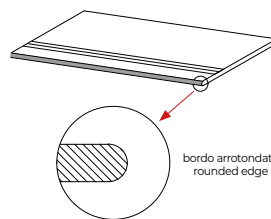

bordo arrotondato
rounded edge

BORDO ANTIDERAPANT ANGOLO DX/SX 11

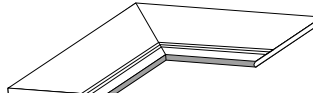

Sizes

30x180

30x120

40x120

32x120

30x90

40x80

30x60



GRADINO ELLE 3

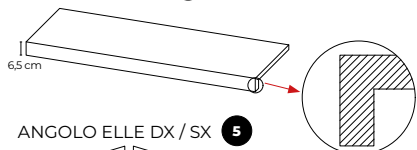

6,5 cm

ANGOLO ELLE DX / SX 5



6,5 cm

ANGOLO ELLE 4



6,5 cm

Sizes

30x180x6,5

30x120x6,5

30x100x6,5

30x90x6,5

30x80x6,5

30x60x6,5

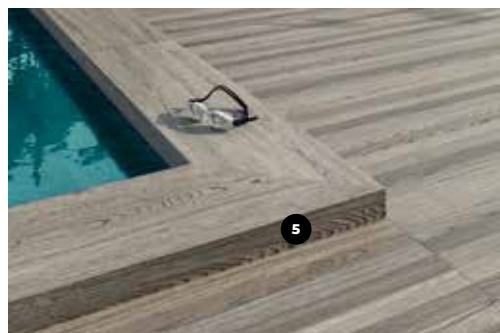

GRADINO COSTA RETTA 12

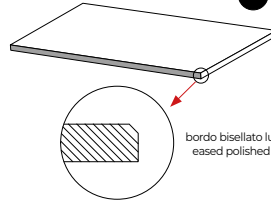

bordo bisellato lucidato
eased polished edge

Sizes

32x120

40x80

30x60

BORDO CURVILINEO O COSTA RETTA 13

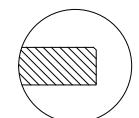

bordo squadrato lucidato
square polished edge

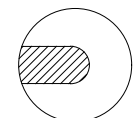

bordo arrotondato
rounded edge

Sizes

100x100

80x80

60x60



GRIGLIA 6

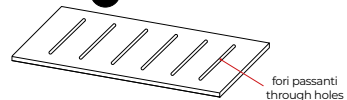

fori passanti
through holes



TECHNICAL
SIZES

Sizes

20x80

20x60

20x50

20x45

15x60

ANGOLO GRIGLIA DX / SX 7

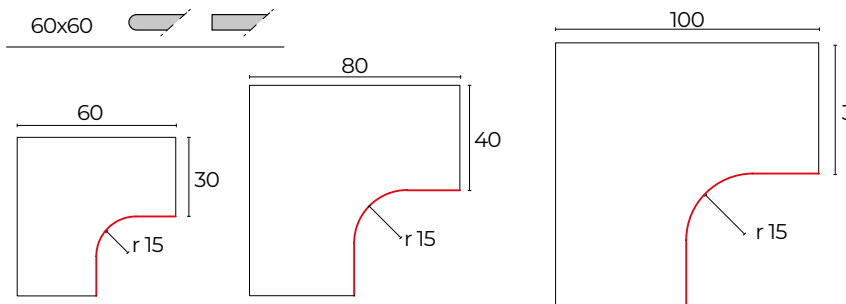
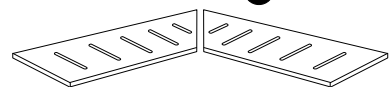

ACCESSORIES STAIRS

I gradini con larghezza fino a 180 cm sono perfezionati in ogni dettaglio e possiedono vantaggi impareggiabili: completano le pavimentazioni facilitando la messa in opera sul massetto, sono coordinati al resto delle superfici e le loro dimensioni corrispondono agli standard progettuali.

Steps up to 180 cm wide are perfected in every detail and offer incomparable advantages: they complete the flooring, facilitating installation on screed, they are coordinated with the rest of the surfaces and their dimensions correspond to design standards.

Les marches jusqu'à 180 cm de large sont peaufinées dans les moindres détails et comportent des avantages sans pareils : elles complètent les revêtements de sol en simplifiant la pose sur chape, elles sont coordonnées au reste des surfaces et leurs dimensions sont conformes aux standards de la conception.



info pag. 102

Die Stufen mit einer Breite von 180 cm sind bis ins kleinste Detail durchdacht und besitzen außergewöhnliche Vorteile: Sie bilden den Abschluss von Bodenbelägen und erleichtern den Einbau auf dem Estrich, sie sind auf die übrigen Oberflächen abgestimmt und ihre Abmessungen entsprechen den Planungsstandards.

LARGE CUBE STEP

NovaBell arricchisce l'offerta di accessori per esterno. La nuova linea di lastre per gradini sui formati 100x100 x8h e 35x120x15h è stata studiata per realizzare scale con volumi ceramici in gres porcellanato 2 cm già assemblati, facili e veloci da montare, in continuità con la pavimentazione esterna.

NovaBell has expanded its range of outdoor accessories. The new line of slabs for steps in sizes 100x100x8h and 35x120x15h has been designed to create stairs with pre-assembled 2 cm porcelain stoneware ceramic volumes that are easy and quick to assemble, seamlessly joining outdoor paving.

NovaBell étouffe sa gamme d'accessoires pour extérieur. Disponible dans les formats 100x100x8h et 35x120x15h, la nouvelle collection de marches a été mise au point pour aménager des escaliers en grès cérame à l'aide de volumes céramiques de 2 cm pré-assemblés, simples et rapides à monter, en continuité visuelle avec le revêtement de sol extérieur.



R11 A+B+C

NovaBell stocka das Zubehörangebot für Außenbereiche auf. Die neue Plattenserie für Treppenstufen in den Formaten 100x100x8h und 35x120x15h ist eigens für die Erstellung von Treppen mit bereits zusammengesetzten Feinsteinzeug-Keramikelementen von 2 cm Stärke ausgelegt; passend zum Outdoor-Bodenbelag lassen sich die Elemente schnell und problemlos einbauen.

R11 A+B+C

1 Gradino monografico



2 cm I



8 Toro Gradino



2 cm I



3 Gradino Elle



6,5 cm I

4 Angolo Elle



14 Gradino Elle Maxi



17 cm I

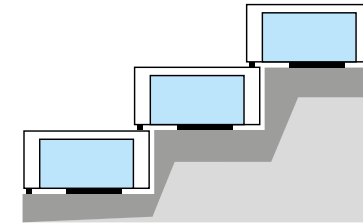
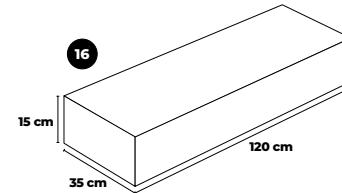
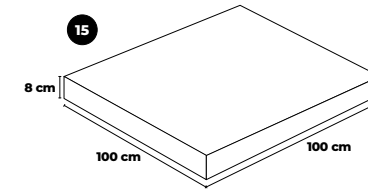

15 Gradone Cubotto 100x100x8 cm

- _Lounge
- _Thermae
- _Aspen
- _Oxy

16 Gradone Cubotto 35x120x15 cm

- _Lounge
- _Thermae
- _Aspen
- _Davos
- _Stone Box
- _Norgestone
- _Open
- _Artwood
- _Eiche
- _My Space
- _Time Design

15 Gradone Cubotto 100x100x8 cm
23¹⁵/₈ x 70⁷/₈ x 3¹/₈

16 Gradone Cubotto 35x120x15 cm
13³/₄ x 47¹/₄ x 5⁷/₈



ACCESSORIES - SLAB FOR STEPS

Lastre per gradini. Novabell offre un'ampia gamma di Lastre Pre-Finite in 20MM di varie dimensioni per realizzare in opera gradini e scale su misura.

Slab for steps. NovaBell offers a wide range of 20mm pre-finished slabs in various sizes of create customized steps and stairs on site.

Dalles pour marches. Novabell offre une large gamme de dalles préfini en 20mm de différentes dimensions pour réaliser sur place marches et et escaliers sur mesure.

Stufenplatten. NovaBell bietet ein großes Angebot an vorgefertigten 20 mm starken Platten in verschiedenen Größen für die Herstellung von Stufen und maßgeschneiderte Treppe.

Size Weight	1	6	3	14
	Gradino Monografico	Gradino Toro	Gradino Elle	Gradino Elle Maxi
60x180x2 working size Kg 45	 60x180x2 real size	 60x180x2 real size	 60x180x6,5 real size	 42x180x17 real size
	cod. GR 180 MO	cod. GR 180 TO	cod. GR 180 EL	cod. GR 180 MX
60x120x2 working size Kg 32	 60x120x2 real size	 60x120x2 real size	 60x120x6,5 real size	 42x120x17 real size
	cod. GR 120 MO	cod. GR 120 TO	cod. GR 120 EL	cod. GR120 MX
60x90x2 working size Kg 23,5	 60x90x2 real size	 60x90x2 real size	 60x90x6,5 real size	 42x90x17 real size
	cod. GR 90 MO	cod. GR 90 MO	cod. GR 90 EL	cod. GR 90 MX
100x100x2 working size Kg 41,5	 100x100x2 real size	 100x100x2 real size	 100x100x6,5 real size	 82x100x17 real size
	cod. GR 100 MO	cod. GR 100 TO	cod. GR 100 EL	cod. GR 100 MX

! Ordine minimo pz. 10 / Minimum order 10 pcs / Minimum 10 pcs / Mindestbestellmenge 10 stk

i info gamma prodotti e finiture pagina 104 / info on product range and finishes page 104 / info gamme produits et finitions page 104 / Information zu Produktangebot und Oberflächenhaptik S 104

FURNISHING & ACCESSORIES

Le lastre **OutWalk 20** possono essere lavorate su richiesta per la progettazione di complementi d'arredo in totale coordinazione con il resto delle superfici.

OutWalk 20 slabs can be custom designed to create furnishings perfectly in keeping with the rest of the surfaces.

Les dalles **OutWalk 20** peuvent être façonnées sur demande pour la conception d'accessoires d'ameublement en coordination totale avec le reste des surfaces.

Auf Anfrage ist die Bearbeitung der Platten **OutWalk 20** möglich, wenn Einrichtungsaccessoires im einheitlichen Look mit den Flächenbelägen gewünscht werden.

	PIETRA / STONE PIERRE / STEIN										LEGNO / WOOD BOIS / HOLZ		METALLO & CEMENTO METAL & CONCRET METALL & BETON		
	ALLBLACK	ASPEN	DAVOS	DOLOMITA	LANDSTONE	LOUNGE	MAXIMA	NORCESTONE	THERMAE	ARTWOOD	EICHE	NORDIC WOOD	FORGE	OPEN	OPY
R11 A+B+C															
① TAV2CM1 TAVOLO 160x80x75h	-	-	-	-	-	•	-	-	-	-	-	-	•	•	•
② TAV2CM2 TAVOLO 120x80x75h	•	•	•	•	•	•	•	•	•	•	•	-	-	-	-
③ PANC2CM8 PANCA CHIUSA 80x40x40h	-	-	-	-	-	-	-	-	-	-	-	-	•	•	•
④ PANC2CM12 PANCA CHIUSA 120x40x40h	•	•	•	•	•	•	•	•	•	•	•	-	-	-	-
⑤ PANK2CM2 PANCA APERTA 80x40x45h	-	-	-	-	-	-	-	-	-	-	-	-	•	•	•
⑥ PANK2CM1 PANCA APERTA 120x40x45h	•	•	•	•	•	•	•	•	•	•	•	-	-	-	-
⑦ FIO2CM3 FIORIERA BASSA 80x40x40h	-	-	-	-	-	-	-	-	-	-	-	-	-	-	-
⑧ FIO2CM1 FIORIERA BASSA 120x40x40h	•	•	•	•	•	•	•	•	•	•	•	-	-	-	-
⑨ FIO2CM2 FIORIERA ALTA 40x40x80h	•	•	•	•	•	•	•	•	•	•	•	-	-	-	-
⑩ FIO2CM25 FIORIERA INTARSI ALTA 40x40x80h	•	•	•	•	•	•	•	•	•	•	•	-	-	-	-
⑪ CUB2CM1 CUBO 40x40x45h	•	•	•	•	•	•	•	•	•	•	•	-	-	-	-
⑫ CUB2CM15 CUBO INTARSI 40x40x45h	•	•	•	•	•	•	•	•	•	•	•	-	-	-	-
⑬ OMBRI PORTA OMBRELLI 40x40x40h	•	•	•	•	•	•	•	•	•	•	•	-	-	-	-

PANCA APERTA / Bench / Banc / Bank

⑨ **FIORIERA ALTA** 40x40x80h
Codice: FIO2CM2

⑩ **FIORIERA INTARSI ALTA** 40x40x80h
Codice: FIO2CM25

CUBI SEDUTA / Seat cubes / Sièges cubes / Sitzwürfel

⑪ **CUBO** 40x40x45h
Codice: CUB2CM1

⑫ **CUBO INTARSI** 40x40x45h
Codice: CUB2CM15

⑬ **PORTAOMBRELLI** 40x40x40h
Codice: OMBRI



COPINGS / COUVERTINES

Attraverso il vasto assortimento di pezzi speciali **OutWalk 20** risolve tutti i dettagli di posa completando con precisione outdoor e gardening.

Thanks to its wide range of special trims **OutWalk 20** takes care of all installation details completing outdoor spaces and gardens with precision solutions.

Grâce au vaste assortiment de pièces spéciales, **OutWalk 20** résout tous les détails de pose, en épousant idéalement extérieur et jardin.

Dank der großen Auswahl an Formteilen wird **OutWalk 20** allen Verlegeerfordernissen gerecht und ermöglicht präzise Flächengestaltungen im Außen- und Gartenbereich.

R11 A+B+C



Colori disponibili / Colours available Couleurs disponibles / Verfügbare Farben

PIETRA / STONE / PIERRE / STEIN										
COPERTINA 30x120x2										
LOUNGE		ASPEN			NORGESTONE			THERMAE		
Steel LNG C232	Shadow LNG G972	Sand Moon APN C402	Rock Grey APN G122	Basalt APN G212	Taupe NST G412	Dark Grey NST G212	Slate NST G912	Caramel TRM C312	Storm TRM C212	
COPERTINA 30x60x2										
LOUNGE		ASPEN			NORGESTONE			THERMAE		SOVEREIGN
Steel LNG C263	Shadow LNG G990	Sand Moon APN C460	Rock Grey APN G160	Basalt APN G263	Taupe NST C460	Dark Grey NST G260	Slate NST G960	Caramel TRM C363	Storm TRM C263	Beige SVN C460
CAPITELLO 40x40x2										
LOUNGE		ASPEN			NORGESTONE			THERMAE		SOVEREIGN
Steel LNG CA26	Shadow LNG CA96	Sand Moon APN CA46	Rock Grey APN CA16	Basalt APN C326	Taupe NST CA46	Dark Grey NST CA26	Slate NST CA96	Caramel TRM C363	Storm TRM C263	Beige SVN CA46

- 17 Copertina 30x60x2 cm 11¹³/₁₆x23¹⁵/₈x3³/₄" 02/495
- 18 Copertina 30x120x2 cm 11¹³/₁₆x47¹/₄x3³/₄" 01/645
- 19 Capitello 40x40x2 cm 15³/₄x15³/₄x3³/₄" 02/656

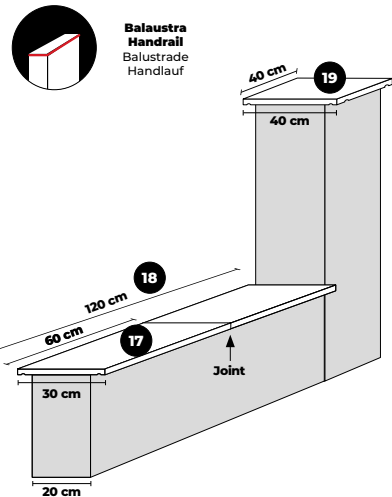
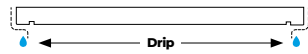

Balaustra Handrail Balustrade Handlauf

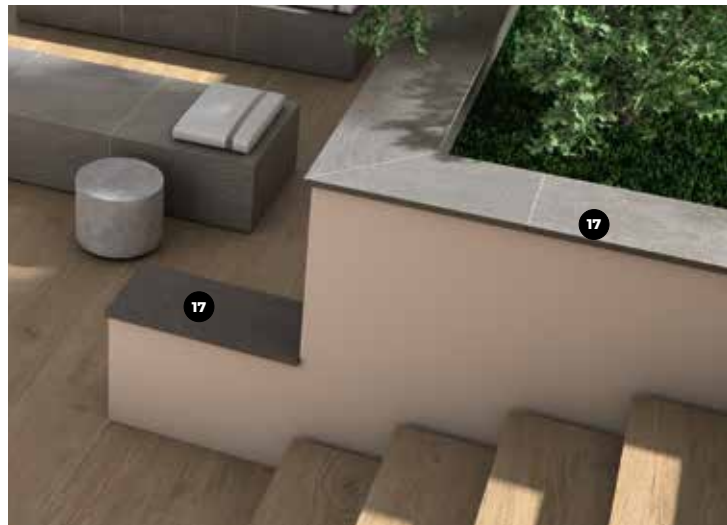

FENCE & PALISSADES



Le palizzate rappresentano una soluzione moderna e innovativa per delimitare qualsiasi area esterna. NovaBell propone una ampia gamma di prodotti in gres porcellanato ad effetto legno ed effetto pietra, costituiti da lastre accoppiate di spessore 20 MM, anche in continuità con la pavimentazione esterna.

Fence are a modern and innovative solution for enclosing any outdoor area. NovaBell offers a wide range of porcelain stoneware products with a wood and stone effect, consisting of 20 mm-thick laminated slabs, including a seamless solution with outdoor paving.

Les palissades constituent une solution moderne et avant-gardiste pour délimiter n'importe quel espace extérieur. NovaBell propose une grande variété de produits en grès cérame effet bois et effet pierre, composés de dalles contrecollées de 20 mm d'épaisseur, cette fois aussi en continuité visuelle avec le revêtement de sol extérieur.

Die Palisaden repräsentieren eine moderne und innovative Lösung zur Begrenzung jeder beliebigen Fläche im Außenbereich. NovaBell verfügt über ein umfassendes Angebot an Feinsteinzeugprodukten in Holz- und Natursteinoptik mit zusammengesetzten Platten von 20 mm Stärke, die auch passend zum Outdoor-Belag ausgewählt werden können.

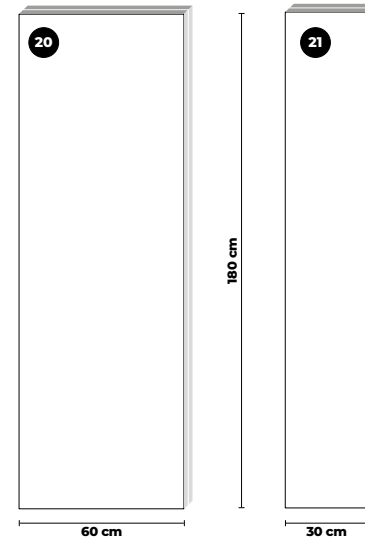

Colori disponibili / Colours available Couleurs disponibles / Verfügbare Farben

LEGNO / WOOD / BOIS / HOLZ										
30x180x2										
NORDIC WOOD			EICHE			ARTWOOD				
Blonde NDW 318P	Walnut NDW 518P	Pepper NDW 718P	Landhaus ECH 418P	Natur ECH 318P	Scottish ECH 518P	Alpin ECH 818P	Timber ECH 618P	Honey AWD 418P	Milk AWD 318P	Clay AWD 218P
PIETRA / STONE / PIERRE / STEIN										
60x180x2										
ASPEN					NORGESTONE					
Oxide APN 718P	Snow APN 818P	Rock Grey APN 718P	Basalt APN 218P	Light Grey NST 718P	Dark Grey NST 218P					

- 20 Palizzata 60x180x2 cm 23⁵/₈x70⁷/₈x3³/₄" 11/1
- 21 Palizzata 30x180x2 cm 11¹³/₁₆x70⁷/₈x3³/₄" 11/1

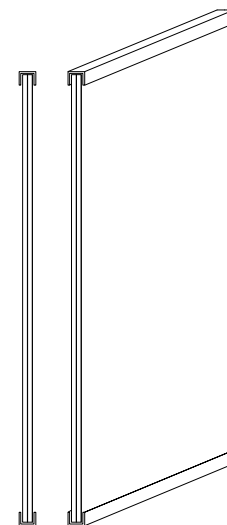

ACCESSORIES BRICKUP

BRICKUP è il progetto di rivestimenti tridimensionali che unisce il design delle materie naturali e tutta la praticità del gres porcellanato NovaBell.

BRICKUP is the three-dimensional covering project that combines the look of natural materials with all the convenience of NovaBell porcelain stoneware.

BRICKUP est le projet de carreaux muraux tridimensionnels conciliant le look des matières naturelles avec l'utilité pratique du gres cérame NovaBell.

BRICKUP ist das Konzept für dreidimensionale Wandbeläge, das ein von natürlichen Materialien inspiriertes Design mit der hohen Funktionalität des Feinsteinzeugs von NovaBell vereint.

R11 A+B+C

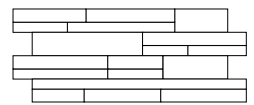

22 Ocean 16x40 cm
6^{5/16}x15^{3/4} 15
1035



23 Breccia 16x40 cm
6^{5/16}x15^{3/4} 14
1035



24 Oldwall 16x42 cm
6^{5/16}x16^{9/16} 14
1035

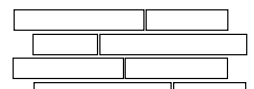

25 New York 16x40 cm
6^{5/16}x15^{3/4} 15
1040

Angolo / Corner / Angle / Winkel



Available in Ocean and New York

Spessore / Thickness / Epaisseur / Stärke

Min. 7 mm Max 9 mm



BKP 467 New York Sand



BKP 667 New York Red Classic



BKP 567 New York Red Brown



BKP 914 Ocean Travertino Storm



BKP 314 Ocean Travertino Honey



BKP 614 Ocean Travertino Mix



BKP 014 Ocean Quarzite Mix



BKP 464 Oldwall Beige



BKP 664 Oldwall Multicolor



BKP 164 Oldwall Grey



BKP 867 New York White



BKP 167 New York Grey



BKP 267 New York Smoke



BKP 814 Ocean White Mix



BKP 114 Ocean Grey



BKP 214 Ocean Ardesia



BKP 414 Ocean Beige



BKP 140 Breccia Grigio



BKP 240 Breccia Antracite



BKP 640 Breccia Rock Mix

Utilizzo / Intended use / Possibilités d'usage / Anwendungsbereiche



Rivestimento parete
Wall coverings
Revêtement mural
Wandverkleidung



Abitazioni residenziali
Residential spaces
Habitations résidentielles
Wohnräume



Spazi pubblici
Public spaces
Espaces publics
Öffentliche Gebäude



Zone umide
Wet areas
Zone humides
Feuchte Bereiche



Muri interni / Muri esterni
wall coverings / external coverings
Murs intérieurs / Mur extérieurs
Innenwände / Außenverkleidungen

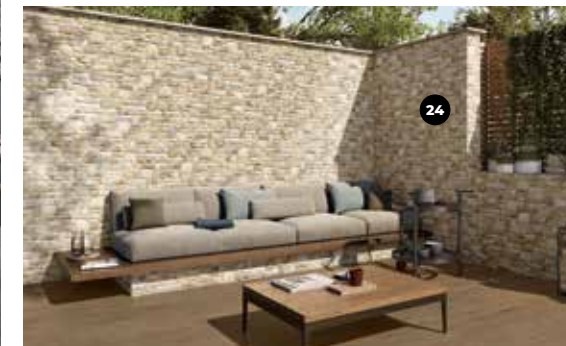

NOVITÀ - NEW - NOUVEAUTÉ - NEU

NovaBell OutWalk



L'eccezionale resistenza del 20mm diventa superlativa nella versione 30mm. I nuovi prodotti Outwalk30, grazie al peso superiore delle lastre ed allo spessore maggiorato a 30 mm, oltre ai metodi tradizionali di posa e destinazione d'uso del 20mm, permettono l'utilizzo a secco anche per uso carrabile leggero. Non è più perciò necessario l'incollaggio delle lastre.

Utilizzo / Intended use / Possibilités d'usage / Anwendungsbereiche



Giardini
Garden
Jardins
Gärten



Piscina
Pool
Piscines
Schwimmbad



Cortili
Courtyards
Cours
Höfe



Terrazze
Terraces
Terrasses
Terrassen



Aree Carrabili
Driveable areas
Rues carrossables
Befahrbare Bereiche



Aeroporti
Airports
Aéroports
Flughäfen



Stazioni ferroviarie
Train stations
Gares
Bahnhöfe



Piste ciclabili
Bicycle paths
Pistes cyclables
Fahrradwege



Marciaiedi / Camminamenti
Sidewalks / Walkways
Trottoirs / Chemins
Bürgersteige / Gehwege



Viali
Avenues
Boulevards
Alleen



La posa di Outwalk30 su una superficie di stabilizzato di sabbia o ghiaio spaccato compattati e preparati a dovere, deve prevedere sempre l'utilizzo di distanziatori in materiale plastico.

Installation of Outwalk30 on a surface of compacted and properly prepared stabilised sand or split gravel must always include the use of plastic clips.

Sur les surfaces en sable stabilisé ou en gravier stabilisé, compactées et préparées dans les règles de l'art, les produits Outwalk30 doivent toujours être posés avec des croisillons en plastique.

Bei der Verlegung von Outwalk30 auf einer mit Sand, Schotter oder Kies stabilisierten und nach Gebühr verdichteten und vorbereiteten Oberfläche sind stets entsprechende Abstandhalter-Verlegehilfen aus Kunststoff vorzusehen.



The exceptional strength of the 20 mm version is superlative in the 30 mm. The new Outwalk30 products, thanks to the higher weight of the slabs and the 30 mm extra thickness, in addition to traditional installation methods and use of the 20 mm, **allow dry use even for light drive-over areas**. It is therefore no longer necessary to glue the slabs together.

L'extraordinaire résistance du 20 mm devient superlative dans la version 30 mm. En raison du poids plus important des dalles et de leur grande épaisseur de 30 mm, les nouveaux produits Outwalk30 peuvent être posés non seulement de manière traditionnelle et pour les applications du 20 mm, **mais aussi à sec, y compris sur les surfaces exposées à la circulation peu fréquente de véhicules**. Les dalles ne doivent plus être collées.

Die außerordentliche Widerstandsfähigkeit der 20-mm-Ausführung wird von der 30-mm-Version noch bei weitem übertroffen. Dank des höheren Gewichts der Platten und der größeren Stärke von 30 mm können die neuen Produkte Outwalk30 nicht nur nach traditionellen Methoden verlegt und wie die 20-mm-Versionen eingesetzt, **sondern auch im Trockenverfahren verlegt werden, sodass ggf. auch leichte Fahrzeuge darüber fahren können**. Die Verlegung in Mörtel oder mit Kleber ist somit nicht zwingend erforderlich.

Colori disponibili / Colours available / Couleurs disponibles / Verfügbare Farben

PIETRA / STONE / PIERRE / STEIN										
THERMAE			ASPEN							
CAMEL	80x80x3	60x60x3	40x80x3	ROCK GREY	80x80x3	60x60x3	40x80x3			
	TRM 368R	TRM 360R	TRM 348R		APN 188R	APN 160R	APN 148R			
PIETRA / STONE / PIERRE / STEIN										
LOUNGE			NORGESTONE			CEMENTO / CONCRETE / BÉTON / BETON				
STEEL	80x80x3	60x60x3	40x80x3	DARK GREY	80x80x3	60x60x3	40x80x3	ANTRACITE	80x80x3	60x60x3
	LNG 288R	LNG 260R	LNG 248R		NST 288R	NST 260R	NST 248R		OP 288R	OP 260R



LOOK ETEROGENEI.

Legno, pietra, cemento: il gres porcellanato NovaBell evolve tecnologicamente per esprimere linguaggi estetici contemporanei. Le superfici per esterno OutWalk restituiscono spazi coinvolgenti e naturali.

A VARIETY OF LOOKS.

Wood, stone, concrete: NovaBell porcelain stoneware evolves its technologies to express contemporary aesthetic languages. OutWalk outdoor surfaces create enticing, natural spaces.

ALLURES HÉTÉROGÈNES.

Bois, pierre, béton : le grès cérame NovaBell passe par une évolution technologique pour exprimer les langages esthétiques d'aujourd'hui. Les surfaces pour extérieur OutWalk dessinent des cadres séduisants et naturels.

VIELFÄLTIGE LOOKS.

Holz, Stein, Beton: Feinsteinzeug von NovaBell steht für zeitgemäßes Design, das auf einer kontinuierlichen technologischen Weiterentwicklung basiert. Die Outdoor-Beläge OutWalk schaffen ansprechende und natürlich wirkende Flächen im Außenraum.

PRODUCT INSPIRATIONS



STONE

36_ LANDSTONE

38_ MAXIMA

40_ LOUNGE

42_ THERMAE

44_ ASPEN

46_ STONE BOX

PAVED

URBE

DOLOMIA

BLUE STONE

GIAYA MULTICOLOR

56_ NORGESTONE

58_ DAVOS

60_ ALLBLACK

62_ SOVEREIGN

64_ KINGSTONE

66_ IMPERIAL VENICE



WOOD

70_ NORDIC WOOD

72_ NORDIC WOON FLAMED

74_ ARTWOOD

76_ EICHE

78_ MY SPACE

80_ TIME DESIGN

82_ QUERCUS



METAL / CONCRETE

86_ FORGE

88_ OPEN

90_ OXY

92_ OVERLAND



RUSTIC

96_ LUMIÈRE

98_ MATERIA

STONE

53
COLORS

9
SIZES
RECTIFIED

2
THICKNESS

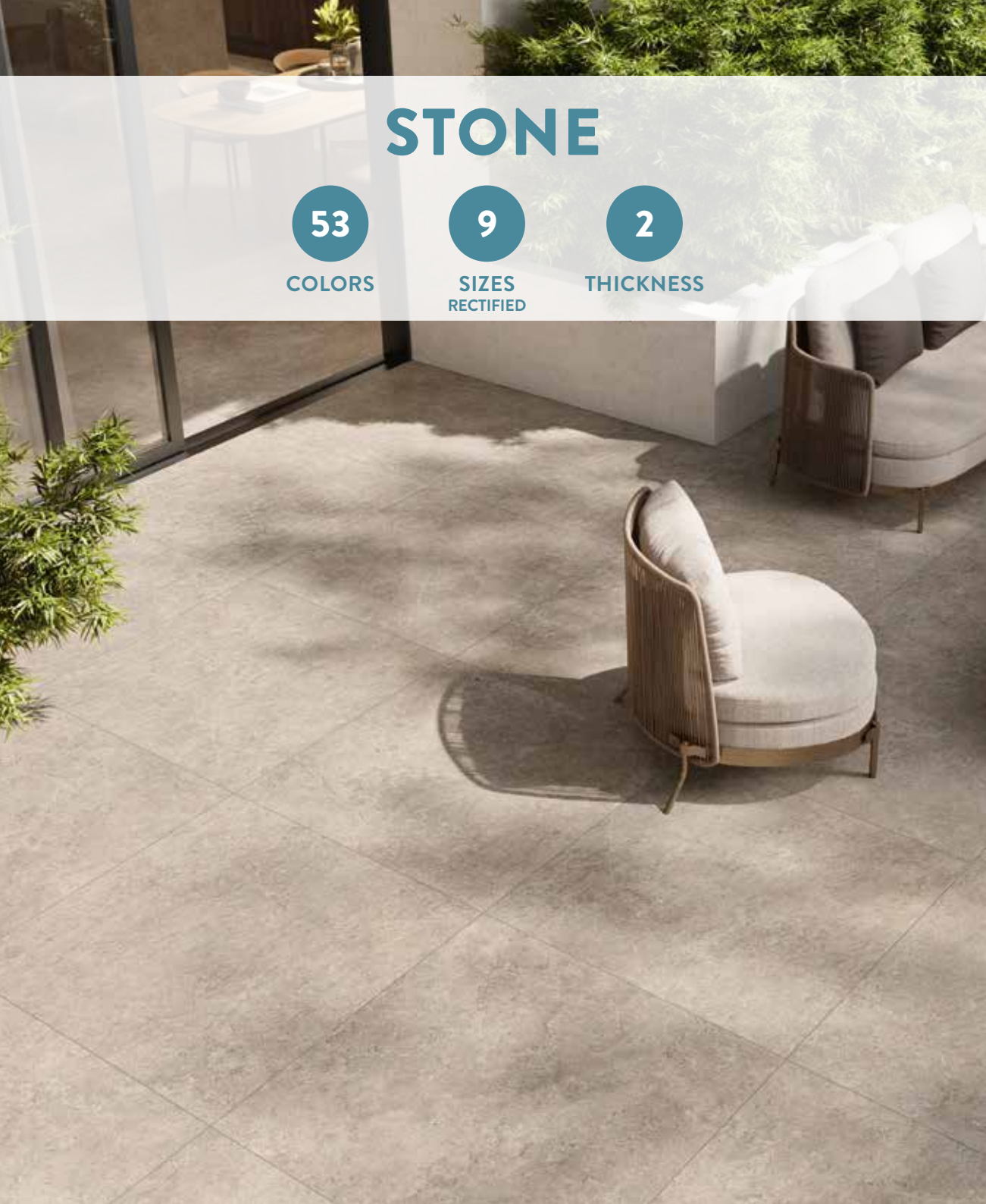

										36_ LANDSTONE
										<p>100x100 . 39^{3/4} / ex 39^{3/4} / f</p> <p>60x120 . 23^{3/4} / ex 47^{3/4} / f</p> <p>60x90 . 23^{3/4} / ex 35^{3/4} / f</p> <p>60x60 . 23^{3/4} / ex 23^{3/4} / f</p>
										40_ LOUNGE
										<p>100x100 . 39^{3/4} / ex 39^{3/4} / f</p> <p>80x80 . 31^{1/2} / ex 31^{1/2} / f</p> <p>60x120 . 23^{3/4} / ex 47^{3/4} / f</p> <p>60x90 . 23^{3/4} / ex 35^{3/4} / f</p> <p>60x60 . 23^{3/4} / ex 23^{3/4} / f</p> <p>MULTISIZE</p>
										42_ THERMAE
										<p>100x100 . 39^{3/4} / ex 39^{3/4} / f</p> <p>60x120 . 23^{3/4} / ex 47^{3/4} / f</p> <p>60x90 . 23^{3/4} / ex 35^{3/4} / f</p> <p>MULTISIZE</p> <p>60x60 . 23^{3/4} / ex 23^{3/4} / f</p>
										44_ ASPEN
										<p>100x100 . 39^{3/4} / ex 39^{3/4} / f</p> <p>60x180 . 23^{3/4} / ex 70^{3/4} / f</p> <p>60x120 . 23^{3/4} / ex 47^{3/4} / f</p> <p>60x90 . 23^{3/4} / ex 35^{3/4} / f</p> <p>MULTISIZE</p> <p>60x60 . 23^{3/4} / ex 23^{3/4} / f</p>
										58_ DAVOS
										<p>60x120 . 23^{3/4} / ex 47^{3/4} / f</p> <p>60x90 . 23^{3/4} / ex 35^{3/4} / f</p> <p>60x60 . 23^{3/4} / ex 23^{3/4} / f</p>
										46_ STONE BOX
										<p>60x120 . 23^{3/4} / ex 47^{3/4} / f</p> <p>60x90 . 23^{3/4} / ex 35^{3/4} / f</p> <p>60x60 . 23^{3/4} / ex 23^{3/4} / f</p> <p>30x60 . 11^{3/4} / ex 23^{3/4} / f</p> <p>MULTISIZE</p>
										56_ NORGESTONE
										<p>60x180 . 23^{3/4} / ex 70^{3/4} / f</p> <p>60x120 . 23^{3/4} / ex 47^{3/4} / f</p> <p>60x90 . 23^{3/4} / ex 35^{3/4} / f</p> <p>MULTISIZE</p> <p>60x60 . 23^{3/4} / ex 23^{3/4} / f</p>
										60_ ALLBLACK
										<p>60x90 . 23^{3/4} / ex 35^{3/4} / f</p> <p>MULTISIZE</p> <p>60x60 . 23^{3/4} / ex 23^{3/4} / f</p>
										64_ KINGSTONE
										<p>80x80 . 31^{1/2} / ex 31^{1/2} / f</p>
										38_ MAXIMA
										<p>60x120 . 23^{3/4} / ex 47^{3/4} / f</p>

80x80 . 31^{1/2} / ex 31^{1/2} / f
40x80 . 15^{3/4} / ex 31^{1/2} / f
60x60 . 23^{3/4} / ex 23^{3/4} / f

30 MM

COLLECTION
STONECREEK
80

Sand Moon	Oxide	Snow	Rock Grey	Basalt

80x80 . 31^{1/2} / ex 31^{1/2} / f
40x80 . 15^{3/4} / ex 31^{1/2} / f
60x60 . 23^{3/4} / ex 23^{3/4} / f

30 MM

COLLECTION
STONECREEK
50

Taupe	Ivory	Light Grey	Dark Grey	Slate

60x60 . 23^{3/4} / ex 23^{3/4} / f

20 MM

COLLECTION
STONECREEK
40

Beige	Antracite

COLLECTION
STONECREEK
70

Beige	Bianco	Grigio	Antracite

Sale e pepe	Grigio	Nero

62_ SOVEREIGN
60x90 . 23^{3/4} / ex 35^{3/4} / f
MULTISIZE
60x60 . 23^{3/4} / ex 23^{3/4} / f

66_ IMPERIAL
VENICE
60x60 . 23^{3/4} / ex 23^{3/4} / f

Royal Beige	Platinum	Silver	Black

Sand	Grigio	Dark Brown

LANDSTONE

100x100 39¹¹/₁₆x39¹¹/₁₆ - 60x120 23¹¹/₁₆x47¹¹/₁₆ - 60x90 23¹¹/₁₆x35¹¹/₁₆ - 60x60 23¹¹/₁₆x23¹¹/₁₆



RAW WHITE



STONE

RAW WHITE

60x120 / 60x90

CLAY

100x100 / 60x120 / 60x90 / 60x60

TAUPE

100x100 / 60x120 / 60x90 / 60x60

EARTH

60x120 / 60x90

GRAVEL

100x100 / 60x120 / 60x90 / 60x60

CARBON

100x100 / 60x120 / 60x60

20 MM 9 MM

	20 MM				9 MM							
	100x100 39 ¹¹ / ₁₆ x39 ¹¹ / ₁₆	60x120 23 ¹¹ / ₁₆ x47 ¹¹ / ₁₆	60x90 23 ¹¹ / ₁₆ x35 ¹¹ / ₁₆	60x60 23 ¹¹ / ₁₆ x23 ¹¹ / ₁₆	100x100 39 ¹¹ / ₁₆ x39 ¹¹ / ₁₆	60x120 23 ¹¹ / ₁₆ x47 ¹¹ / ₁₆	60x90 23 ¹¹ / ₁₆ x35 ¹¹ / ₁₆	60x60 23 ¹¹ / ₁₆ x23 ¹¹ / ₁₆	30x60 11 ¹¹ / ₁₆ x23 ¹¹ / ₁₆	100x100 AS 39 ¹¹ / ₁₆ x39 ¹¹ / ₁₆	30x60 AS 11 ¹¹ / ₁₆ x23 ¹¹ / ₁₆	
COLOR	01 1135	01 1125	01 1120	02 1110	02 1090	02 1075	02 1070	03 1065	07 1035	02 1090	07 1040	
Raw White	-	LST 89RT	LST 869R	-	LST 108R	LST 82RT	-	LST 80RT	LST 86RT	-	-	
Clay	LST 124R	LST 49RT	LST 469R	LST 460R	LST 104R	LST 42RT	LST 41RT	LST 40RT	LST 46RT	LST 104AS	LST 46AS	
Taupe	LST 125R	LST 59RT	LST 569R	LST 560R	LST 105R	LST 52RT	LST 51RT	LST 50RT	LST 56RT	LST 105AS	LST 56AS	
Earth	-	LST 69RT	LST 669R	LST 660R	LST 106R	LST 62RT	LST 61RT	LST 60RT	LST 66RT	-	-	
Gravel	LST 121R	LST 19RT	LST 169R	LST 160R	LST 101R	LST 12RT	LST 11RT	LST 10RT	LST 16RT	LST 101AS	LST 16AS	
Carbon	LST 122R	LST 29RT	LST 269R	LST 260R	LST 102R	LST 22RT	-	LST 20RT	LST 26RT	-	-	

MAXIMA

60x120 23^{5/8}x47^{1/4}



GRIGIO 60x120



STONE



SAND

60x120



GRIGIO

60x120



DARK BROWN

60x120

20 MM 9 MM

60x120 23 ^{5/8} x47 ^{1/4}	60x120 23 ^{5/8} x47 ^{1/4}	20x120 7 ^{7/8} x47 ^{1/4}	60x60 23 ^{5/8} x23 ^{5/8}	30x60 11 ^{13/16} x23 ^{5/8}
COLOR 01 1125	02 1075	04 1090	03 1065	07 1040

Sand	MXM 462R	MXM 42RT	MXM 41RT	MXM 40RT	MXM 46RT
Grigio	MXM 162R	MXM 12RT	MXM 11RT	MXM 10RT	MXM 16RT
Dark Brown	MXM 262R	MXM 22RT	MXM 21RT	MXM 20RT	MXM 26RT

i PEZZI SPECIALI
SPECIAL COORDINATED PIECES / PIÈCES SPÉCIALES COORDONNÉES / ZUSAMMENSTELLBARE FORMTEILE INFO PAG. 102

LOUNGE

100x100 39¹¹/₁₆ x 39¹¹/₁₆ - 80x80 31¹¹/₁₆ x 31¹¹/₁₆ - 60x120 23¹¹/₁₆ x 47¹¹/₁₆ - 60x90 23¹¹/₁₆ x 35¹¹/₁₆ - 60x60 23¹¹/₁₆ x 23¹¹/₁₆ - Multisize



STEEL 60x120



STONE



STEEL

100x100 / 80x80 / 60x120 / 60x90 / 60x60 / MULTISIZE



3cm

80x80 / 40x80 / 60x60



SHADOW

100x100 / 80x80 / 60x120 / 60x90 / 60x60 / MULTISIZE



PEARL

100x100 / 80x80 / 60x120 / 60x90 / 60x60 / MULTISIZE



EARTH

80x80 / 60x120 / 60x90 / 60x60 / MULTISIZE

	20 MM						30 MM			9 MM				
	100x100	80x80	60x120	60x90	60x60	Multisize	80x80	40x80	60x60	100x100	80x80	60x120	60x60	30x60
COLOR	01 1135	01 1135	01 1125	01 1120	02 1110	top 1130	01 1150	02 1135	02 1130	02 1090	02 1080	02 1075	03 1065	07 1035
Steel	LNG 122R	LNG 27RT	LNG 262R	LNG 269R	LNG 120R	LNG M233	LNG 288R	LNG 248R	LNG 260R	LNG 102R	LNG 28RT	LNG 22RT	LNG 20RT	LNG 26RT
Shadow	LNG 129R	LNG 97RT	LNG 962R	LNG 969R	LNG 190R	LNG M933	-	-	-	LNG 109R	LNG 98RT	LNG 92RT	LNG 90RT	LNG 96RT
Pearl	LNG 121R	LNG 17RT	LNG 162R	LNG 169R	LNG 110R	LNG M133	-	-	-	LNG 101R	LNG 18RT	LNG 12RT	LNG 10RT	LNG 16RT
Earth	-	LNG 67RT	LNG 662R	LNG 669R	LNG 160R	LNG M633	-	-	-	LNG 106R	LNG 68RT	LNG 62RT	LNG 60RT	LNG 66RT

PEZZI SPECIALI
SPECIAL COORDINATED PIECES / PIÈCES SPÉCIALES COORDONNÉES / ZUSAMMENSTELLBARE FORMTEILE INFO PAG. 102



THERMAE

100x100 39⁷/₈x39⁷/₈ - 60x120 23⁷/₈x47¹/₄ - 60x90 23⁵/₈x35⁷/₁₆ - MULTISIZE

STONECREEK 90 60x60



CARAMEL 60x90



STONE



CARAMEL

100x100 / 60x120 / 60x90 / MULTISIZE / 60x60 STONECREEK 90



3cm

80x80 / 40x80 / 60x60



HONEY

100x100 / 60x120 / 60x90 / MULTISIZE / 60x60 STONECREEK 90



STORM

100x100 / 60x120 / 60x90 / MULTISIZE / 60x60 STONECREEK 90

20 MM

30 MM

9 MM

	20 MM				30 MM			9 MM								
	100x100 39 ⁷ / ₈ x39 ⁷ / ₈	60x120 23 ⁷ / ₈ x47 ¹ / ₄	60x90 23 ⁵ / ₈ x35 ⁷ / ₁₆	Multisize kcp	60x60 23 ⁷ / ₈ x23 ⁷ / ₈	80x80 39 ⁷ / ₈ x39 ⁷ / ₈	40x80 15 ¹ / ₄ x39 ⁷ / ₈	60x60 39 ⁷ / ₈ x39 ⁷ / ₈	100x100 39 ⁷ / ₈ x39 ⁷ / ₈	60x120 23 ⁷ / ₈ x47 ¹ / ₄	60x90 23 ⁵ / ₈ x35 ⁷ / ₁₆	60x60 23 ⁵ / ₈ x23 ⁵ / ₈	30x60 11 ¹³ / ₁₆ x23 ⁵ / ₈	10x30 3 ¹ / ₈ x11 ¹³ / ₁₆	60x90 AS 23 ⁵ / ₈ x35 ⁷ / ₁₆	
COLOR	01 1140	01 1130	01 1125	kcp 1135	02 1110	01 1150	02 1135	02 1130	02 1100	02 1085	02 1080	03 1065	07 1035	28 1075	02 1085	
Honey	TRM 124R	TRM 462R	TRM 469R	TRM M433	Y90460	-	-	-	TRM 104R	TRM 42RT	TMR 49RT	TMR 40RT	TRM 46RT	TRM 41RT	TMR 49AS	
Caramel	TRM 123R	TRM 362R	TRM 369R	TRM M333	Y90360	TRM 388R	TRM 348R	TRM 360R	TRM 103R	TRM 32RT	TMR 39RT	TMR 30RT	TRM 36RT	TRM 31RT	TMR 39AS	
Storm	TRM 122R	TRM 262R	TRM 269R	TRM M233	Y90260	-	-	-	TRM 102R	TRM 22RT	TMR 29RT	TMR 20RT	TRM 26RT	TRM 21RT	TMR 29AS	

PEZZI SPECIALI / SPECIAL COORDINATED PIECES / PIÈCES SPÉCIALES COORDONNÉES / ZUSAMMENSTELLBARE FORMTEILE INFO PAG. 102

ASPEN

100x100 39^{15/16}x39^{15/16} - 60x180 23^{15/16}x70^{7/16} - 60x120 23^{15/16}x47^{1/4} - 60x90 23^{15/16}x35^{17/16} - MULTISIZE

STONECREEK ⁸⁰ 60x60



SNOW MULTISIZE



STONE



ROCK GREY

100x100 / 60x180 / 60x120 / 60x90 / MULTISIZE / 60x60 STONECREEK ⁸⁰



3cm

80x80 / 40x80 / 60x60



BASALT

100x100 / 60x180 / 60x120 / 60x90 / MULTISIZE / 60x60 STONECREEK ⁸⁰



SNOW

60x180 / 60x90 / MULTISIZE



OXIDE

100x100 / 60x180 / 60x120 / 60x90 / MULTISIZE / 60x60 STONECREEK ⁸⁰



SAND MOON

100x100 / 60x120 / 60x60 STONECREEK ⁸⁰

20 MM

30 MM

9 MM

COLOR	20 MM					30 MM			9 MM						
	100x100 39 ^{15/16} x39 ^{15/16}	60x180 23 ^{15/16} x70 ^{7/16}	60x120 23 ^{15/16} x47 ^{1/4}	60x90 23 ^{15/16} x35 ^{17/16}	Multisize Top 1130	STONECREEK ⁸⁰ 60x60 23 ^{15/16} x23 ^{15/16}	80x80 39 ^{15/16} x39 ^{15/16}	40x80 15 ^{15/16} x39 ^{15/16}	60x60 39 ^{15/16} x39 ^{15/16}	100x100 39 ^{15/16} x39 ^{15/16}	60x120 23 ^{15/16} x47 ^{1/4}	60x60 23 ^{15/16} x23 ^{15/16}	30x60 11 ^{15/16} x23 ^{15/16}	60x60 AS 23 ^{15/16} x35 ^{17/16}	30x60 AS 11 ^{15/16} x23 ^{15/16}
Rock Grey	01 1135	01 1130	01 1125	01 1120	Top 1130	Y80160	01 1150	02 1135	02 1130	02 1090	02 1075	03 1065	07 1035	03 1070	07 1040
Basalt	APN 121R	APN 118R	APN 19RT	APN 169R	APN M133	Y80260	-	-	-	APN 101R	APN 12RT	APN 10RT	APN 16RT	APN 17AS	APN 14AS
Snow	-	APN 818R	-	APN 869R	APN M833	-	-	-	-	APN 102R	APN 22RT	APN 20RT	APN 26RT	APN 27AS	APN 24AS
Oxide	APN 127R	APN 718R	APN 79RT	APN 769R	APN M733	Y80760	-	-	-	APN 108R	APN 82RT	APN 80RT	APN 86RT	-	-
Sand Moon	APN 124R	-	APN 49RT	-	-	Y80460	-	-	-	APN 107R	APN 72RT	APN 70RT	APN 76RT	-	-

PEZZI SPECIALI / SPECIAL COORDINATED PIECES / PIÈCES SPÉCIALES COORDONNÉES / ZUSAMMENSTELLBARE FORMTEILE INFO PAG. 102

STONE BOX - PAVED

60x120 23⁷/₈x47¹/₄ - 60x90 23⁵/₈x35⁷/₁₆ - 60x60 23⁵/₈x23⁵/₈ - MULTISIZE



BROWN 60x120



STONE



BROWN

60x120 / 60x90 / 60x60 / Multisize



GREY

60x120 / 60x90 / 60x60 / Multisize



BASALT

60x120 / 60x90 / 60x60 / Multisize

20
MM

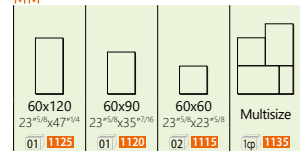

COLOR	60x120 23 ⁷ / ₈ x47 ¹ / ₄ 01 1125	60x90 23 ⁵ / ₈ x35 ⁷ / ₁₆ 01 1120	60x60 23 ⁵ / ₈ x23 ⁵ / ₈ 02 1115	Multisize 1p 1135
Brown	SBA 662R	SBA 669R	SBA 660R	SBA M633
Grey	SBA 162R	SBA 169R	SBA 160R	SBA M133
Basalt	SBA 262R	SBA 269R	SBA 260R	SBA M233

STONE BOX - URBE

60x120 23⁵/₈x47¹/₄ - 60x90 23⁵/₈x35⁷/₁₆ - 60x60 23⁵/₈x23⁵/₈ - MULTISIZE



STONE



CREAM

60x120



WHITE GREY

60x120



SILVER

60x120

20 MM

9 MM

	20 MM				9 MM				
	60x120 23 ⁵ / ₈ x47 ¹ / ₄	60x90 23 ⁵ / ₈ x35 ⁷ / ₁₆	60x60 23 ⁵ / ₈ x23 ⁵ / ₈	Multisize	60x120 23 ⁵ / ₈ x47 ¹ / ₄	60x60 23 ⁵ / ₈ x23 ⁵ / ₈	30x60 11 ¹ / ₂ x23 ⁵ / ₈	10x60 3 ¹ / ₂ x23 ⁵ / ₈	10x30 3 ¹ / ₂ x11 ¹ / ₂
COLOR	01 1125	01 1120	02 1115	tp 1135	02 1085	03 1065	07 1035	12 1095	28 1075
Cream	SBU 462R	SBU 469R	SBU 460R	SBU M433	SBU 42RT	SBU 40RT	SBU 46RT	SBU 47RT	SBU 41RT
White Grey	SBU 862R	SBU 869R	SBU 860R	SBU M833	SBU 82RT	SBU 80RT	SBU 86RT	SBU 87RT	SBU 81RT
Silver	SBU 162R	SBU 169R	SBU 160R	SBU M133	SBU 12RT	SBU 10RT	SBU 16RT	SBU 17RT	SBU 11RT

PEZZI SPECIALI
SPECIAL COORDINATED PIECES / PIÈCES SPÉCIALES COORDONNÉES / ZUSAMMENSTELLBARE FORMTEILE INFO PAG. 102

STONE BOX - DOLOMIA

60x120 23^{5/8}x47^{1/4} - 60x60 23^{5/8}x23^{5/8}



STONE



DOLOMIA GOLD

60x120 / 60x60



DOLOMIA GREY

60x120 / 60x60

20
MM

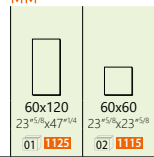

COLOR	01	02
Dolomia Gold	SBD 462R	SBD 460R
Dolomia Grey	SBD 162R	SBD 160R

PEZZI SPECIALI
SPECIAL COORDINATED PIECES / PIÈCES SPÉCIALES COORDONNÉES / ZUSAMMENSTELLBARE FORMTEILE INFO PAG. 102

STONE BOX - BLUE STONE

60x90 23^{75/8}x35^{77/16} - 60x60 23^{75/8}x23^{75/8} - MULTISIZE

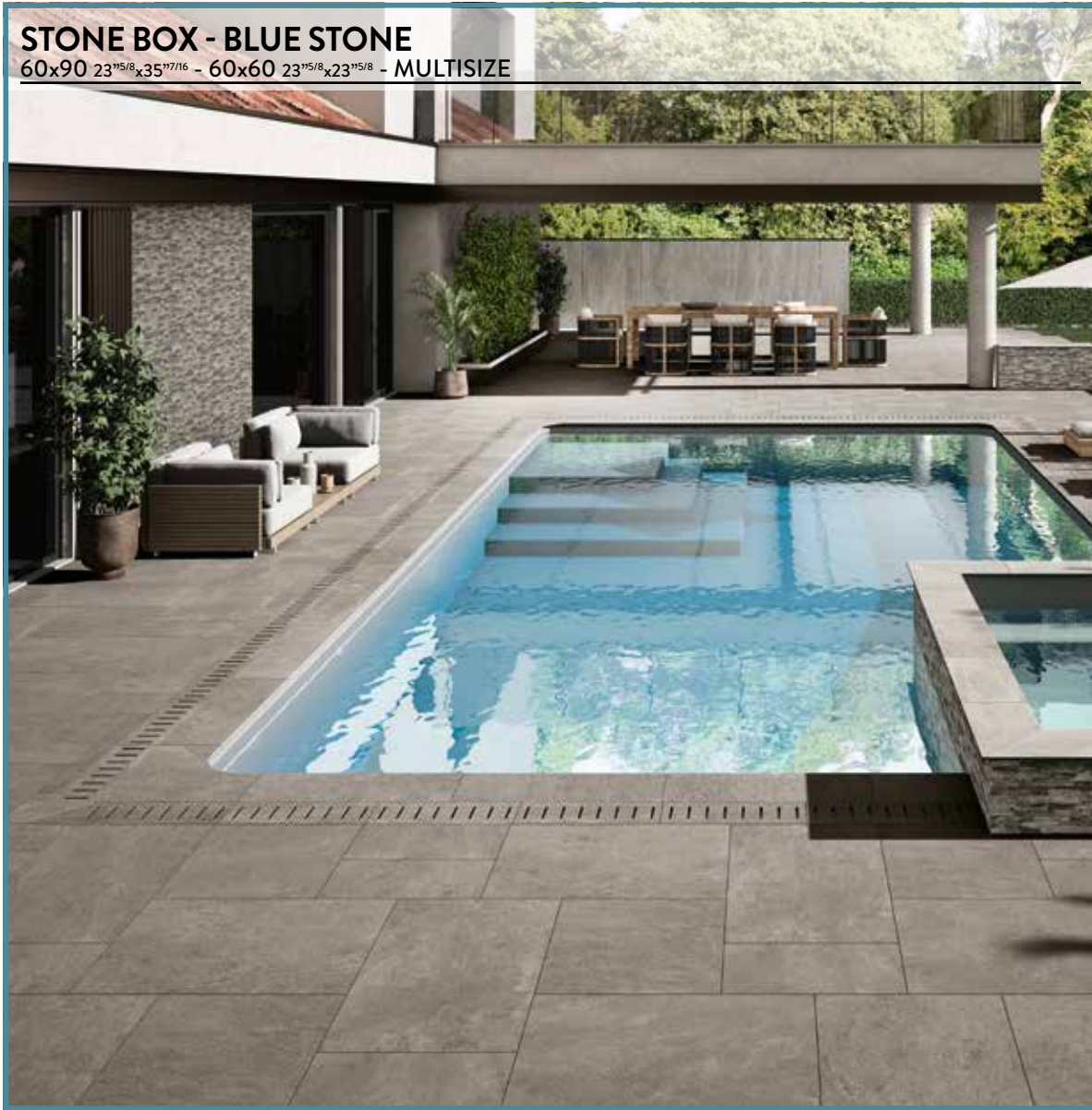

STONE

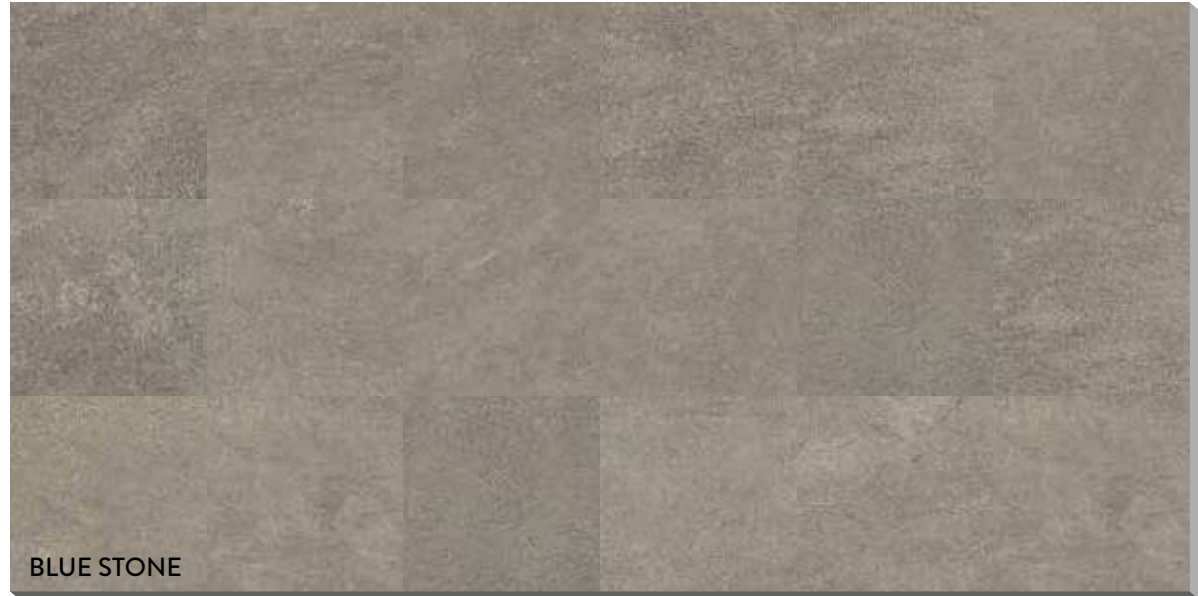

BLUE STONE

60x90 / 60x60 / MULTISIZE



20 MM

60x90	60x60	Multisize
23 ^{75/8} x35 ^{77/16}	23 ^{75/8} x23 ^{75/8}	
01 1120	02 1115	1cp 1130

COLOR

Blue Stone	SBP 169R	SBP 160R	SBP M133
------------	----------	----------	----------

i PEZZI SPECIALI / SPECIAL COORDINATED PIECES / PIÈCES SPÉCIALES COORDONNÉES / ZUSAMMENSTELLBARE FORMTEILE INFO PAG. 102

STONE BOX - GIAVA MULTICOLOR

60x60 23⁷⁵/₈x23⁷⁵/₈ - 30x60 11¹³/₁₆x23⁷⁵/₈



STONE



GIAVA MULTICOLOR

60x60 / 30x60



	20 MM	9 MM
	60x60 23 ⁷⁵ / ₈ x23 ⁷⁵ / ₈	30x60 11 ¹³ / ₁₆ x23 ⁷⁵ / ₈
COLOR	02 1115	03 1115
	SBG 160R	SBG 163R
		07 1000
		SBG 11AS

PEZZI SPECIALI
SPECIAL COORDINATED PIECES / PIÈCES SPÉCIALES COORDONNÉES / ZUSAMMENSTELLBARE FORMTEILE INFO PAG. 102

NORGESTONE

60x180 23⁷/₈x70¹/₄ - 60x120 23⁷/₈x47¹/₄ - 60x90 23⁷/₈x35⁷/₁₆ - MULTISIZE

STONECREEK 50 60x60



LIGHT GREY 60x120



STONE



DARK GREY

60x180 / 60x120 / 60x90 / MULTISIZE / 60x60 STONECREEK 50

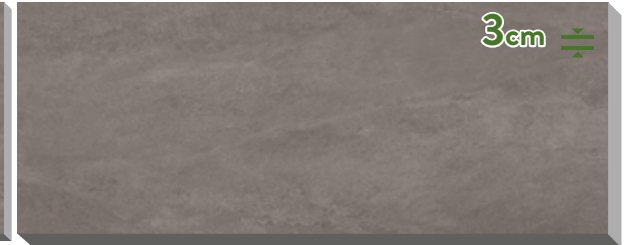

LIGHT GREY

60x180 / 60x120 / 60x90 / MULTISIZE / 60x60 STONECREEK 50



SLATE

60x120 / 60x60 STONECREEK 50



IVORY

60x90 / MULTISIZE



TAUPE

60x120 / 60x60 STONECREEK 50

20 MM

30 MM

9 MM

COLOR	20 MM				30 MM			9 MM					
	60x180 23 ⁷ / ₈ x70 ¹ / ₄ 01 1130	60x120 23 ⁷ / ₈ x47 ¹ / ₄ 01 1125	60x90 23 ⁷ / ₈ x35 ⁷ / ₁₆ 01 1120	Multisize top 1130	60x60 23 ⁷ / ₈ x23 ⁷ / ₈ 02 1110	80x80 39 ¹ / ₈ x39 ¹ / ₈ 01 1150	40x80 15 ¹ / ₈ x39 ¹ / ₈ 02 1135	60x60 39 ¹ / ₈ x39 ¹ / ₈ 02 1130	60x120 23 ⁷ / ₈ x47 ¹ / ₄ 02 1075	30x120 11 ¹ / ₈ x47 ¹ / ₄ 03 1080	80x80 31 ¹ / ₈ x31 ¹ / ₈ 02 1075	60x60 23 ⁷ / ₈ x23 ⁷ / ₈ 03 1065	30x60 11 ¹ / ₈ x23 ⁷ / ₈ 07 1035
Dark Grey	NST 218R	NST 29RT	NST 269R	NST M233	Y50260	NST 288R	NST 248R	NST 260R	NST 22RT	NST 23RT	NST 28RT	NST 20RT	NST 26RT
Light Grey	NST 118R	NST 19RT	NST 169R	NST M133	Y50160	-	-	-	NST 12RT	NST 13RT	NST 18RT	NST 10RT	NST 16RT
Slate	-	NST 99RT	-	-	Y50960	-	-	-	NST 92RT	NST 93RT	-	NST 90RT	NST 96RT
Ivory	-	-	NST 869R	NST M833	-	-	-	-	NST 82RT	NST 83RT	-	NST 80RT	NST 86RT
Taupe	-	NST 49RT	-	-	Y50460	-	-	-	NST 42RT	NST 43RT	NST 48RT	NST 40RT	NST 46RT

PEZZI SPECIALI / SPECIAL COORDINATED PIECES / PIÈCES SPÉCIALES COORDONNÉES / ZUSAMMENSTELLBARE FORMTEILE INFO PAG. 102

DAVOS

60x120 23^{5/8}x47^{1/4} - 60x90 23^{5/8}x35^{7/16} - 60x60 23^{5/8}x23^{5/8}



ANTRACITE 60x120



STONE



BEIGE

60x90 / 60x60



ALPI GREY

60x90 / 60x60



GRIGIO

60x120 / 60x90 / 60x60



ANTRACITE

60x120 / 60x90 / 60x60

20
MM

9
MM

	20 MM			9 MM		
	60x120 23 ^{5/8} x47 ^{1/4}	60x90 23 ^{5/8} x35 ^{7/16}	60x60 23 ^{5/8} x23 ^{5/8}	60x120 23 ^{5/8} x47 ^{1/4}	60x90 23 ^{5/8} x35 ^{7/16}	30x60 11 ^{13/16} x23 ^{5/8}
COLOR	01 1125	01 1120	02 1115	02 1085	02 1080	07 1055
Beige	-	DVS 469R	DVS 460R	-	DVS 49RT	DVS 46RT
Alpi Grey	-	DVS 769R	DVS 760R	-	DVS 79RT	DVS 76RT
Grigio	DVS 162R	DVS 169R	DVS 160R	DVS 12RT	DVS 19RT	DVS 16RT
Antracite	DVS 262R	DVS 269R	DVS 260R	DVS 22RT	DVS 29RT	DVS 26RT

i PEZZI SPECIALI
SPECIAL COORDINATED PIECES / PIÈCES SPÉCIALES COORDONNÉES / ZUSAMMENSTELLBARE FORMTEILE INFO PAG. 102

ALLBLACK

60x90 23⁷/₁₆x35⁷/₁₆ - MULTISIZE

STONECREEK ⁷⁰ 60x60



GRIGIO 60x90



STONE



BEIGE

60x90 / MULTISIZE / 60x60 STONECREEK ⁷⁰



BIANCO

60x90 / MULTISIZE / 60x60 STONECREEK ⁷⁰



GRIGIO

60x90 / MULTISIZE / 60x60 STONECREEK ⁷⁰



ANTRACITE

60x90 / MULTISIZE / 60x60 STONECREEK ⁷⁰

20 MM 9 MM

COLOR	20 MM		9 MM				
	60x90 23 ⁷ / ₁₆ x35 ⁷ / ₁₆	Multisize 1130	60x60 23 ⁷ / ₁₆ x23 ⁷ / ₁₆	60x120 23 ⁷ / ₁₆ x47 ⁷ / ₁₆	60x90 23 ⁷ / ₁₆ x35 ⁷ / ₁₆	60x60 23 ⁷ / ₁₆ x23 ⁷ / ₁₆	30x60 11 ³ / ₁₆ x23 ⁷ / ₁₆
Beige	01 1120	1130	02 1110	02 1025	02 1070	03 1035	07 1035
Bianco	ALK 469R	ALK M433	Y70460	ALK 42RT	ALK 49RT	ALK 40RT	ALK 46RT
Grigio	ALK 869R	ALK M833	Y70860	ALK 82RT	ALK 89RT	ALK 80RT	ALK 86RT
Antracite	ALK 169R	ALK M133	Y70160	ALK 12RT	ALK 19RT	ALK 10RT	ALK 16RT
	ALK 269R	ALK M233	Y70260	ALK 22RT	ALK 29RT	ALK 20RT	ALK 26RT

i PEZZI SPECIALI / SPECIAL COORDINATED PIECES / PIÈCES SPÉCIALES COORDONNÉES / ZUSAMMENSTELLBARE FORMTEILE INFO PAG. 102

SOVEREIGN
60x90 23⁷⁵/₁₆x35⁷⁷/₁₆ - MULTISIZE

STONECREEK **40** 60x60



ANTRACITE MULTISIZE



STONE



BEIGE

60x90 / MULTISIZE / 60x60 STONECREEK **40**



ANTRACITE

60x90 / MULTISIZE / 60x60 STONECREEK **40**

20 MM		9 MM	
60x90 23 ⁷⁵ / ₁₆ x35 ⁷⁷ / ₁₆	Multisize	60x60 23 ⁷⁵ / ₁₆ x23 ⁷⁵ / ₁₆	60x120 23 ⁷⁵ / ₁₆ x47 ¹⁴ / ₁₆
01 1120	1tp 1130	02 1110	02 1075
Beige	SVN 469R SVN M433	Y40460 *	SVN 42RT SVN 40RT
Antracite	SVN 269R SVN M233	Y40960 *	SVN 20RT SVN 26RT
Grigio Chiaro	-	Y40160	SVN 12RT SVN 10RT
			SVN 16RT SVN 18RT
			SVN 28RT SVN 24RT
			SVN 48RT SVN 44RT
			SVN 44RT

i PEZZI SPECIALI
SPECIAL COORDINATED PIECES / PIÈCES SPÉCIALES COORDONNÉES / ZUSAMMENSTELLBARE FORMTEILE INFO PAG. 102



KINGSTONE

80x80 31¹¹/₂x31¹¹/₂



SILVER 80x80



STONE



ROYALE BEIGE

80x80



PLATINUM

80x80



SILVER

80x80



BLACK

80x80

20
MM



80x80

31¹¹/₂x31¹¹/₂

01 115

COLOR

Royale Beige	KST 47RT
Platinum	KST 17RT
Silver	KST 27RT
Black	KST 97RT

i PEZZI SPECIALI
SPECIAL COORDINATED PIECES / PIÈCES SPÉCIALES COORDONNÉES / ZUSAMMENSTELLBARE FORMTEILE INFO PAG. 102

IMPERIAL VENICE

60x60 23¹⁵/₈x23¹⁵/₈



SALE e PEPE 60x60



STONE

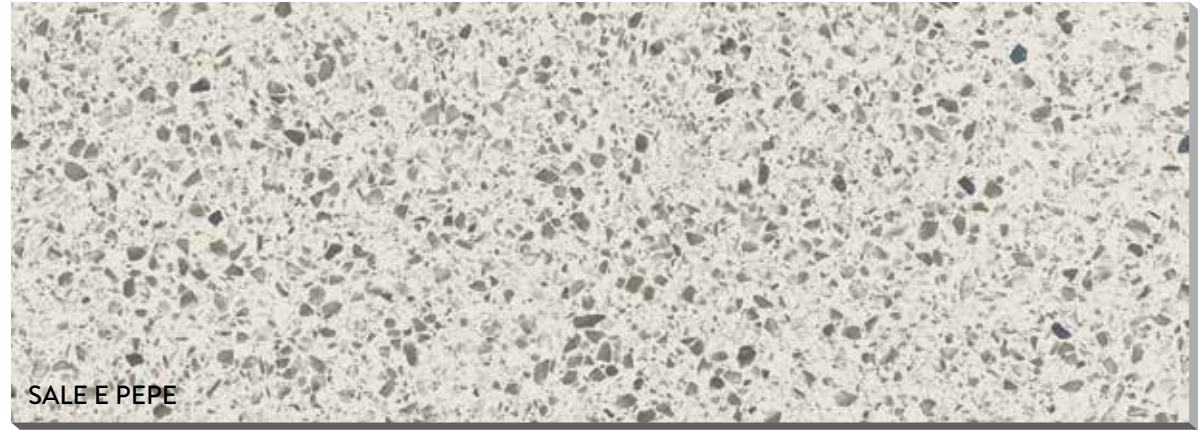

60x60

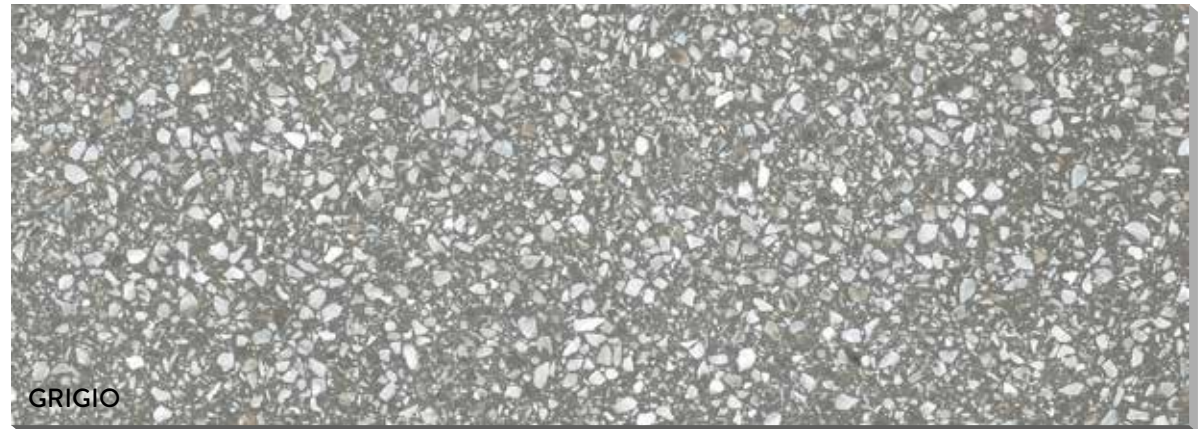

60x60



60x60

20 MM 9 MM

	60x60 23 ¹⁵ / ₈ x23 ¹⁵ / ₈	60x120 23 ¹⁵ / ₈ x47 ¹ / ₄	60x60 23 ¹⁵ / ₈ x23 ¹⁵ / ₈	30x60 11 ¹⁵ / ₈ x23 ¹⁵ / ₈
COLOR	02 1110	02 1085	03 1070	06 1060
Sale e Pepe	IMV 27RT	IMV 22RT	IMV 20RT	IMV 26RT
Grigio	IMV 17RT	IMV 12RT	IMV 10RT	IMV 16RT
Nero	IMV 97RT	IMV 92RT	IMV 90RT	IMV 96RT

i PEZZI SPECIALI
SPECIAL COORDINATED PIECES / PIÈCES SPÉCIALES COORDONNÉES / ZUSAMMENSTELLBARE FORMTEILE INFO PAG. 102

WOOD

23

COLORS

6

SIZES
RECTIFIED

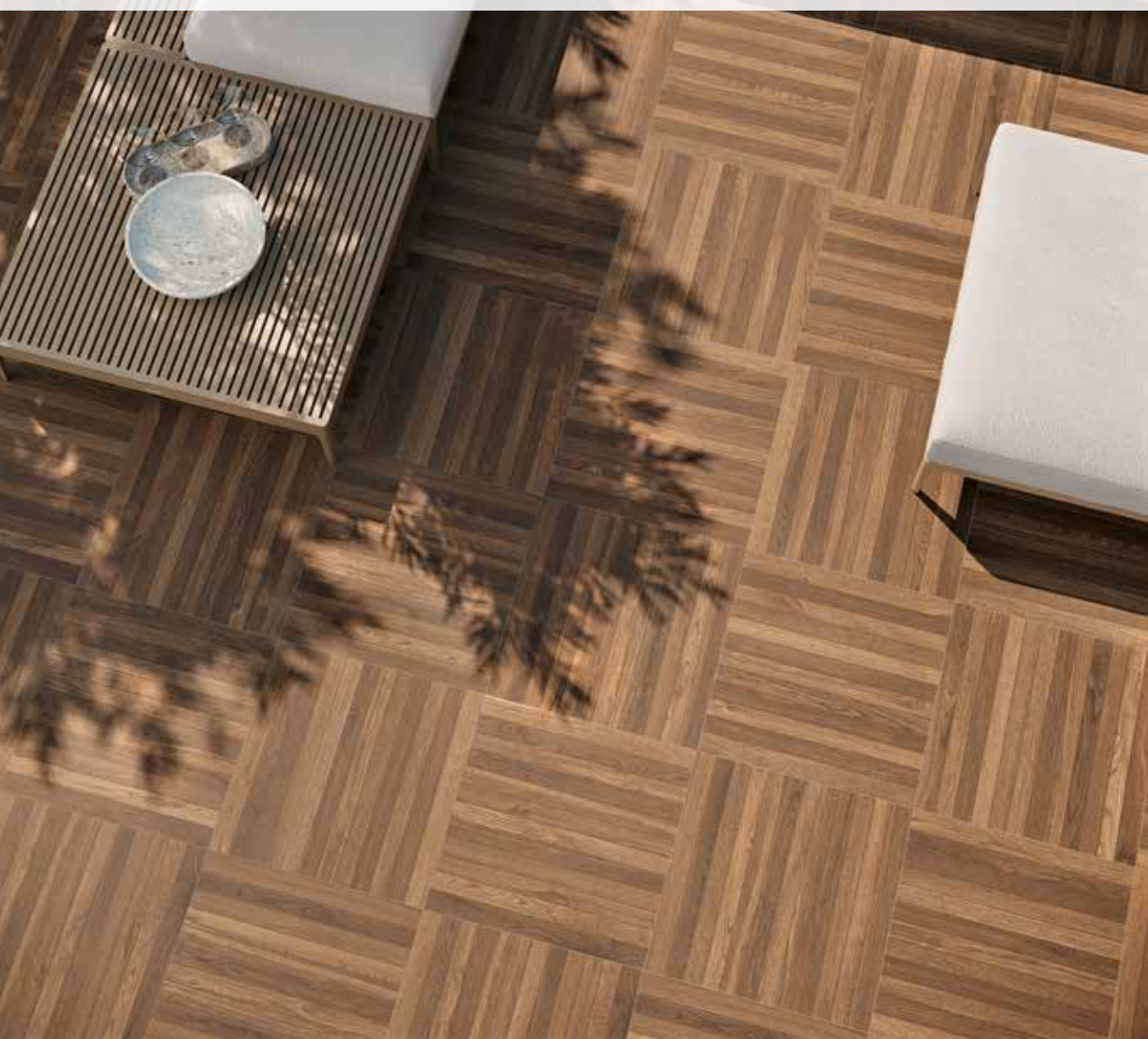

Blonde

Walnut

Pepper

70_ NORDIC WOOD

30x180 . 11³/₈ x 70³/₈
30x120 . 11³/₈ x 47³/₈
60x120 . 23³/₈ x 47³/₈
60x60 . 23³/₈ x 23³/₈



Blonde Bacchette

Walnut Bacchette

Pepper Bacchette



Blonde Flamed

Walnut Flamed

Pepper Flamed

72_ NORDIC WOOD FLAMED

30x120 . 11³/₈ x 47³/₈

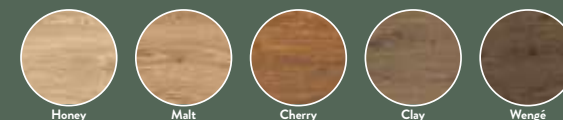

Honey

Malt

Cherry

Clay

Wengé

74_ ARTWOOD

30x180 . 11³/₈ x 70³/₈
40x120 . 15³/₈ x 47³/₈
30x120 . 11³/₈ x 47³/₈



Landhaus

Natur

Alpin

Scottish

Timber

76_ EICHE

30x180 . 11³/₈ x 70³/₈
40x120 . 15³/₈ x 47³/₈
30x120 . 11³/₈ x 47³/₈
20x120 . 7³/₈ x 47³/₈



Cognac

Cinnamon

Cloud

78_ MY SPACE

40x120 . 15³/₈ x 47³/₈
30x120 . 11³/₈ x 47³/₈



Stonewash

Silver

80_ TIME DESIGN

40x120 . 15³/₈ x 47³/₈
30x120 . 11³/₈ x 47³/₈

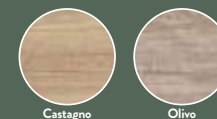

Castagno

Olivo

82_ QUERCUS **NoviBellPRO**

40x120 . 15³/₈ x 47³/₈

NORDIC WOOD

30x180 11^{13/16}x70^{7/8} - 30x120 11^{13/16}x47^{1/4} - 60x120 23^{5/8}x47^{1/4} - 60x60 23^{5/8}x23^{5/8}



WALNUT 30x180



WOOD



BLONDE BACCHETTE*



BLONDE

30x180 / 30x120 / 60x120* / 60x60*



WALNUT BACCHETTE*



WALNUT

30x180 / 30x120 / 60x120* / 60x60*



PEPPER BACCHETTE*



PEPPER

30x180 / 30x120 / 60x120* / 60x60*

20 MM 95 MM 9 MM

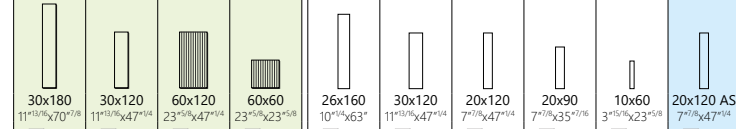

COLOR	30x180 11 ^{13/16} x70 ^{7/8} 01 1145	30x120 11 ^{13/16} x47 ^{1/4} 02 1135	60x120 23 ^{5/8} x47 ^{1/4} 01 1135	60x60 23 ^{5/8} x23 ^{5/8} 02 1120	26x160 10 ^{1/4} x63 ^{1/2} 03 1115	30x120 11 ^{13/16} x47 ^{1/4} 03 1100	20x120 7 ^{7/8} x47 ^{1/4} 04 1100	20x90 7 ^{7/8} x35 ^{7/16} 06 1060	10x60 3 ^{15/16} x23 ^{5/8} 12 1095	20x120 AS 7 ^{7/8} x47 ^{1/4} 04 1100
Blonde	NDW 318R	NDW 330R	NDW 342R	NDW 346R	NDW 36RT	NDW 33RT	NDW 31RT	NDW 32RT	NDW 360RT	NDW 31AS
Walnut	NDW 518R	NDW 530R	NDW 542R	NDW 546R	NDW 56RT	NDW 53RT	NDW 51RT	NDW 52RT	NDW 560RT	NDW 51AS
Pepper	NDW 118R	NDW 130R	NDW 142R	NDW 146R	NDW 16RT	NDW 13RT	NDW 11RT	NDW 12RT	NDW 160RT	NDW 11AS

i PEZZI SPECIALI
SPECIAL COORDINATED PIECES / PIÈCES SPÉCIALES COORDONNÉES / ZUSAMMENSTELLBARE FORMTEILE INFO PAG. 102

NORDIC WOOD FLAMED

30x120 11¹³/₁₆ x 47¹/₄



BLONDE FLAMED 30x120



WOOD



BLONDE FLAMED

30x120



WALNUT FLAMED

30x120



PEPPER FLAMED

30x120

20 MM 95 MM 9 MM

	30x120 11 ¹³ / ₁₆ x 47 ¹ / ₄	26x160 10 ¹ / ₂ x 63 ¹ / ₂	30x120 11 ¹³ / ₁₆ x 47 ¹ / ₄	20x120 7 ⁷ / ₈ x 47 ¹ / ₄
COLOR	02 1135	03 1115	03 1100	04 1100
Blonde Flamed	NDW 332R	NDW 306RT	NDW 303RT	NDW 301RT
Walnut Flamed	NDW 532R	NDW 506RT	NDW 503RT	NDW 501RT
Pepper Flamed	NDW 132R	NDW 106RT	NDW 103RT	NDW 101RT

i PEZZI SPECIALI
SPECIAL COORDINATED PIECES / PIÈCES SPÉCIALES COORDONNÉES / ZUSAMMENSTELLBARE FORMTEILE INFO PAG. 102

ARTWOOD

30x180 11¹³/₁₆"x70⁷/₈" - 40x120 15³/₄"x47¹/₄" - 30x120 11¹³/₁₆"x47¹/₄"



HONEY 30x180



WOOD

HONEY

30x180 / 40x120 / 30x120

MALT

30x180 / 40x120

CHERRY

40x120 / 30x120

CLAY

30x180 / 40x120 / 30x120

WENGÉ

40x120

COLOR	30x180 11 ¹³ / ₁₆ "x70 ⁷ / ₈ "	40x120 15 ³ / ₄ "x47 ¹ / ₄ "	30x120 11 ¹³ / ₁₆ "x47 ¹ / ₄ "	26x160 10 ¹ / ₄ "x63"	30x120 11 ¹³ / ₁₆ "x47 ¹ / ₄ "	20x120 7 ⁷ / ₈ "x47 ¹ / ₄ "	20x120 AS 7 ⁷ / ₈ "x47 ¹ / ₄ "
	01 1140	02 1125	02 1130	03 1110	03 1095	04 1095	04 1100
Honey	AWD 418R	AWD 42RT	AWD 430R	AWD 46RT	AWD 43RT	AWD 41RT	AWD 47AS
Malt	AWD 318R	AWD 32RT	-	AWD 36RT	AWD 33RT	AWD 31RT	AWD 37AS
Cherry	-	AWD 52RT	AWD 530R	AWD 56RT	AWD 53RT	AWD 51RT	-
Clay	AWD 218R	AWD 22RT	AWD 230R	AWD 26RT	AWD 23RT	AWD 21RT	AWD 27AS
Wengé	-	AWD 62RT	-	AWD 66RT	AWD 63RT	AWD 61RT	-

PEZZI SPECIALI
SPECIAL COORDINATED PIECES / PIÈCES SPÉCIALES COORDONNÉES / ZUSAMMENSTELLBARE FORMTEILE INFO PAG. 102

EICHE

30x180 11¹³/₁₆"x70⁷/₈" - 40x120 15³/₄"x47¹/₄" - 30x120 11¹³/₁₆"x47¹/₄" - 20x120 7⁷/₈"x47¹/₄"



LANDHAUS 30x180 - TIMBER 40x120



WOOD



LANDHAUS

30x180 / 40x120 / 20x120



NATUR

30x180 / 40x120 / 30x120 / 20x120



ALPIN

30x120 / 40x120 / 20x120



SCOTTISH

30x180 / 40x120 / 30x120 / 20x120



TIMBER

30x180 / 40x120 / 30x120 / 20x120

20 MM 95 MM 9 MM

	30x180 11 ¹³ / ₁₆ "x70 ⁷ / ₈ "	40x120 15 ³ / ₄ "x47 ¹ / ₄ "	30x120 11 ¹³ / ₁₆ "x47 ¹ / ₄ "	20x120 7 ⁷ / ₈ "x47 ¹ / ₄ "	26x160 10 ¹ / ₄ "x63"	16x160 6 ¹ / ₄ "x63"	30x120 11 ¹³ / ₁₆ "x47 ¹ / ₄ "	20x120 7 ⁷ / ₈ "x47 ¹ / ₄ "	20x120 AS 7 ⁷ / ₈ "x47 ¹ / ₄ "
	01 1140	02 1125	02 1130	02 1125	03 1110	04 1110	03 1095	04 1095	04 1100

COLOR	01 1140	02 1125	02 1130	02 1125	03 1110	04 1110	03 1095	04 1095	04 1100
Landhaus	ECH 418R	ECH 42RT	-	ECH 48RT	ECH 46RT	ECH 44RT	ECH 43RT	ECH 41RT	ECH 47AS
Natur	ECH 318R	ECH 32RT	ECH 330R	ECH 38RT	ECH 36RT	ECH 34RT	ECH 33RT	ECH 31RT	ECH37AS
Alpin	ECH 818R	ECH 82RT	-	ECH 88RT	ECH 86RT	ECH 84RT	ECH 83RT	ECH 81RT	-
Scottish	ECH 518R	ECH 52RT*	ECH 530R	ECH 58RT	ECH 56RT	ECH 54RT	ECH 53RT	ECH 51RT	ECH 57AS
Timber	ECH 618R	ECH 62RT*	ECH 630R	ECH 68RT	ECH 66RT	ECH 64RT	ECH 63RT	ECH 61RT	ECH 67AS

i PEZZI SPECIALI
SPECIAL COORDINATED PIECES / PIÈCES SPÉCIALES COORDONNÉES / ZUSAMMENSTELLBARE FORMTEILE INFO PAG. 102



MY SPACE

40x120 15^{13/16}x47^{1/4} - 30x120 11^{3/8}x47^{1/4}



COGNAC 40x120



WOOD



COGNAC

40x120 / 30x120



CINNAMON

40x120



CLOUD

40x120 / 30x120

20 MM 95 MM 9 MM

	20 MM		95 MM		9 MM					
	40x120 15 ^{13/16} x47 ^{1/4}	30x120 11 ^{3/8} x47 ^{1/4}	26x160 10 ^{1/4} x63 ^{1/2}	16x160 6 ^{1/4} x63 ^{1/2}	30x120 11 ^{3/8} x47 ^{1/4}	20x120 7 ^{7/8} x47 ^{1/4}	20x90 7 ^{7/8} x35 ^{3/16}	15x90 5 ^{7/8} x35 ^{3/16}	20x90 AS 7 ^{7/8} x35 ^{3/16}	
COLOR	02 1125	02 1130	03 1110	04 1110	03 1095	04 1095	06 1055	06 1055	06 1060	
Cognac	ESP 34RT*	ESP 330R	ESP 326R	ESP 316R	ESP 33RT	ESP 31RT	ESP 32RT	ESP 35RT	ESP 37AS	
Cinnamon	ESP 54RT	-	ESP 526R	ESP 516R	ESP 53RT	ESP 51RT	ESP 52RT	ESP 55RT	ESP 57AS	
Cloud	ESP 24RT*	ESP 230R	ESP 226R	ESP 216R	ESP 23RT	ESP 21RT	ESP 22RT	ESP 25RT	ESP 27AS	

PEZZI SPECIALI / SPECIAL COORDINATED PIECES / PIÈCES SPÉCIALES COORDONNÉES / ZUSAMMENSTELLBARE FORMTEILE INFO PAG. 102



pag. 117
info

TIME DESIGN

40x120 15^{7/16}x47^{1/4} - 30x120 11^{13/16}x47^{1/4}



STONEWASH 40x120



WOOD



STONEWASH

40x120 / 30x120



SILVER

40x120 / 30x120

	20 MM		9 MM					
	40x120 15 ^{7/16} x47 ^{1/4}	30x120 11 ^{13/16} x47 ^{1/4}	30x120 11 ^{13/16} x47 ^{1/4}	20x120 7 ^{7/8} x47 ^{1/4}	10x120 3 ^{15/16} x47 ^{1/4}	20x90 7 ^{7/8} x35 ^{7/16}	15x90 5 ^{7/8} x35 ^{7/16}	20x90 AS 7 ^{7/8} x35 ^{7/16}
COLOR	02 1125	02 1130	03 1095	04 1095	09 1105	06 1055	06 1055	06 1060
Stonewash	TMG 24RT	TMG 230R	TMG 23RT	TMG 21RT	TMG 20RT	TMG 22RT	TMG 25RT	TMG 27AS
Silver	TMG 14RT	TMG 130R	TMG 13RT	TMG 11RT	TMG 10RT	TMG 12RT	TMG 15RT	TMG 17AS

i PEZZI SPECIALI / SPECIAL COORDINATED PIECES / PIÈCES SPÉCIALES COORDONNÉES / ZUSAMMENSTELLBARE FORMTEILE INFO PAG. 102

QUERCUS NovaBell PRO
40x120 15^{7/16} x 47^{7/16}



OLIVO 40x120



WOOD



CASTAGNO

40x120



OLIVO

40x120



	20 MM	95 MM	9 MM		
	40x120 15 ^{7/16} x 47 ^{7/16}	26x160 10 ^{11/16} x 63 ^{1/2}	30x120 11 ^{13/16} x 47 ^{7/16}	20x120 7 ^{7/8} x 47 ^{7/16}	20x90 7 ^{7/8} x 35 ^{7/16}
COLOR	02 1125	03 1110	03 1095	04 1095	06 1055
Castagno	QU 52RT	QU 56RT	QU 53RT	QU 51RT	QU 59RT
Olivo	QU 72RT	QU 76RT	QU 73RT	QU 71RT	QU 79RT

PEZZI SPECIALI
SPECIAL COORDINATED PIECES / PIÈCES SPÉCIALES COORDONNÉES / ZUSAMMENSTELLBARE FORMTEILE INFO PAG. 102

METAL & CONCRETE

13

COLORS

4

SIZES
RECTIFIED

2

THICKNESS



Bronzo



Inox



Alluminio



Dark

86_FORGE

20 MM 80x80 . 31" / x 31" / 2



Beige



Grigio



Antracite

88_OPEN NovaBellPRO

20 MM 60x120 . 23" / x 47" / 4
80x80 . 31" / x 31" / 2
60x60 . 23" / x 23" / 6

30 MM 80x80 . 31" / x 31" / 2
60x60 . 23" / x 23" / 6

STONECREEK 100



Beige



Grigio Chiaro



Antracite

90_OXY

20 MM 100x100 . 39" / x 39" / 8
80x80 . 31" / x 31" / 2



Aorio



Grigio



Antracite

92_OVERLAND

20 MM 80x80 . 31" / x 31" / 2



FORGE

80x80 31^{11/2}x31^{11/2}



ALLUMINIO 80x80



09315
PORCELAIN
TILE



OUT
WALK

Porcelain
slabs



METAL & CONCRETE



BRONZO

80x80



INOX

80x80



ALLUMINIO

80x80



DARK

80x80

20
MM

9
MM

	80x80	100x100	80x80	60x120	30x120	60x60	30x60
	31 ^{11/2} x31 ^{11/2}	39 ^{9/16} x39 ^{9/16}	31 ^{11/2} x31 ^{11/2}	23 ^{5/8} x47 ^{11/16}	11 ^{11/16} x47 ^{11/16}	23 ^{5/8} x23 ^{5/8}	11 ^{11/16} x23 ^{5/8}
COLOR	01 1115	02 1100	02 1085	02 1085	03 1090	03 1065	07 1035
Bronzo	FRG 67RT	FRG 106R	FRG 68RT	FRG 62RT	FRG 63RT	FRG 60RT	FRG 66RT
Inox	FRG 87RT	-	FRG 88RT	FRG 82RT	FRG 83RT	FRG 80RT	FRG 86RT
Alluminio	FRG 17RT*	FRG 101R	FRG 18RT	FRG 12RT	FRG 13RT	FRG 10RT	FRG 16RT
Dark	FRG 97RT	-	FRG 98RT	FRG 92RT	FRG 93RT	FRG 90RT	FRG 96RT

i PEZZI SPECIALI
SPECIAL COORDINATED PIECES / PIÈCES SPÉCIALES COORDONNÉES / ZUSAMMENSTELLBARE FORMTEILE INFO PAG. 102



OPEN NovaBellPRO
80x80 31¹¹/₂x31¹¹/₂ - 60x120 23⁵/₈x47¹/₄

STONECREEK 100 60x60

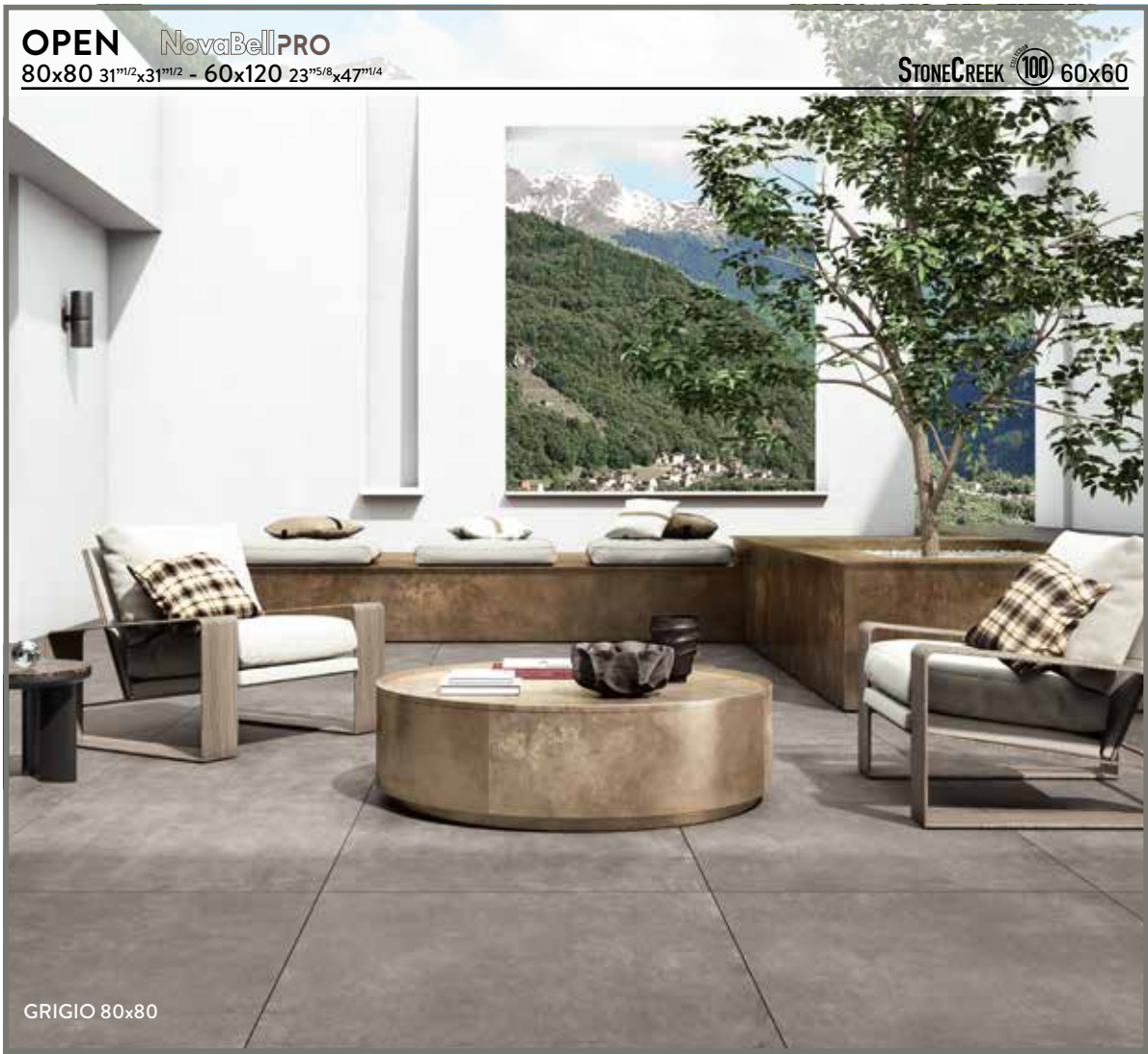

GRIGIO 80x80



METAL & CONCRETE



ANTRACITE

60x120 / 80x80 / 60x60 STONECREEK 100



3cm

80x80 / 60x60



GRIGIO

60x120 / 80x80 / 60x60 STONECREEK 100



BEIGE

60x120 / 80x80 / 60x60 STONECREEK 100

	20 MM		30 MM		9 MM				
	80x80	60x120	60x60	80x80	60x60	80x80	60x120	60x60	30x60
COLOR	01 1120	01 1125	02 1110	01 1150	02 1130	02 1075	02 1075	03 1065	07 1035
Antracite	OP 27RT	OP 29RT	Y00260*	OP 288R	OP 260R	OP 28RT	OP 22RT	OP 20RT	OP 26RT
Grigio	OP 17RT	OP 19RT	Y00160*	-	-	OP 18RT	OP 12RT	OP 10RT	OP 16RT
Beige	OP 47RT	OP 49RT	Y00460	-	-	OP 48RT	OP 42RT	OP 40RT	OP 46RT
Noce	-	-	Y00660	-	-	OP 68RT	OP 62RT	OP 60RT	OP 66RT
Nero	-	-	Y00960	-	-	OP 98RT	OP 92RT	OP 90RT	OP 96RT

PEZZI SPECIALI
SPECIAL COORDINATED PIECES / PIÈCES SPÉCIALES COORDONNÉES / ZUSAMMENSTELLBARE FORMTEILE INFO PAG. 102



OXY
100x100 39⁷/₈x39⁷/₈ - 80x80 31¹/₂x31¹/₂



GRIGIO CHIARO 80x80



METAL & CONCRETE



BEIGE

100x100



GRIGIO CHIARO

100x100 / 80x80



ANTRACITE

100x100 / 80x80

20 MM 9 MM

COLOR	100x100 39 ⁷ / ₈ x39 ⁷ / ₈ 01 1135	80x80 31 ¹ / ₂ x31 ¹ / ₂ 01 1120	100x100 39 ⁷ / ₈ x39 ⁷ / ₈ 02 1090	80x80 31 ¹ / ₂ x31 ¹ / ₂ 02 1075	60x120 23 ⁵ / ₈ x47 ¹ / ₄ 02 1075	60x60 23 ⁵ / ₈ x23 ⁵ / ₈ 03 1065	30x60 11 ¹³ / ₁₆ x23 ⁵ / ₈ 07 1035	60x60 AS 23 ⁵ / ₈ x23 ⁵ / ₈ 03 1070	30x60 AS 11 ¹³ / ₁₆ x23 ⁵ / ₈ 07 1040
Beige	FRY 124R	-	FRY 104R	FRY 48RT	FRY 42RT	FRY 40RT	FRY 46RT	FRY 41RT	FRY 45RT
Grigio Chiaro	FRY 121R	FRY 17RT	FRY 101R	FRY 18RT	FRY 12RT	FRY 10RT	FRY 16RT	FRY 11RT	FRY 15RT
Antracite	FRY 122R	FRY 27RT	FRY 102R	FRY 28RT	FRY 22RT	FRY 20RT	FRY 26RT	-	-

i PEZZI SPECIALI
SPECIAL COORDINATED PIECES / PIÈCES SPÉCIALES COORDONNÉES / ZUSAMMENSTELLBARE FORMTEILE INFO PAG. 102

OVERLAND

80x80 31^{1/2}x31^{1/2}"



AVORIO 80x80



METAL & CONCRETE



AVORIO

80x80



GRIGIO

80x80



ANTRACITE

80x80

20
MM

9
MM

COLOR	80x80 31 ^{1/2} x31 ^{1/2} " 01 1115	60x120 23 ^{5/8} x47 ^{1/4} " 02 1075	60x60 23 ^{5/8} x23 ^{5/8} " 03 1055	30x60 11 ^{13/16} x23 ^{5/8} " 07 1035	80x80 31 ^{1/2} x31 ^{1/2} " 02 1075	40x80 15 ^{7/8} x31 ^{1/2} " 02 1035	80x80 AS 31 ^{1/2} x31 ^{1/2} " 02 1075
Avorio	OVD 87RT	OVD 82RT	OVD 80RT	OVD 86RT	OVD 88RT	OVD 84RT	OVD 88AS
Grigio	OVD 17RT	OVD 12RT	OVD 10RT	OVD 16RT	OVD 18RT	OVD 14RT	OVD 18AS
Antracite	OVD 27RT	OVD 22RT	OVD 20RT	OVD 26RT	OVD 28RT	OVD 24RT	-

i PEZZI SPECIALI
SPECIAL COORDINATED PIECES / PIÈCES SPÉCIALES COORDONNÉES / ZUSAMMENSTELLBARE FORMTEILE INFO PAG. 102



pag. 117

RUSTIC

7

COLORS

3

SIZES
RECTIFIED



96_LUMIÈRE
60x90 . 23^{3/8} / x 35^{7/8} /
60x60 . 23^{3/8} / x 23^{3/8} /
MULTISIZE



98_MATERIA
60x60 . 23^{3/8} / x 23^{3/8} /
20 MM



LUMIÈRE

60x90 23¹⁵/₈x35¹⁷/₁₆ - 60x60 23¹⁵/₈x23¹⁵/₈ - MULTISIZE



AMBRA MULTISIZE



09315
PORCELAIN
TILE



OUT
WALK

Porcelain
slabs



RUSTIC



SABBIA

60x90 / 60x60 / MULTISIZE



AMBRA

60x90 / 60x60 / MULTISIZE



CENERE

60x90 / 60x60 / MULTISIZE

20
MM

9
MM

COLOR	01 1120	02 1115	top 1130	03 1105	03 1065	04 1085	06 1085	13 1085	26 1085	0,5 1095	04 1095	06 1095	13 1095	26 1095	0,5 1095
Sabbia	LMR 469R	LMR 460R	LMR M433	LMR 455R	LMR 45RT	LMR 446N	LMR 444N	LMR 424N	LMR 420N	LMR M44N	-	-	-	-	-
Ambra	LMR 369R	LMR 360R	LMR M333	LMR 355R	LMR 35RT	LMR 346N	LMR 344N	LMR 324N	LMR 320N	LMR M34N	LMR 346S	LMR 344S	LMR 324S	LMR 320S	LMR M34AS
Genere	LMR 269R	LMR 260R	LMR M233	LMR 255R	LMR 25RT	LMR 246N	LMR 244N	LMR 224N	LMR 220N	LMR M24N	LMR 246S	LMR 244S	LMR 224S	LMR 220S	LMR M24AS

PEZZI SPECIALI / SPECIAL COORDINATED PIECES / PIÈCES SPÉCIALES COORDONNÉES / ZUSAMMENSTELLBARE FORMTEILE INFO PAG. 102

MATERIA

60x60 23⁷⁵/₈ x 23⁷⁵/₈



ROSATO 60x60



RUSTIC



CHIARO

60x60



ROSSO

60x60



ROSATO

60x60



GRIGIO

60x60

20
MM

9
MM

COLOR	60x60 23 ⁷⁵ / ₈ x 23 ⁷⁵ / ₈	60x60 23 ⁷⁵ / ₈ x 23 ⁷⁵ / ₈	30x30 11 ¹⁵ / ₈ x 11 ¹⁵ / ₈	15x30 5 ⁷ / ₈ x 11 ¹⁵ / ₈	15x15 5 ⁷ / ₈ x 5 ⁷ / ₈	6x25 2 ³ / ₈ x 9 ¹⁵ / ₈	30x30 11 ¹⁵ / ₈ x 11 ¹⁵ / ₈
Rosato	MAT 56RT	MAT 560N	MAT 530N	MAT 515N	MAT 510N	MAT 562N	MAT 53AS
Rosso	MAT 66RT	MAT 660N	MAT 630N	MAT 615N	MAT 610N	MAT 662N	MAT 63AS
Chiario	MAT 86RT	MAT 860N	MAT 830N	MAT 815N	MAT 810N	MAT 862N	MAT 83AS
Grigio	MAT 16RT	-	MAT 130N	MAT 115N	MAT 110N	-	MAT 13AS

PEZZI SPECIALI
SPECIAL COORDINATED PIECES / PIÈCES SPÉCIALES COORDONNÉES / ZUSAMMENSTELLBARE FORMTEILE INFO PAG. 102

NOVABELL PROJECTS

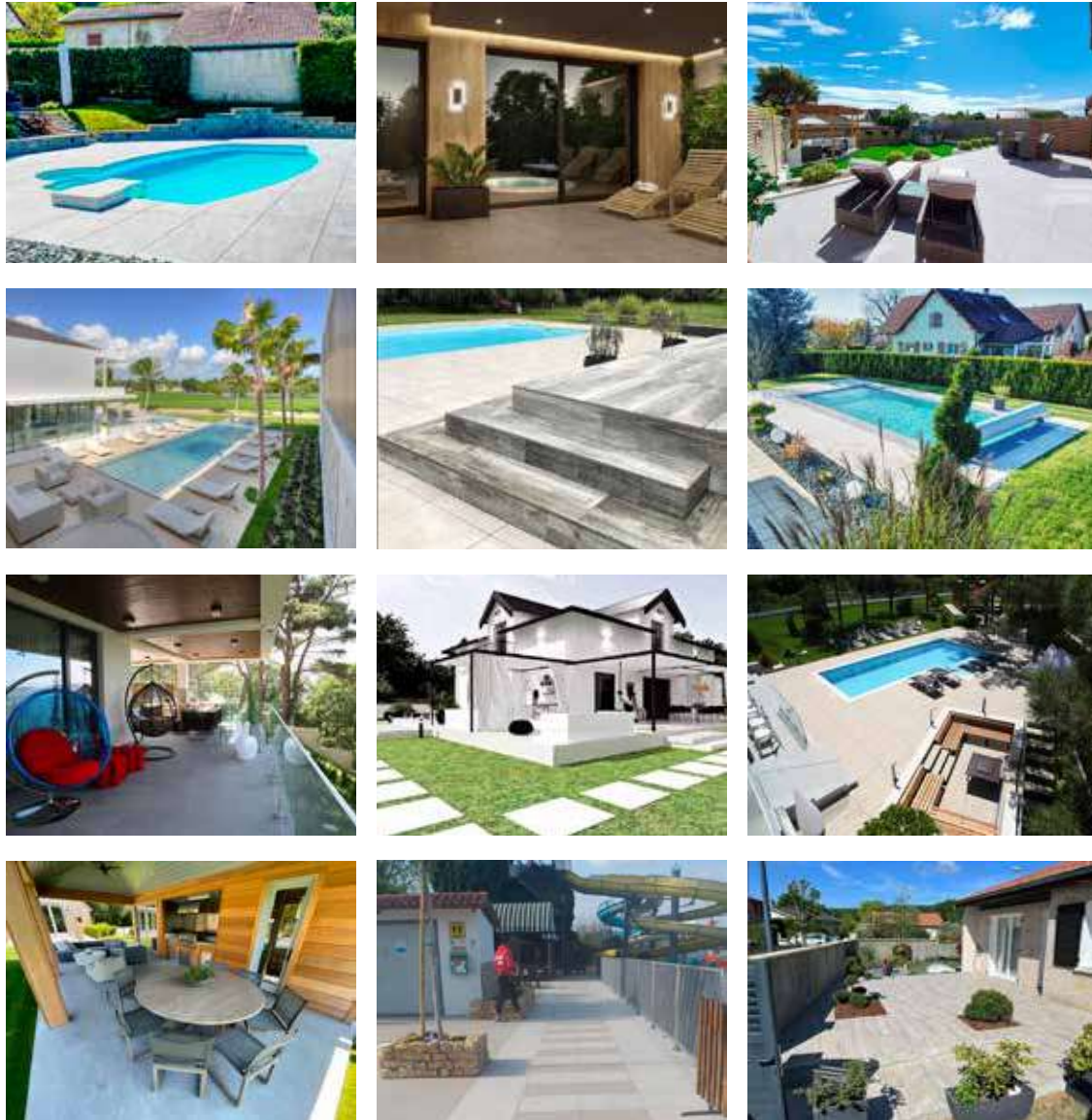

AROUND THE WORLD

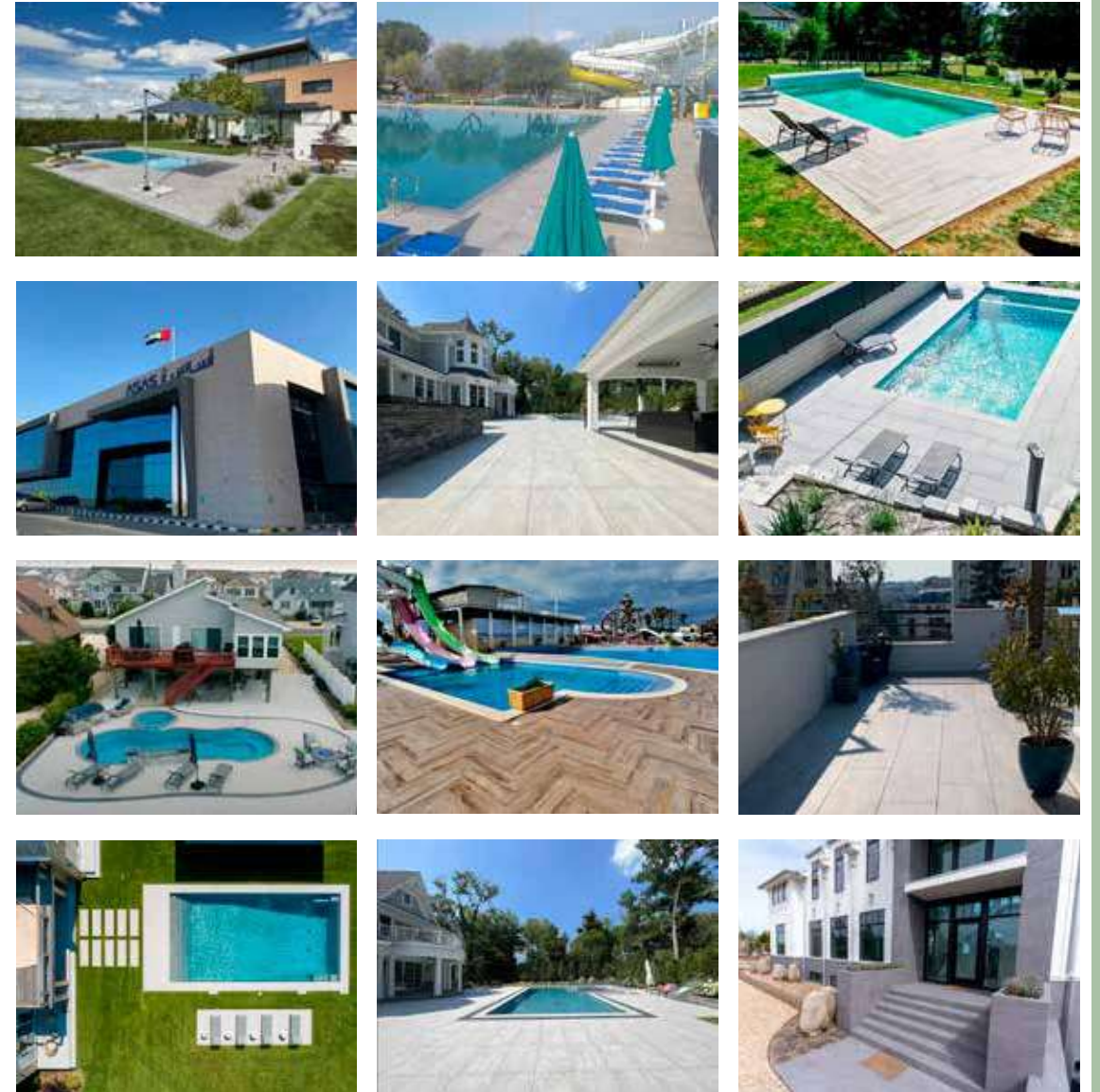

SLAB FOR STEPS

R11 A+B+C

IMBALLI E PESI / PACKAGING AND WEIGHTS EMBALLAGES ET POIDS / VERPACKUNGEN UND GEWICHTE

LASTRE PER GRADINI SLAB FOR STEPS DALLES POUR MARCHES STUFENPLATTEN		COLLECTION												
DESCRIZIONE	FP	Artwood	Aspen	Davos	Eiche	Landstone	Lounge	Lumière	Maxima	Norgestone	Oxy	Stone Box Dolomia	Stone Box Paved	Thermae
Gradino Monografico 60x180x2	01 681		APN 180MO							NST 180MO				
Gradino Monografico 60x120x2	01 673		APN 120MO	DVS 120MO		LST 120MO	LNG 120MO	LMR 120MO	MXM 120MO	NST 120MO		SBD 120MO	SBA 120MO	TRM 120MO
Gradino Monografico 60x90x2	01 676		APN 90MO	DVS 90MO		LST 90MO	LNG 90MO	LMR 90MO		NST 90MO				TRM 90MO
Gradino Monografico 100x100x2	01 681		APN 100MO			LST 100MO	LNG 90MO				FRY 100MO			TRM 100MO
Gradino L17 42x180x17	01 682		APN 180MX							NST 180MX				
Gradino L17 42x120x17	01 680	AWD 120MX	APN 120MX	DVS 120MX	ECH 120MX	LST 120MX	LNG 120MX	LMR 120MX	MXM 120MX	NST 120MX		SBD 120MX	SBA 120MX	TRM 120MX
Gradino L17 42x90x17	01 673		APN 90MX	DVS 90MX		LST 90MX	LNG 90MX	LMR 90MX		NST 90MX				TRM 90MX
Gradino L17 82x100x17	01 682		APN 100MX			LST 100MX	LNG 100MX				FRY 100MX			TRM 100MX
Gradino Elle 60x180x6,5	01 682		APN 180EL							NST 180EL				
Gradino Elle 60x120x6,5	01 680	AWD 120EL	APN 120EL	DVS 120EL	ECH 120EL	LST 120EL	LNG 120EL	LMR 120EL	MXM 120EL	NST 120EL		SBD 120EL	SBA 120EL	TRM 120EL
Gradino Elle 60x90x6,5	02 673		APN 90EL	DVS 90EL		LST 90EL	LNG 90EL	LMR 90EL		NST 90EL				APN 90EL
Gradino Elle 100x100x6,5	01 682		APN 100EL			LST 100EL	LNG 100EL				FRY 100EL			TRM 100EL
Toro Gradino 60x180x2	01 670		APN 180TO							NST 180TO				
Toro Gradino 60x120x2	01 664	AWD 120TO	APN 120TO	DVS 120TO	ECH 120TO	LST 120TO	LNG 120TO	LMR 120TO	MXM 120TO	NST 120TO		SBD 120TO	SBA 120TO	TRM 120TO
Toro Gradino 60x90x2	02 656		APN 90TO	DVS 90TO		LST 90TO	LNG 90TO	LMR 90TO		NST 90TO				TRM 90TO
Toro Gradino 100x100x2	01 670		APN 100TO			LST 100TO	LNG 100TO				FRY 100TO			TRM 100TO
COLORI DISPONIBILI COLOURS AVAILABLES COULEURS DISPONIBLES VERFÜGBARE FARBEN		Clay	Basalt	Grigio	Timber	Gravel	Shadow	Cenere	Dark Brown	Dark Grey	Antracite	Dolomia Grey	Paved Basalt	Storm
		Malt	Rock Grey	Antracite	Scottish	Taupe	Steel	Ambra	Grigio	Taupe	Beige	Dolomia Gold	Paved Grey	Caramel
		Sand Moon				Clay	Pearl	Sabbia	Sand				Paved Brown	Honey

Novabell offre un'ampia gamma di lastre pre-finite in 20mm di varie dimensioni per realizzare in opera gradini e scale su misura. NovaBell offers a wide range of 20mm pre-finished slabs in various sizes of create customized steps and stairs on site.

Novabell offre una large gamme de dalles préfini en 20mm de différentes dimensions pour réaliser sur place marches et et escaliers sur mesure.

NovaBell bietet ein großes Angebot an vorgefertigten 20 mm starken Platten in verschiedenen Größen für die Herstellung von Stufen und maßgeschneiderte treppe.

FORMATO	cm	20 MM										30 MM					
		100x100	80x80	60x180	30x180	60x90	Multisize	60x120	40x120	30x120	20x120	60x60	30x60	80x80	40x80	60x60	
PACKING BOX	pz.	1	1	1	1	1	1 cp.	1	2	2	2	2	3	1	2	2	
	m2	1,00	0,64	1,08	0,54	0,54	1,62	0,72	0,96	0,72	0,48	0,72	0,54	0,64	0,64	0,72	
	kg	43,0	27,6	46,8	23,8	23,1	71,7	31,4	41,6	30,6	20,6	31,0	23,7	45,2	45,2	49,3	
PALLET	box	21	40	22	42	48	14 cp.	33	24	36	40	32	40	24	24	22	
	m2	21,00	25,60	23,76	22,68	25,92	22,68	23,76	23,04	25,92	19,20	23,04	21,60	15,36	15,36	15,84	
	kg	903	1104	1030	1000	1109	1004	1036	998	1102	824	992	948	1085	1085	1085	
Pietra Stone	ALLBLACK																
	ASPEN																
	DAVOS																
	IMPERIAL VENICE																
	KINGSTONE																
	LANDSTONE																
	LOUNGE																
	MAXIMA																
	NORGESTONE																
	SOVEREIGN																
	STONE BOX	Blue Stone															
		Dolomia															
		Giava															
Paved																	
Urbe																	
Thermae																	
Metallo & Cemento Metal & Concrete	FORGE																
	OPEN																
	OVERLAND																
	OXY																
Legno Wood	ARTWOOD																
	EICHE																
	MY SPACE																
	NORDIC WOOD																
	QUERCUS																
TIME DESIGN																	
Rustico Rustic	LUMIÈRE																
	MATERIA																
SIZE	inch	39"×39"±0,8	31"×31"±0,8	23"×70"±0,8	11"×1/2"×70"±0,8	23"×35"±0,8	Multisize	23"×47"±0,8	15"×47"±0,8	11"×1/2"×47"±0,8	7"×47"±0,8	23"×23"±0,8	11"×1/2"×23"±0,8	31"×31"±0,8	15"×31"±0,8	23"×23"±0,8	
PACKING BOX	pcs	1	1	1	1	1	1 cp.	1	2	2	2	2	3	1	2	2	
	Sqft	10,76	6,89	11,62	5,81	5,81	17,44	7,75	10,33	7,75	5,16	7,75	5,81	6,89	6,89	7,75	
	Lbs	94,8	60,9	103,2	52,5	51,0	158,1	69,2	91,7	67,5	45,4	69,3	52,3	99,6	99,6	108,7	
PACKING PALLET	box	21	40	22	42	48	14 cp.	33	24	36	40	32	40	24	24	22	
	Sqft	430,55	275,55	235,50	244,13	278,88	244,13	255,75	248,00	279,00	206,67	248,00	232,50	165,33	165,33	170,50	
	Lbs	1990	2436	2270	2205	2448	2213	2214	2200	2430	1816	2186	2093	2392	2392	2392	

POSA A SECCO SU ERBA* DRY INSTALLATION ON GRASS

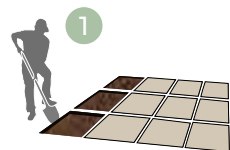
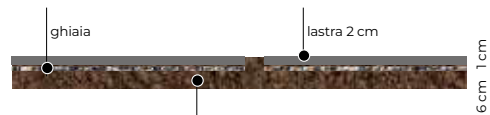

IT PREPARAZIONE
Appoggiare le lastre "in prova" verificandone la disposizione ottimale. Con una vanga, incidere il terreno lungo il perimetro di ogni lastra. Togliere le lastre e in corrispondenza rimuovere il terreno per circa 6 cm.

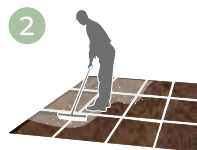

SOTTOFONDO
Nelle aree scavate, posizionare uno strato di ghiaietto (grana 0,5-1 cm) per livellare il sottofondo e renderlo stabile.

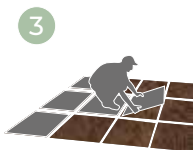

POSA
Appoggiare le lastre assicurandosi che il piano di calpestio sia a livello del terreno o leggermente più basso.

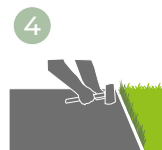

FUGA
Se necessario, compattare il terreno lungo i bordi delle lastre con un martelletto in gomma.

EN PREPARATION
Try out the arrangement of the slabs on the grass to find the best layout. Cut the ground around the edge of each slab with the aid of a spade. Remove the slabs and dig out soil to a depth of about 6 cm in the installation position of each one.

SUBSTRATE
Add a layer of fine gravel (particle size 0,5-1 cm) in the hole made for each slab to provide a level, firm substrate.

INSTALLATION
Put the slabs in place, making sure that the top face is level with or slightly below the surface of the ground.

JOINTS
If necessary, compact the ground around the edges of the slabs with a rubber hammer.

FR PRÉPARATION
Déposer les dalles pour « tester » leur disposition et trouver la meilleure. Délimiter le périmètre de chaque dalle avec une bêche. Retirer les dalles et, à leur place, creuser le sol sur 6 cm de profondeur.

SUPPORT DE POSE
Dans les endroits creusés, mettre une couche de gravier (granulométrie 0,5-1 cm) pour niveler le support de pose et le stabiliser.

POSE
Déposer les dalles en veillant à ce que la surface de piétinement soit exactement au même niveau que le sol ou à un niveau légèrement inférieur.

JOINTS
Le cas échéant, tasser le sol tout autour des dalles avec un maillet en caoutchouc.

DE VORBEREITUNG
Die Platten probeweise verlegen und ihre optimale Anordnung überprüfen. Mit einem Spaten um den äußeren Plattenrand eine Furche im Boden ziehen. Die Platten entfernen und den Bereich 6 cm tief ausheben.

UNTERGRUND
Den ausgehobenen Bereich mit einer Splittschicht (Korngröße 0,5-1 cm) füllen, um einen ebenen und stabilen Untergrund zu schaffen.

VERLEGUNG
Die Platten auf das Splittbett auflegen und darauf achten, dass sich die Trittebene auf bzw. etwas unterhalb der Erdoberfläche befindet.

VERFUGUNG
Das Erdreich entlang der Plattenränder ggf. mit einem Gummihammer verdichten.

* **DISCLAIMER.** Tutte le presenti note sulla posa sono da intendere come informazioni generiche sulle possibili applicazioni e utilizzazioni del rivestimento ceramico. Nel caso concreto le scelte sulla modalità di posa necessitano di adeguate valutazioni da parte di professionisti qualificati, in base alle caratteristiche specifiche del contesto, del tipo di traffico e della normativa vigente. NovaBell pertanto declina ogni responsabilità.

DISCLAIMER. All the installation advice which follows is provided as general guidance on the possible applications and uses of ceramic coverings. In each actual case, installation methods must be chosen on the basis of careful assessment by skilled professionals, considering the specific characteristics of the context, the type of traffic and the regulatory framework. NovaBell therefore declines all responsibility.

CLAUDE DE NON-RESPONSABILITÉ. Les remarques et observations ci-après doivent être considérées comme des informations de nature générale sur les applications et utilisations possibles du revêtement céramique. Dans la pratique, la méthode de pose doit être évaluée par des professionnels qualifiés, selon les caractéristiques du projet, le type de trafic et les normes en vigueur. Dès lors, NovaBell décline toute responsabilité.

DISCLAIMER. Diese Verlegehinweise gelten als allgemeine Informationen zu den Anwendungs- und Nutzungsmöglichkeiten von keramischen Belägen. Die Wahl des Verlegeverfahrens ist im Einzelfall mit dem Fachmann auf der Grundlage des Einsatzumfeldes, der Beanspruchung und der geltenden Vorschriften abzustimmen. NovaBell übernimmt keine Haftung.

POSA A COLLA* LAYING WITH ADHESIVES

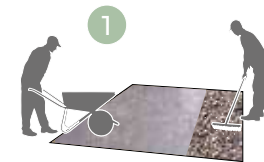
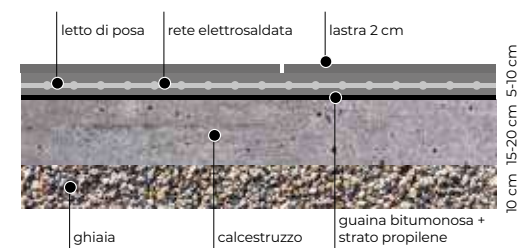

IT PREPARAZIONE
Stendere il letto di posa di 5-10 cm, posizionando una rete elettrosaldata circa alla metà dello spessore. Prevedere una adeguata pendenza (indicativamente il 2%). Rispettare scrupolosamente i tempi di maturazione e stabilizzazione.

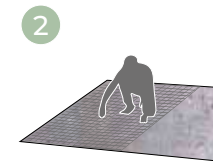

SOTTOFONDO
Stendere il letto di posa di 5-10 cm, posizionando una rete elettrosaldata circa alla metà dello spessore. Prevedere una adeguata pendenza (indicativamente il 2%). Rispettare scrupolosamente i tempi di maturazione e stabilizzazione.

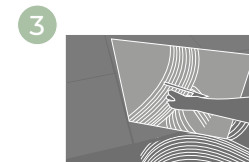

POSA
Incollare le lastre con il metodo della doppia spalmatura, stendendo uno strato di colla sul sottofondo e sulla lastra. Utilizzare un adesivo per esterni ad alte prestazioni, specifico per gres porcellanato, seguendo le indicazioni del produttore. Prevedere i necessari giunti di dilatazione secondo le esigenze specifiche del contesto.

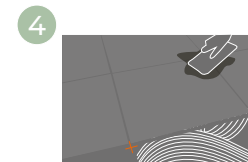

FUGA
Predisporre le fughe utilizzando apposti distanziali di almeno 4-5 mm. Il riempitivo per fughe deve essere un prodotto specifico per applicazioni in esterno, applicato secondo le prescrizioni del produttore. Effettuare la pulizia dopo posa con apposito detergente per rimuovere ogni residuo di adesivo e fugante.

EN PREPARATION
Prepare a compact layer of gravel and hard core at least 10 cm deep (loose stone foundation) and cast a layer of concrete with a suitable thickness (usually about 15-20 cm) on top. If water proofing is required, a layer of bitumen membrane can be added, with a polyethylene separator sheathing on top.

SUBSTRATE
Create a substrate of 5-10 cm with a rebar mesh about halfway through its depth. Ensure a suitable pitch (about 2%). Comply strictly with curing and stabilisation times.

INSTALLATION
Glue the slabs in place, coating both the back of the slab and the substrate. Use a high-performance outdoor adhesive specifically for porcelain stoneware and follow the producer's instructions. Provide expansion joints as required by the specific context.

JOINTS
Create joints of at least 4-5 mm with the aid of suitable spacers. The joint filler must be a specific product for outdoor use, applied in accordance with the producer's instructions. Clean after installation with a specific cleaner to remove all traces of adhesive and grout.

FR PRÉPARATION
Mettre une couche compacte de gravier et pierraille d'au moins 10 cm d'épaisseur (vide sanitaire), sur laquelle couler la bonne épaisseur de béton (approximativement 15-20 cm). Si l'imperméabilisation est nécessaire, appliquer un feutre bitumé avec, au-dessus, une couche de séparation en polyéthylène.

SUPPORT DE POSE
Réaliser le lit de pose sur une épaisseur de 5-10 cm et positionner un treillis soudé environ à la moitié de l'épaisseur. Prévoir une inclinaison appropriée (approximativement 2%). Respecter scrupuleusement les temps de prise et de stabilisation.

POSE
Coller les dalles selon la méthode du double encollage, en appliquant une couche de colle sur le support de pose et une couche de colle sur la dalle. Utiliser un mortier-colle pour extérieur à haute performance, spécialement fait pour le grès cérame, en observant les instructions du fabricant. Prévoir les joints de dilatation nécessaires selon les exigences spécifiques du projet.

spécialement mis au point pour les applications en extérieur, en observant les instructions du fabricant. Effectuer le nettoyage après pose avec un détergent prévu à cet effet pour éliminer tous les résidus de mortier-collé et mortier-joint.

DE VORBEREITUNG
Eine kompakte, mindestens 10 cm dicke Kies- und Splittschicht (Frostschuttschicht) aufschütten, auf die ein Betonbett geeigneter Dicke (ca. 15-20 cm) aufgebracht wird. Für eine ggf. notwendige Abdichtung werden Bitumenabdichtungsbahnen verklebt, auf die eine Trennschicht aus Polyethylen folgt.

UNTERGRUND
Das Kleberbett mit einer Dicke von 5-10 cm auftragen. Auf halber Höhe des Kleberbetts eine Gittermatte einrollen. Es muss auf ein angemessenes Gefälle (ca. 2 %) geachtet werden. Aushärtungs- und Stabilisierungszeit sind streng zu beachten.

VERLEGUNG
Die Platten im Buttering-Floating-Verfahren, bei dem der Kleber auf dem Untergrund und der Plattenrückseite aufgetragen wird, verkleben. Einen Spezialkleber für Feinsteinzeug, der höchste Leistungsanforderungen erfüllt und für den Außenbereich geeignet ist, gemäß den Herstellerangaben verwenden. Gemäß den spezifischen Umgebungsbedingungen die notwendigen Dehnungsfugen berücksichtigen.

VERFUGUNG
Die Fliesen unter Verwendung von Fugenkreuzen mit einer Fugenbreite von mindestens 4-5 mm verlegen. Gemäß den Herstellerangaben mit einem Spezialmörtel für Außenbereiche verfugen. Nach der Verlegung mit einem hierfür geeigneten Reinigungsmittel alle Klebe- und Verfugrückstände entfernen.

POSA A SECCO SU GHIAIA DRY INSTALLATION ON GRAVEL

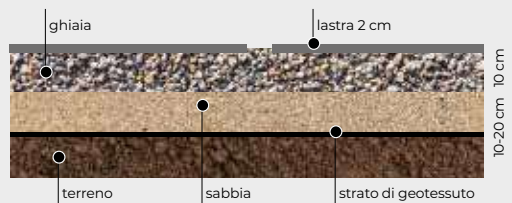

1 **PREPARAZIONE**
In caso di posa su terreno, asportare il terreno per uno spessore di 10-20cm; se il pavimento è adiacente a una zona erbosa o comunque non compatta è consigliabile installare una filetta di contenimento a vista o a scomparsa (in pietra, metallo o pvc). Livellare e compattare il piano utilizzando sabbia o terriccio. Il posizionamento di uno strato di geotessuto permette di separare il sottofondo dal terreno ed evita l'insorgenza di vegetazione infestante.

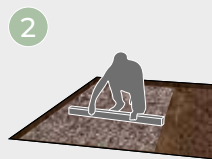

2 **SOTTOFONDO**
Posizionare uno strato di ghiaia indicativamente di 10cm (lo spessore migliora il drenaggio) utilizzando ghiaietto a granulometria media (circa 30-40 mm). Livellare con una staggia e compattare accuratamente, eventualmente utilizzando una piastra compattatrice meccanica. In caso di posa a ghiaia su massetto opportunamente impermeabilizzato, è sufficiente uno strato inferiore di ghiaia.

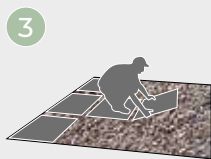

3 **POSA**
Appoggiare le lastre secondo il piano di posa, in caso di posa ravvicinata è possibile utilizzare distanziali specifici, lasciando sempre una fuga minima di 4-5mm. Per eventuali aggiustamenti si può utilizzare un martelletto in gomma bianca.

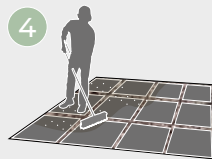

4 **FUGA**
Per fughe di 4-10mm è consigliabile l'uso di un fugante in sabbia polimerica, compatta ma drenante, specifica per questi impieghi. In alternativa lasciarle vuote o riempire lo spazio con sabbia lavata. In caso di lastre con posa molto distanziata (4-5cm) gli spazi sono riempiti con ghiaia di adeguata granulometria.

EN PREPARATION
If laying on soil, dig out to a depth of 10-20cm; if the paving adjoins grass or any other uncompact surface, a visible or concealed containing kerb (in stone, metal or PVC) should be used. Level and compact the surface with sand or soil. A geotextile layer will separate the substrate from the soil and prevent the growth of weeds.

EN SUBSTRATE
Lay a level of fine gravel (particle size 30-40 mm) about 10 cm deep (a deeper layer means better drainage). Level with a straightedge and compact thoroughly, with a mechanical compactor if necessary. When installing on gravel over a waterproofed screed, a thinner layer of gravel is sufficient.

EN JOINTS
Joints of 4-10 mm should be filled with a polymer sand filler, specifically for installations of this kind, which is compact but still allows drainage. Otherwise, leave the gaps empty or fill them with washed sand. When slabs are installed with very large gaps (4-5 cm), these should be filled with gravel of suitable particle size.

FR PRÉPARATION
Pour la pose en pleine terre, creuser le sol sur 10-20 cm de profondeur. Si le carrelage se trouve à proximité d'une zone d'herbe ou, quoi qu'il soit, d'une zone non compacte, il est recommandé d'installer une structure de confinement apparente ou invisible (en pierre, en métal ou en PVC). Nivelier et tasser la surface de pose avec du sable ou du terreau. L'application d'un géotextile permet de séparer le support du sol naturel et empêche la végétation d'envahir le carrelage.

FR SUPPORT DE POSE
Mettre une couche de gravier d'approximativement 10 cm d'épaisseur (l'épaisseur optimise le drainage). Utiliser un gravier de moyenne granulométrie (environ 30-40 mm). Nivelier avec une règle à niveau, puis bien tasser avec, le cas échéant, une plaque mécanique. Pour la pose sur chape correctement imperméabilisée, une plus petite couche de gravier suffit.

FR POSE
Déposer les dalles selon le schéma de pose. Si les dalles sont posées très près l'une de l'autre, il est possible d'utiliser des crochets spécifiques, en veillant toujours à laisser un espace minimum de 4-5 mm entre les dalles. Utiliser un maillet en caoutchouc blanc pour les éventuelles rectifications de niveau.

FR JOINTS
Pour les joints de 4-10 mm, il est recommandé d'utiliser du sable polymère, compact mais drainant, tout spécialement prévu pour ce genre de pose. Autrement, laisser les joints vides ou les remplir avec du sable lavé. Si les dalles sont posées très loin l'une de l'autre (4-5 cm), remplir les joints avec du gravier de granulométrie appropriée.

DE VORBEREITUNG
Bei Verlegung auf dem Erdboden ist eine 10-20 cm tiefe Aushebung erforderlich. Wenn der Belag an eine Grünfläche bzw. eine unverfestigte Fläche angrenzt, ist eine erhöhte oder bodenebene Umfriedung aus Stein, Metall oder PVC anzulegen. Den Untergrund mit Sand oder Erdreich nivellieren und verdichten. Eine Abdeckung mit Wurzelvlies trennt den Belaguntergrund vom Erdreich und verhindert das Durchwachsen von Unkraut.

DE UNTERGRUND
Eine etwa 10 cm dicke Kiesschicht (für eine bessere Drainage) mittlerer Korngröße (30-40 mm) aufschütten. Mit einer Latte abziehen und gründlich, ggf. mit einer Rüttelplatte verdichten. Bei Verlegung im Kiesbett auf entsprechend abgedichtetem Estrich ist eine dünnere Kiesschicht hinreichend.

DE VERLEGUNG
Die Platten entsprechend dem Verlegeplan auflegen. Bei nah aneinander liegenden Platten sind spezielle Fugenkreuze zu verwenden und soll stets eine Fugenbreite von mindestens 4-5 mm gewahrt werden. Etwaige Korrekturen können mit einem Gummihammer vorgenommen werden.

DE VERFUGUNG
Für 4-10 mm breite Fugen wird ein kompakter und zugleich wasserableitender Polymerfugensand empfohlen. Andernfalls die Fugen leer lassen oder mit gewaschenem Sand verfüllen. Bei großflügig verlegten Platten (4-5 cm) sind die Plattenzwischenräume mit Kies von entsprechender Körnung zu verfüllen.

POSA A SECCO SU SABBIA DRY INSTALLATION ON SAND

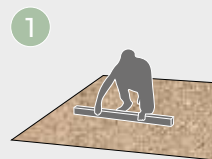
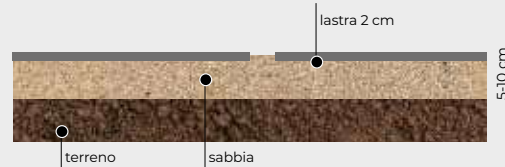

1 **PREPARAZIONE**
Livellare la zona da pavimentare aiutandosi con una staggia.

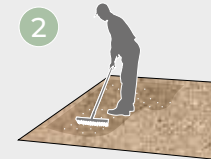

2 **SOTTOFONDO**
È consigliabile la presenza di uno strato di sabbia di almeno 5-10 cm.

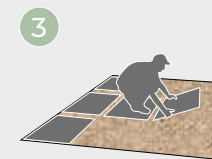

3 **POSA**
Posizionare le lastre, aiutandosi con distanziali o con una barra per allinearle perfettamente le fughe regolare la planarità controllando con una staggia. Per eventuali aggiustamenti si può utilizzare un martelletto in gomma bianca.

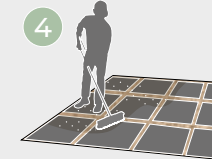

4 **FUGA**
Riempire con sabbia gli spazi tra le lastre per evitare il pericolo di inciampi.

i Riposizionabile. Per traffico pedonale o con cicli. Per la posa non occorrono specifiche competenze e attrezzature. In caso di possibile uso senza calzature, utilizzare esclusivamente colori chiari.

Allows repositioning. For use by pedestrians or cyclists. No specific skills or equipment are required for installation. If barefoot use is expected, use light colours only.

Repositionnable. Pour trafic de piétons ou vélos. La pose n'exige pas de compétences ni d'outils spécifiques. En cas d'utilisation sans chaussures, n'utiliser que des couleurs claires.

Umverlegbar. Für den Fußgänger- und Fahrradverkehr geeignet. Für die Verlegung sind keine besonderen Kenntnisse und Werkzeuge erforderlich. Bei eventueller Barfußnutzung sind helle Farben empfehlenswert.

EN PREPARATION
Level the zone for paving with the aid of a straightedge.

EN SUBSTRATE
A layer of sand at least 5-10 cm deep is recommended.

EN INSTALLATION
Position the slabs with the aid of spacers or a bar so that the joints are perfectly aligned, and level the surface with the aid of a straightedge. A white rubber hammer can be used for any adjustments.

EN JOINTS
Fill the gaps between slabs with sand to prevent the risk of tripping.

FR PRÉPARATION
Avec une règle à niveau, niveler l'endroit où les dalles seront posées.

FR SUPPORT DE POSE
Il est préférable que la couche de sable ait au moins 5-10 cm d'épaisseur.

FR POSE
Positionner les dalles à l'aide de crochets ou avec une barre pour aligner parfaitement les joints, et contrôler l'horizontalité avec une règle à niveau. Utiliser un maillet en caoutchouc blanc pour les éventuelles rectifications de niveau.

FR JOINTS
Remplir de sable les espaces entre les dalles pour prévenir les trébuchements.

DE VORBEREITUNG
Den vorgesehenen Belagbereich mit einer Latte nivellieren.

DE UNTERGRUND
Es wird ein Sandbett mit einer Dicke von mindestens 5-10 cm empfohlen.

DE VERLEGUNG
Die Platten verlegen. Die Platten sind mit Hilfe von Fugenkreuzen oder einem Stab auszurichten. Die Ebenheit mit einer Latte prüfen. Etwaige Korrekturen können mit einem Gummihammer vorgenommen werden.

DE VERFUGUNG
Die Fugen zwischen den Platten mit Sand verfüllen, um die Stolpergefahr zu unterbinden.

POSA SOPRAELEVATA * INSTALLATION AS A RAISED PAVING

POSE SURÉLEVÉE VERLEGUNG AUF STELZLAGERN

20
MM

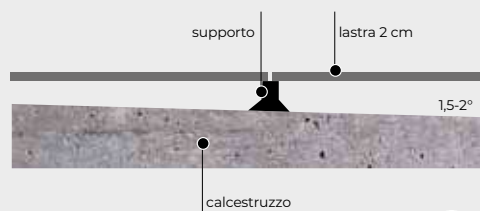

Sistema leggero e funzionale, con lastre ispezionabili.
Migliora l'isolamento termico e permette di alloggiare tubi e cavi.
A lightweight, convenient system, with slabs which can be lifted off for inspection.
It improves thermal insulation and is able to accommodate pipes and cables.
Système léger et pratique, avec espace technique facile à inspecter.
Optimise le calorifugeage et permet le passage des tuyaux et câbles.
Leichtes, praktisches System mit inspizierbaren Platten.
Verbessert die Wärmeisolierung und ermöglicht die Verlegung von Leitungen und Kabeln.

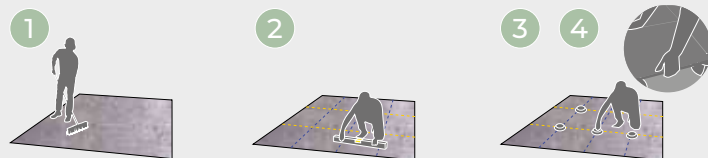

PREPARAZIONE
Per le valutazioni sul tipo di supporto (fissi, autoivelanti) e sulla altezza del piano di calpestio è indispensabile la consulenza di un esperto e/o della azienda fornitrice dei supporti. Nel calcolo della quantità di supporti e di eventuali accessori per la finitura perimetrale, occorre tener conto dello sfrido e della conformazione dell'area da pavimentare in funzione del modulo di posa.

SOTTOFONDO
Il sottofondo deve essere adeguatamente impermeabilizzato, avere le necessarie pendenze (1,5-2%) e idoneo sistema di raccolta delle acque. Il piano deve avere la portanza per sopportare il carico puntuale dei supporti.

POSA - Posizionare i supporti individuando il reticolato di posa ottimale, tenuto conto dell'adattamento del modulo rispetto allo spazio da pavimentare, evitando ritagli perimetrali inferiori a 10cm. Vi invitiamo a consultare la tabella di pagina 135.
FUGA - I supporti sono predisposti con un distanziale che lascia una fuga di 2-4 mm. Lo spazio rimane aperto permettendo il deflusso dell'acqua piovana nell'intercapedine.

AVVERTENZE

Avvertenza: rischio rottura. Nell'eventualità che un oggetto pesante cadesse su una lastra appoggiata su supporti, l'impatto concentrato da una determinata altezza potrebbe causare la rottura, creando un potenziale rischio per eventuali passanti. La tabella di pag. 119 suggerisce alcune misure cautelative, la cui idoneità specifica deve essere valutata da un professionista abilitato in base al contesto e alle normative locali.
Avvertenza: rischio sollevamento. In terrazze e pavimentazioni esterne posate in appoggio, è possibile che l'azione di un forte vento possa sollevare e muovere le lastre, con il pericolo di causare danni a cose o persone. NovaBell raccomanda di verificare con un professionista abilitato la tipologia di posa, le condizioni ambientali specifiche e le normative locali, adottando soluzioni idonee a evitare ogni rischio.

CAUTION

Caution: risk of breakage. In the event of a heavy item falling on a slab resting on pedestals, the concentrated impact of the object falling from some height could cause it to break, with a potential risk for anyone in the vicinity. The table on page 119 suggests some appropriate precautions, the specific suitability of which must be assessed by a qualified professional in relation to the context and local regulations.
Caution: risk of lifting. When outdoor patio coverings and pavings are installed without glue or fasteners, strong winds may lift and move the slabs, with the risk of personal injury or damage to property. NovaBell urges customers to check the installation method, specific weather conditions and local regulations with a qualified professional and adopt solutions which avoid all risks.

MISE EN GARDE

Mise en garde : risque de rupture. Si un objet lourd tombait sur une dalle reposant sur des plots, l'impact concentré de cette chute depuis une certaine hauteur pourrait en causer la rupture, créant ainsi un risque potentiel pour d'éventuels passants. Le tableau de la p. 119 propose certaines mesures de précaution, dont la conformité spécifique doit être évaluée par un professionnel habilité, en fonction du contexte et des réglementations locales.
Mise en garde : risque de soulèvement. Sur les terrasses et sols extérieurs posés en appui, les dalles peuvent être soulevées et déplacées sous l'effet de la force du vent, risquant ainsi de causer des dommages aux biens et aux personnes. NovaBell recommande de vérifier avec un professionnel habilité le type de pose, les conditions spécifiques de l'environnement ainsi que les réglementations locales, en adoptant des solutions adéquates permettant d'éviter tous les risques.

WARNUNG

Warnung: Bruchrisiko. Wenn ein schwerer Gegenstand aus einer bestimmten Höhe auf eine auf Stelzlager aufliegende Platte herabfällt, kann diese durch den konzentrierten Aufschlag brechen, was ein potentielles Risiko für zufällig anwesende Personen darstellt. Die Tabelle auf S. 119 enthält einige Vorsichtsmaßnahmen, die jeweils nach Beurteilung eines Fachmanns unter Berücksichtigung der Umgebungsbedingungen und örtlichen Bestimmungen anzuwenden sind.
Warnung: Risiko der Abhebung. Bei Terrassen und ungebunden verlegten Bodenbelägen im Außenbereich können sich die Platten durch Einwirkung von starkem Wind heben und verschieben, wodurch die Gefahr von Personen- oder Sachschäden besteht. NovaBell empfiehlt deshalb, mit einem Fachmann die Verlegeart, die Umgebungsbedingungen und die örtlichen Bestimmungen zu überprüfen und geeignete Lösungen zur Vermeidung jeglichen Risikos anzunehmen.

PREPARATION
For assessments on the type of pedestal (fixed, self-levelling) and the height of the top surface, advice from an expert and/or the pedestal supplier is essential. When calculating the number of pedestals and any edge finishing accessories, bear in mind any offsets and the size of the area for paving in relation to the installation module.

SUBSTRATE
The substrate must be appropriately waterproofed and have a suitable pitch (1.5-2%) and systems for water drainage. The surface must have the strength required to support the concentrated load applied by the pedestals.

INSTALLATION - Position the pedestals in accordance with the optimal installation grid, taking care to adapt the module to the area for paving and avoid perimeter offsets of less than 10 cm. Please refer to the table on page 135.
JOINTS - Pedestals should be arranged with the aid of a spacer which leaves a joint of 2-4 mm between tiles. The open gap created allows rainwater to drain into the cavity underneath.

PRÉPARATION
Pour choisir le type de plots (fixes, autonivelants) et la hauteur de la surface de piétement, il est impératif de s'adresser à un spécialiste et/ou au fabricant des plots. Pour calculer le nombre des plots et des éventuels accessoires nécessaires pour la finition des bords, il convient de tenir compte des déchets produits et de la configuration de la zone à carreler en fonction du module de pose.

SUPPORT DE POSE
Le support de pose doit être correctement imperméabilisé, présenter les inclinaisons nécessaires (1,5-2%) et un bon système de collecte des eaux. La surface de pose doit avoir une capacité de charge appropriée pour résister à la charge ponctuelle des plots.

POSE - Positionner les plots selon le quadrillage optimal déterminé au préalable, en tenant compte de l'adaptation du module à la zone à carreler et en évitant les coupes inférieures à 10 cm sur le périmètre. Nous vous invitons à consulter le tableau page 135.
JOINTS - Les plots sont posés à l'aide d'un croisillon qui laisse un espace de 2-4 mm. Cette distance reste ouverte pour que l'eau de pluie puisse s'écouler dans l'espace technique.

VORBEREITUNG
Für die Wahl des Stelzlagersystems (fest, selbstnivellierend) und der Aufstellungshöhe ist die Beratung durch einen Fachmann und/oder durch den Lieferanten der Stelzlager erforderlich. Bei der Berechnung der Zahl der Stelzlager und des etwaigen Zubehörs für den Randabschluss sind der Verschnitt und die Größe des Verlegebereichs in Abhängigkeit vom Verlegemodul zu berücksichtigen.

UNTERGRUND
Der Untergrund muss entsprechend abgedichtet sein, das notwendige Gefälle aufweisen (1,5-2%) und ein geeignetes Entwässerungssystem besitzen. Die Tragfähigkeit der Fläche muss für die Punktlast der Stelzlager geeignet sein.

VERLEGUNG - Die Stelzlager in einem optimalen Raster unter Anpassung des Moduls an den Verlegebereich positionieren. Randausschnitte von weniger als 10 cm sind zu vermeiden. Bitte schlagen Sie in der Tabelle auf Seite 135 nach.
VERFUGUNG - Die Stelzlager sind mit einem Fugenkreuz für eine Fugenbreite von 2-4 mm ausgerüstet. Die Fuge bleibt offen, so dass das Regenwasser in den Bodenzwischenraum abfließen kann.

TABELLA PER LA POSA SOPRAELEVATA / RAISED INSTALLATION TABLE TABLEAU POUR LA POSE SURÉLEVÉE / TABELLE FÜR DIE VERLEGUNG AUF STELZLAGERN

Formato Size	Altezza fino a 2 cm Up to 2 cm	Supporti al M ² Support's M ²	Altezza da 2 a 10 cm From 2 to 10 cm	Altezza da 10 a 30 cm From 10 to 30 cm
100x100 RET . 39°/6x39°/6	9 piedi 9 supports	4	9 piedi + doppia rete di fibra di vetro o foglio di acciaio zincato 9 supports + double fiberglass mesh or galvanized steel sheets	9 piedi + doppia rete di fibra di vetro o foglio di acciaio zincato 9 supports + double fiberglass mesh or galvanized steel sheets
80x80 RET . 31°/6x31°/6	9 piedi 9 supports	6,25	9 piedi + doppia rete di fibra di vetro o foglio di acciaio zincato 9 supports + double fiberglass mesh or galvanized steel sheets	9 piedi + doppia rete di fibra di vetro o foglio di acciaio zincato 9 supports + double fiberglass mesh or galvanized steel sheets
60x60 RET . 23°/6x23°/6	4 piedi 4 supports	2,78	4 piedi + doppia rete di fibra di vetro o foglio di acciaio zincato 4 supports + double fiberglass mesh or galvanized steel sheets	4 piedi + doppia rete di fibra di vetro o foglio di acciaio zincato 4 supports + double fiberglass mesh or galvanized steel sheets
30x60 RET . 11°/6x23°/6	4 piedi 4 supports	5,56	4 piedi + doppia rete di fibra di vetro o foglio di acciaio zincato 4 supports + double fiberglass mesh or galvanized steel sheets	4 piedi + doppia rete di fibra di vetro o foglio di acciaio zincato 4 supports + double fiberglass mesh or galvanized steel sheets
60x120 RET . 23°/6x47°/6	6 piedi 6 supports	2,78	6 piedi + doppia rete di fibra di vetro o foglio di acciaio zincato 6 supports + double fiberglass mesh or galvanized steel sheets	6 piedi + doppia rete di fibra di vetro o foglio di acciaio zincato 6 supports + double fiberglass mesh or galvanized steel sheets
20x120 RET . 7°/6x47°/6	6 piedi 6 supports	8,33	6 piedi + doppia rete di fibra di vetro o foglio di acciaio zincato 6 supports + double fiberglass mesh or galvanized steel sheets	6 piedi + doppia rete di fibra di vetro o foglio di acciaio zincato 6 supports + double fiberglass mesh or galvanized steel sheets
30x120 RET . 11°/6x47°/6	6 piedi 6 supports	5,56	6 piedi + doppia rete di fibra di vetro o foglio di acciaio zincato 6 supports + double fiberglass mesh or galvanized steel sheets	6 piedi + doppia rete di fibra di vetro o foglio di acciaio zincato 6 supports + double fiberglass mesh or galvanized steel sheets
40x120 RET . 15°/6x47°/6	6 piedi 6 supports	4,17	6 piedi + doppia rete di fibra di vetro o foglio di acciaio zincato 6 supports + double fiberglass mesh or galvanized steel sheets	6 piedi + doppia rete di fibra di vetro o foglio di acciaio zincato 6 supports + double fiberglass mesh or galvanized steel sheets
30x180 RET . 11°/6x70°/6	8 piedi 8 supports	5,56	8 piedi + doppia rete di fibra di vetro o foglio di acciaio zincato 8 supports + double fiberglass mesh or galvanized steel sheets	8 piedi + doppia rete di fibra di vetro o foglio di acciaio zincato 8 supports + double fiberglass mesh or galvanized steel sheets
60x180 RET . 23°/6x70°/6	8 piedi 8 supports	2,78	8 piedi + doppia rete di fibra di vetro o foglio di acciaio zincato 8 supports + double fiberglass mesh or galvanized steel sheets	8 piedi + doppia rete di fibra di vetro o foglio di acciaio zincato 8 supports + double fiberglass mesh or galvanized steel sheets
60x90 RET . 23°/6x35°/6	6 piedi 6 supports	3,7	6 piedi + doppia rete di fibra di vetro o foglio di acciaio zincato 6 supports + double fiberglass mesh or galvanized steel sheets	6 piedi + doppia rete di fibra di vetro o foglio di acciaio zincato 6 supports + double fiberglass mesh or galvanized steel sheets

SOPRAELEVATA CON BARRE PER FORMATI MISTI ✱

RAISED WITH BARS FOR MIXED SIZES

SURÉLEVÉE AVEC BARRES POUR FORMATS MIXTES / AUFGESTELZTE VERLEGUNG MIT METALLSTREBEN FÜR GEMISCHTE FORMATE



IT **AVVERTENZE DI POSA**
Questa soluzione presenta le stesse peculiarità della posa sopraelevata, è quindi necessario per l'installazione e la fattibilità, far riferimento al produttore dei supporti e/o agli installatori specializzati.

EN **IMPORTANT NOTES**
This solution shares the specific characteristics of raised floor installations, so the pedestal manufacturer and/or specialist installers must be consulted with regard to installation and feasibility.

FR **MISES EN GARDE**
Cette solution présente les mêmes particularités que pour la pose surélevée : pour l'installation et la faisabilité, il est donc nécessaire de s'adresser au fabricant des plots et/ou aux installateurs spécialisés.

DE **WARNHINWEISE**
Diese Lösung weist die gleichen Eigenschaften wie die aufgestellte Verlegung auf. Für Installation und Machbarkeit den Hersteller der Stelzlager und/oder Fachinstallateur zu Rate ziehen.

i Grazie ai supporti regolabili con barre metalliche, il sistema permette la posa in sopraelevata per esterni di formati "a doghe" e la combinazione di formati diversi (ad esempio per lastre legno o pietra).

Thanks to the adjustable pedestals with metal bars, the system allows "plank" sizes to be installed as raised pavings outdoors, and the combination of different sizes (for wood or stone slabs, for example).

Grâce aux plots réglables avec barres métalliques, le système permet la pose surélevée pour extérieurs aux formats « à lattes » et la combinaison de formats différents (par exemple pour les dalles bois ou pierre).

Dank der verstellbaren Stelzlager mit Metallstreben ermöglicht das System die aufgestellte Verlegung in Außenbereichen von Formaten im Parkettstil und die Kombination verschiedener Formate (z.B. für Holz- oder Steinplatten).

TAGLIO E MOVIMENTAZIONE / CUTTING AND HANDLING

COUPE ET MANUTENTION / SCHNEIDEN UND HANDHABEN



IT **TAGLIO E FORATURA**
Per tagliare le lastre in gres porcellanato 20mm è necessario impiegare utensili (a secco o ad acqua) con dischi diamantati specifici per gres porcellanato, facilmente reperibili sul mercato.
Per forare le lastre in gres porcellanato 20mm utilizzare punte a tazza specifiche per gres porcellanato.

EN **CUTTING AND DRILLING**
20 mm porcelain stoneware slabs must be cut using wet or dry tools with diamond discs specifically recommended for porcelain stoneware, widely available on the market.
When drilling holes in 20 mm porcelain stoneware, use diamond core bits specifically for porcelain stoneware. In both cases, comply strictly with the instructions provided by the tool, disc and bit producers.



photo RUBI® Tools Italia

FR **COUPE ET PERÇAGE**
La coupe des dalles en grès cérame 20 mm nécessite l'utilisation d'outils (à sec ou à eau) munis de disques diamant pour grès cérame que l'on trouve dans le commerce.
Pour percer les dalles en grès cérame 20 mm, utiliser des scies cloche diamantées pour grès cérame.
Dans les deux cas, respecter scrupuleusement les indications du fabricant des outils et des abrasifs.

DE **SCHNEIDEN UND HANDHABEN**
Schneiden und Bohren
Zum Schneiden der Platten aus Feinsteinzeug 20 mm sind Trocken- oder Nassschneider mit speziellen Diamantscheiben für Feinsteinzeug erforderlich, die problemlos im Fachhandel erhältlich sind.
Zum Bohren der Platten aus Feinsteinzeug 20 mm spezielle Lochsagen für Feinsteinzeug verwenden.
In beiden Fällen sind die Angaben der Hersteller der Werkzeuge und Schleifmittel zu befolgen.



photo La Brevetti Montolit SPA

IT **MOVIMENTAZIONE LASTRE**
Per facilitare la movimentazione delle lastre sono disponibili utensili con maniglia, che permettono di sollevare e muovere le lastre in modo agevole e sicuro.

EN **HANDLING SLABS**
Tools with handles are available for the easy, safe lifting and handling of slabs.

FR **MANUTENTION DES DALLES**
Pour faciliter la manutention des dalles, il existe des outils munis d'une poignée permettant de les soulever et de les déplacer en toute sécurité.

DE **HANDHABUNG DER PLATTEN**
Zur leichteren Handhabung der Platten gibt es Werkzeuge mit Griff, die ein bequemes und sicheres Heben und Bewegen der Platten ermöglichen.

PULIZIA E MANUTENZIONE

CLEANING AND MAINTENANCE

REINIGUNG UND WARTUNG / NETTOYAGE ET ENTRETIEN



IT Per la pulizia dei pavimenti Outwalk 20/30 si consiglia di utilizzare solo acqua e detergente neutro facilitando il drenaggio dell'acqua con una spazzola di gomma

In situazioni di sporco estremo si consiglia l'utilizzo di idropulitrice ad alta pressione.

EN To clean Outwalk 20/30 floors it is recommended to use water and neutral detergent only, facilitating water drainage with a rubber brush

In situations of extreme dirt, we recommend the use of a pressure washer.

FR Pour le nettoyage des sols Outwalk 20/30, il est recommandé d'utiliser uniquement de l'eau et un détergent neutre, facilitant le drainage de l'eau avec une brosse en caoutchouc.

En cas de saleté tenace, nous recommandons l'utilisation d'un nettoyeur haute pression (karcher).

DE Für die Reinigung der Outwalk 20/30-Böden empfehlen wir, nur Wasser und ein neutrales Reinigungsmittel zu verwenden und um den Drainage vom Wasser zu erleichtern, mit einer Gummibürste zu arbeiten.

Bei extremer Verschmutzung wird die Verwendung eines Einscheiben Reinigungsmaschine und stärkeren Reinigungsprodukte empfohlen.

**TABELLA COMPARATIVA
MATERIALE PER L'ESTERNO A
PARITÀ DI FORMA E DIMENSIONI**
COMPARATIVE TABLE OF OUTDOOR
MATERIAL QUALITIES (WITH SAME SHAPE
AND SIZE)

TABLEAU COMPARATIF QUALITATIF DES MATÉRIAUX POUR
EXTÉRIEUR À QUALITÉ ÉGALE DE FORME ET DE FORMATS /
MATERIALIEN FÜR AUSSENBEREICHE IM VERGLEICH (FORM
UND FORMAT GLEICH)

Novabell 20mm porcellanato	Lastre cemento	Lastre pietra naturale	Lastre in calcestruzzo	Legno naturale	Decking wpc (wood plastic composite)
Porcelain stoneware	Concrete slabs	Stone slabs	Reinforced concrete slabs	Natural wood	WPC Decking
Grès cérame	Dalles en ciment	Dalles en pierre naturelle	Dalles en béton	Bois naturel	Terrasses en bois composite
Feinsteinzeug	Betonplatten	Natursteinplatten	Betonsteinpflaster	Naturholz	WPC-Dielen

CROMATISMI E GEOMETRIE
LOOKS AND SHAPES / COULEURS ET MOTIFS GÉOMÉTRIQUES / FARBEN UND GEOMETRIEN

Varietà di colori e look estetici Wide variety of colours and looks / Variété de couleurs et de caractéristiques esthétiques / Vielfalt an Farben und Optiken	★★★★★	★	★★★★	★★	★★	★★★
Elementi d'arredo coordinati Matching furnishings and accessories / Mobilier et accessoires de décoration coordonnés / Abgestimmte Einrichtungselemente	★★★★★	★★★★	★★★★★	★★★	★★★★★	★★★★
Varietà nei formati per esterno Variety of outdoor sizes / Variété des formats pour extérieur / Vielfalt an Formaten für den Außenbereich / Variedad de formatos para exteriores	★★★★★	★★	★★★★★	★★★	★★	★★★
Coordinabilità e continuità con superfici interne Can be matched with indoor floorings / Coordination et continuité visuelle avec les surfaces intérieures / Kombinationsmöglichkeit mit Bodenbelägen für Innenbereiche	★★★★★	★	★★	★	★★★	-
Pezzi speciali per scale e finiture Special trims for stairs and finishes / Pièces spéciales pour escaliers et finitions / Formteile für Treppen und Oberflächen	★★★★★	★★	★★★★★	★	★★★★★	★★★★
Regolarità dimensionale Constant dimensions / Régularité dimensionnelle / Maßhaltigkeit	★★★★★	★★★★	★★★★★	★	★★★★	★★★★

RESISTENZA MECCANICA DELLE LASTRE
MECHANICAL STRENGTH / RÉSISTANCE MÉCANIQUE DES DALLES / MECHANISCHE BELASTBARKEIT DER PLATTEN

Resistenza alla flessione Breaking strength / Résistance à la flexion / Biegefestigkeit	★★★★★	★★	★★★★	★	-	-
Resistenza allo schiacciamento Resistant to crushing / Résistance à l'écrasement / Druckfestigkeit	★★★★★	★★★	★★★★	★★★	-	-
Compattezza Compact / Compacité / Dichte	★★★★★	★★★	★★★★	★	-	★★★
Resistenza ai carichi in movimento (carrabilità)* Drive-over for cars / Résistance aux charges en mouvement (carrossable)* / Befahrbarkeit *con solidarizzazione al sottofondo / *with solid bond to substrate / *avec solidarisation au support de pose / *Befestigung am Untergrund	★★★★	★★★	★★★★★	★★★★★	-	-

RESISTENZA CHIMICO/FISICA DELLE SUPERFICI
CHEMICAL/PHYSICAL RESISTANCE OF SURFACE / RÉSISTANCE PHYSICO-CHIMIQUE DES SURFACES / CHEMISCHE/PHYSIKALISCHE BELASTBARKEIT OBERFLÄCHEN

Resistenza al graffio Scratch resistant / Résiste aux rayures / kratzunempfindlich	★★★★★	★★★	★★★★	★★	★	-
Resistenza allo sfondamento Load bearing capacity / Résistance à la charge de rupture / Bruchkraft	★★★★★	★★★★	★★★★★	★★★	★	-
Resistenza all'abrasione profonda Resistant to deep abrasion / Résistance à l'abrasion profonde / Beständigkeit gegen Tiefenverschleiß	★★★★★	★★★	★★★★	★★★	★	-
Resistenza agli agenti chimici forti Resistant to strong chemicals / Résistance aux agents chimiques forts / Beständigkeit gegenüber starken Chemikalien	★★★★★	★★	★★★★	★★★	★	-
Resistenza ai solventi / carburanti / grassi Resistance to solvents/fuels/greases / Résistance aux solvants/carburants/corps gras / Beständigkeit gegen Lösemittel/Brennstoffe/Fette	★★★★★	★★	★★★★	★★★	★	-
Resistenza alle azioni chimico / meccaniche (idropultrici) Power jet cleaners and strong detergents can be used / Résistance aux actions chimiques/mécaniques (nettoyage haute pression) / Beständigkeit gegen chemische/ mechanische Belastung (Hochdruckreiniger)	★★★★★	★★★★	★★★★★	★★★	★	-
Resistenza alla penetrazione di sporco Resistant to stains / Résistance à la pénétration de la saleté / Schmutzunempfindlichkeit	★★★★★	★★	★★★★	★★	★	★★★★

**TABELLA COMPARATIVA
MATERIALE PER L'ESTERNO A
PARITÀ DI FORMA E DIMENSIONI**
COMPARATIVE TABLE OF OUTDOOR
MATERIAL QUALITIES (WITH SAME SHAPE
AND SIZE)

TABLEAU COMPARATIF QUALITATIF DES MATÉRIAUX POUR
EXTÉRIEUR À QUALITÉ ÉGALE DE FORME ET DE FORMATS /
MATERIALIEN FÜR AUSSENBEREICHE IM VERGLEICH (FORM
UND FORMAT GLEICH)

Novabell 20mm porcellanato	Lastre cemento	Lastre pietra naturale	Lastre in calcestruzzo	Legno naturale	Decking wpc (wood plastic composite)
Porcelain stoneware	Concrete slabs	Stone slabs	Reinforced concrete slabs	Natural wood	WPC Decking
Grès cérame	Dalles en ciment	Dalles en pierre naturelle	Dalles en béton	Bois naturel	Terrasses en bois composite
Feinsteinzeug	Betonplatten	Natursteinplatten	Betonsteinpflaster	Naturholz	WPC-Dielen

RESISTENZA AGLI STRESS CLIMATICI
RESISTANT TO CLIMATE STRESSES / RÉSISTANCE AU STRESS CLIMATIQUE / BESTÄNDIGKEIT GEGEN WITTERUNGSEINFLÜSSE

Resistenza a funghi e muffe Resistant to fungus and moulds / Résiste aux champignons et aux mousses / Schimmel- und pilzbeständig	★★★★★	★★★	★★★★	★★★	★	★★★
Resistenza ai ristagni d'acqua e fango Resistant to standing water and mud / Résiste à la stagnation d'eau et de boue / Beständig gegen Staunässe und Schlamm	★★★★★	★★★★	★★★★★	★★★★	★	★★★★
Resistenza alle basse temperature e al gelo Resistant to low temperatures and frost / Résiste aux basses températures et au gel / Kälte- und frostbeständig	★★★★★	★★★★	★★★★	★★★★	★★★	★★★★★
Resistenza al calore Resistant to heat / Résiste à la chaleur / Hitzebeständig	★★★★★	★★★★	★★★★★	★★★★★	★★★★	★★
Resistenza agli sbalzi termici Resistant to thermal shock / Résiste aux amplitudes thermiques / Vielfalt an Formaten für den Außenbereich	★★★★★	★★★★	★★★★	★★★★★	★★★★★	★★★
Resistenza ai raggi UV UV-resistant / Résiste aux rayons UV / UV-beständig	★★★★★	★★★★★	★★★★★	★★★★★	★★	★★★★
Colori stabili nel tempo Colours stable over time / Couleurs stables dans le temps / Dauerhafte Farblichkeit	★★★★★	★★★★	★★★★★	★★★★	★★	★★★

SOSTENIBILITÀ E SICUREZZA
SUSTAINABILITY AND SAFETY / DÉVELOPPEMENT DURABLE ET SÉCURITÉ / NACHHALTIGKEIT UND SICHERHEIT

Contenuto e cessione di sostanze tossiche/nocive per le persone e l'ambiente Contents and transfer of substances toxic/harmful for people and the environment / Contenu et dégagement de substances toxiques/nocives pour les personnes et l'environnement / Gehalt und Freisetzung giftiger/schädlicher Stoffe für die menschliche Gesundheit und Umwelt	★★★★★	★★★	★★★★★	★★★	★★★★	★★★
Produzione e cessione di polveri e materiale particolato Production and transfer of dust and fine particles / Production et dégagement de poudres et matériaux en particules / Erzeugung und Freisetzung von Stäuben und Partikeln	★★★★	★★★	★★★	★★	★★★★	★★★★
Reazione al fuoco Reaction to fire / Réaction au feu / Brandverhalten	★★★★★	★★★★	★★★★★	★★★★	-	-
Allergenicità Allergenic potential / Allergénicité / Allergenität	★★★★★	★★★	★★★★★	★★★	★★★	★
Reazione allo scivolamento Antislip properties / Résistance à la glissance / Rutschhemmung	★★★★★	★★★★★	★★★★★	★★★★★	★★★	★★★
Riutilizzabilità Reusability / Réutilisable / Wiederverwertbarkeit	★★★★★	-	★★★★★	★★★★	★★★★	★★★★★
Smaltimento Disposal / Gestion des déchets / Entsorgung	★★★★★	★★	★★★★★	★★	★★★★★	-

LEGENDA STELLE
KEY TO STARS / LÉGENDE ASTÉRISQUES / STERNEBEWERTUNG

★★★★★	★★★★	★★★	★★	★	-
Prestazione ottimale Excellent Performance eccellente Ausgezeichnet	Buona Good Bonne Gut	Discreta Fair Satisfaisante Mäßig	Scarsa Poor Insuffisante schlecht	Molto scarsa Very poor Très insuffisante sehr schlecht	Prestazione non nota o non possibile Not know or not possible performance non connue ou impossible nicht bekannt oder nicht anwendbar

DATI TECNICI TECHNICAL FEATURES

TECHNISCHE EIGENSCHAFTEN
CARACTERISTIQUES TECHNIQUES

Water absorption ≤ 0,03 %	Antislip		Mohs ≥ 8
	R11	A+B+C	
Modulus of rupture	≥ 50 N/mm ²	≥ 500 Kg/cm ²	≥ 7,500 psi
Breaking strength (for square slabs)	≥ 12.000 N	≥ 1.200 Kg	≥ 2,700 Lbs
Compressive strength	≥ 200 N/mm ²	≥ 2.000 Kg/cm ²	≥ 29,000 psi
Color resistance UV light	Resistant	Reaction to fire	A1FL
Frost resistance	Complies	Thermal shock	Resistant

The international reference standards: ISO - EN

The values of the main technical characteristics measured on our products, compared with international standards, are clearly shown and reproduced on our contractual documents (catalogs, price lists, etc.). The values given in this document are common to groups of articles or series of our tiles and therefore are to be used as a guide for a first orientation in choosing the product. If required, the specific values for a given product and a determined supply can be provided depending on its intended use, when formally brought to our attention by notice in writing.

Characteristics and Test methods	Requirements EN 14411 ⁽¹⁾ - G/ISO 13006 ⁽²⁾ - G	Our general values
Determination of water absorption (ISO 10545-3)	Average value $E_w \leq 0,5\%$ / Individual maximum $\leq 0,6\%$	$\leq 0,03\%$ Average value and individual maximum
Classification	Definition § 3.2 and § 3.7	BI_A - Porcelain tiles
20 mm Physical properties		Physical properties
Modulus of rupture (ISO 10545-4)	Average ≥ 35 N/mm ²	≥ 50 N/mm ²
Breaking strength - (ISO 10545-4)	Average ≥ 1300 N for thickness $\geq 7,5$ mm Average ≥ 700 N for thickness $< 7,5$ mm	Complies
Flexion resistance and breaking load - (EN 1339-F) P-Average Breaking Strength T-Average of modulus of rupture	Classes according to EN 1339 - § 5 (3)	$\geq U11$ ≥ 12.000 N ≥ 50 N/mm ²
Compressive strength (cubic sample 2 cm side)	NA	≥ 200 N/mm ²
MOHS hardness scale (ex EN 101 / BS 6431-13)	NA	≥ 8
Resistance to surface abrasion (ISO 10545-7)	Abrasion class and cycles passed	Class 0-5
Resistance to deep abrasion (ISO 10545-6)	Max volume abraded < 175 / mm ³	< 130 / mm ³
Raccomanded use	Novabell criterion	Class 5 (see Annex N-ISO 13006 / EN 14411)
Color resistance to UV light (Din 51094)	...	Resistant
Coefficient of linear thermal expansion (ISO 10545-8)	Declared value ⁽¹⁾ / Test method available ⁽²⁾	$< 7,1 \times 10^{-6} \text{ } ^\circ\text{C}^{-1}$
Thermal shock resistance (ISO 10545-9)	Pass according to EN ISO 10545-1 ⁽¹⁾ / Test method available ⁽²⁾	Complies
Crazing resistance (ISO 10545-11)	Pass according to EN ISO 10545-1 ⁽¹⁾ / Required ⁽²⁾	Complies
Frost resistance (ISO 10545-12)	Pass according to EN ISO 10545-1 ⁽¹⁾ / Required ⁽²⁾	Complies
Moisture expansion (ISO 10545-10)	Declared value ⁽¹⁾ / Test method available ⁽²⁾	$\leq 0,1$ mm/m
Small colour differences (ISO 10545-16)	ΔE_{cmc} da $< 0,75$ a $< 1,0$ (1)	If agreed
Impact resistance (ISO 10545-5)	Declared value ⁽¹⁾ / Test method available ⁽²⁾	COR $> 0,75$
Reaction to fire	Class A1 or A1 _{FL} ⁽¹⁾	A1_{FL} Classified Without Testing (CWT) - 96/603 EC
20 mm Chemical properties		Chemical properties
Chemical resistance - (ISO 10545-13)		
Resistance to low and high concentrations of acids and alkalis	Declared value ⁽¹⁾ / Manufacturer is to state classification ⁽²⁾	Resistant (see "Maintenance and care" section)
Resistance to household chemicals and swimming pool salts	Minimum class B	A
Resistance to staining (ISO 10545-14)	Minimum class 3	5 (see "Maintenance and care" section)
Release of dangerous substances (ISO 10545-15)	Declared value ⁽¹⁾ / Test method available ⁽²⁾	Pb $< 0,1$ / Cd $< 0,01$ mg/dm ²
20 mm Dimensions and surface quality		Dimensions and surface quality
Dimensions (ISO 10545-2)	See ANNEX G	Complies
Surface quality - (ISO 10545-2 § 7)	A minimum of 95% of the tiles shall be free from visible defects that would impair the appearance of a major area of tiles	Complies

(1) Requirements according to EN 14411 (2) Requirements according to ISO 13006 (3) This classification is not an indication of the intended use of NF 187 for concrete slabs

Test methods	Requirements and references	Our general values
DIN 51130	BGR / ASR From R9 to R13	R11
DIN 5109	GUV-I 8527 A - B - C	A + B + C
BCR - ex BCRA	DM n. 236 / 1989 $\mu > 0,40$	$\mu > 0,40$
DCOF Resistance (ANSI A 137.1 Section 9.6)	$\geq 0,42$ ⁽¹⁾	DCOF $\geq 0,42$

North America reference standards: ANSI - ASTM

The values of the main technical characteristics measured on our products, compared with international standards, are clearly shown and reproduced on our contractual documents (catalogs, price lists, etc.). The values given in this document are common to groups of articles or series of our tiles and therefore are to be used as a guide for a first orientation in choosing the product. If required, the specific values for a given product and a determined supply can be provided depending on its intended use, when formally brought to our attention by notice in writing.

09315
PORCELAIN
TILE

Characteristics and Test methods	Requirements ANSI A 137.1	Our general values
Determination of water absorption - (ASTM C 373)	Average value $E_w \leq 0,5\%$	Average value $\leq 0,03\%$
Classification	Definition § 3.0	Porcelain tiles
		Physical properties
Breaking strength - (ASTM C 648)	Average ≥ 250 lbf (1.11 kN) Individual ≥ 225 lbf (1.00 kN)	Complies
Visible Abrasion - (ASTM C 1027)	As reported	See the specific section
Thermal shock resistance - (ASTM C 428)	Pass	Complies
Crazing resistance - (ASTM C 424)	Pass	Complies
Resistance to freeze/thaw cycling - (ASTM C 1026)	As reported	Resistant
DCOF Resistance - (ANSI A 137.1 Section 9.6)	$\geq 0,42$ ⁽¹⁾	DCOF $\geq 0,42$
Bond strength - (ASTM C 482)	≥ 50 psi (0.34 MPa)	> 1 MPa
Color Uniformity - (ASTM C 609 and ANSI A 137.1 section 9.3) ⁽²⁾	V0 - 3 Juds	See the specific section
		Chemical properties
Chemical resistance - (ASTM C 650)	As reported	Resistant
Stain resistance - (ASTM C 1378)	As reported	Resistant
		Dimensions - Calibrated tiles
Dimensions - (ASTM C 499) - (ASTM C 485) - (ASTM C 502)	See ANSI A 137.1 - Tab.10	Complies
		Dimensions - Rectified tiles
Dimensions - (ASTM C 499) - (ASTM C 485) - (ASTM C 502)	See ANSI A 137.1 - Tab.10	Complies

(1) For level interior spaces expected to be walked upon when wet - (2) For V0 tiles only

La tabella in italiano con i dati tecnici è scaricabile su www.novabell.it

Si vous le souhaitez, téléchargez le tableau contenant les données techniques en français en allant sur www.novabell.it

The English language technical specification for each collection can be downloaded from www.novabell.it

Die Tabelle in deutscher Sprache kann auf www.novabell.it heruntergeladen werden.

CERTIFICAZIONI E SOSTENIBILITA' / CERTIFICATIONS AND SUSTAINABILITY CERTIFICATIONS ET DÉVELOPPEMENT DURABLE / ZERTIFIZIERUNGEN UND NACHHALTIGKEIT



CARREAUX
CERAMIQUES
POUR
REVÊTEMENTS
DE SOL

La liste à jour des
matériaux NovaBell
certifiés UPEC est disponible
sur le site internet
www.cstb.fr

Le classement QB UPEC est une certification de produit volontaire issue par le laboratoire français CSTB. Il vérifie la qualité, la performance et la fiabilité des carreaux céramiques par rapport à la destination d'usage.



UPEC INDOOR



UPEC OUTDOOR

ESPOSITORI 20MM



cod. **ESP2CM3NDW** cod. **ESP23PS** cod. **ESP2CM23** cod. **ESP23CM60**



cod. **ESP2CM2NDW** cod. **ESP23PS** cod. **ESP2CM24** cod. **ESP23CM60**



cod. **ESP2CMPPOOL** cod. **ESP2CMBOIS** cod. **ESP2CM22PIERRE** cod. **ESP23CM22**
cod. **ESPBRAND** cod. **ESPBRAND**



cod. **SCALA4X30**



cod. **MUROCOPX**

PEDANE PER ESTERNO



cod. **PAL2CM185** cm.180x100x16H



cod. **PAL2CM100** cm.120x200x20H



cod. **PAL2MLT** cm.120x160x16H



cod. **PAL2CMA** cm.80x160x16H



cod. **FLD20MM2**



cod. **FLD20MM1**



cod. **CHIPSBOX**

STRUTTURE IN METALLO COMPONENTI E MODULARI PER ESTERNO



cod. **PAN2CM-PS**



cod. **EXT2CM2**
100x220cm. x2



cod. **EXT2CM1**
100x220cm.

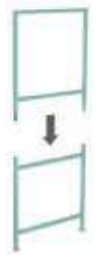

cod. **EXT2CM3**
100x220cm.



cod. **PAN2CM-A3**



cod. **PAN2CM-C3**



cod. **PAN2CM-E3**



cod. **PAN2CM-G3**



cod. **PAN2CM-I3**



cod. **PAN2CM-M3**



cod. **PAN2CMUPEC-A**



cod. **PAN2CM-B3**



cod. **PAN2CM-D3**



cod. **PAN2CM-F3**



cod. **PAN2CM-H3**



cod. **PAN2CM-L3**



cod. **PAN2CM-PS**



cod. **PAN2CMUPEC-B**

CORNER 20MM

CORNER A 480x320 cm



STANDARD AREA DIMENSION 15,36 M²

CORNER B 240x360 cm



STANDARD AREA DIMENSION 8,64 M²

CORNER C 160x360 cm



STANDARD AREA DIMENSION 5,76 M²

GUIDA ALLA CONSULTAZIONE

CONSULTATION GUIDE / GUIDE DE CONSULTATION / NACHSCHLAGEHILFE

INDICAZIONE TIPOLOGIA

Product type / Product type / Indication de la typologie / Typenangabe

09315
PORCELAIN
TILE

Gres porcellanato
Glazed porcelain
Feinsteinzeug
Gres cerame



Alta definizione
High definition
Hohe auflösung
Haute definition



Antislip
Anti-slip
Rutschfest
Anti-derapant



Prodotto ecologico
Environment-friendly product
Umweltfreundliches produkt
Produit écologique



Spessore 20mm/30mm
Thickness 20mm/30mm
Verstärkte 20mm/30mm
Épaisseur 20mm/30mm



Per scaricare informazioni tecniche/cataloghi
To download technical information/catalogues
Download von technischen daten/katalogen
Pour télécharger les informations techniques/catalogues

CARATTERISTICHE TECNICHE

Technical features / Caracteristiques techniques / Technische eigenschaften



DIN EN 16165 ANNEX A - B
BCR - DCOF
Resistenza alla scivolosità
Slip resistance
Rutschfestigkeit
Capacite antiderapante



Resistente agli acidi
Acid resistant
Säurefestigkeit
Resistant aux acides



Resistenza al gelo
Frost resistance
Frostbeständigkeit
Resistance au gel

ASPETTO DELLA SUPERFICIE - ANSI A 137.1

Surface aspect / Aspect de la surface / Aussehen der oberfläche



Aspetto uniforme
Uniform appearance
Einheitliches aussehen
Aspect uniforme



Lieve variazione
Slight variation
Geringe abweichung
Legere variation



Moderata variazione
Moderate variation
Mässige abweichung
Variation moderee



Forte stonalizzazione
Substantial variation
Akzentuierte variation
Effet de nuance tres accentuee

LEED® COMPLIANT

Le collezioni **NOVABELL OUTDOOR** sono state certificate dall'istituto **BUREAU VERITAS** come conforme al sistema di valutazione **LEED®** per lo sviluppo di edifici "verdi" promosso dallo United States Green Building Council.

The **NOVABELL OUTDOOR** collections have been certified by **BUREAU VERITAS** as compliant with the **LEED®** rating system for the development of **GREEN BUILDINGS**, promoted by the United States Green Building Council.

MR Credit 4.1 - 4.2

EQ Credit 4.2

ID Credit 1.1 - 1.4

EA Credit 1

MR Credit 5.2

SS Credit 7.1



Product Certification
BUREAU VERITAS
Certification



LISTINO PREZZI

PRICE LIST / LISTE DE PRIX / PREISLISTE

PRICE BAND	Euro / Pcs
130	2,20
150	3,20
160	4,20
170	5,20
200	6,50
220	8,50
230	9,15
240	10,15
250	11,15
260	12,75
290	15,50
310	17,50
330	19,50
350	21,50
360	23,50
380	25,50
400	27,50
410	29,50
430	31,50
470	33,50
490	35,50
492	37,50
495	39,50
505	41,50
507	43,50
518	45,50
520	47,50
530	49,50
540	51,50
560	53,50
570	55,50

PRICE BAND	Euro / Pcs
580	57,50
590	59,50
603	61,50
607	63,50
610	65,50
620	67,50
625	69,50
627	71,50
632	73,50
640	75,50
645	82,50
650	85,50
652	91,50
654	96,50
656	98,50
662	106,50
664	115,50
665	127,50
667	139,50
670	148,50
672	160,50
674	172,50
676	184,50
678	200,50
680	218,00
681	238,50
682	260,50
683	280,00
684	300,00
685	340,00
686	370,00

PRICE BAND	≥ Pallet Euro / Mq
1000	31,50
1005	33,00
1010	35,50
1015	38,50
1020	42,50
1025	44,50
1030	46,50
1035	48,50
1040	50,50
1045	53,00
1050	55,00
1055	57,50
1060	59,50
1065	62,00
1070	64,00
1075	67,00
1080	70,00
1085	72,00
1090	75,00
1095	77,00
1100	82,00
1105	85,00
1110	91,00
1115	96,00
1120	100,00
1125	105,00
1130	110,00
1135	115,00
1140	120,00
1145	125,00
1150	131,00
1155	137,00
1160	143,00
1165	150,00

0000

ARANCIO = FASCIA DI PREZZO INTESO AL M2
ORANGE = OF THE PRICE BAND PER SQ.M.
ORANGE = NUMERO FOURCHETTE DE PRIX PAR M2
ORANGE = PREISZONENNUMMER PRO QUADRATMETER

000

GRIGIO = NUMERO FASCIA DI PREZZO INTESO AL PEZZO O ALLA COMPOSIZIONE
GRAY = NUMBER OF THE PRICE BAND PER PIECE OR COMPOSITION
GRIS = NUMERO FOURCHETTE DE PRIX PAR PIECE OU PAR COMPOSITION
GRAU = PREISZONENNUMMER PRO STÜCK ODER ZUSAMMENSTELLUNG

Attenzione! Tutti i prodotti/articoli sono venduti solo a scatole intere.

Please note that these products/items can be purchased only by the boxful.

Attention ! Tous les produits/articles sont vendus à la boîte entière.

Hinweis zur Beachtung! Alle Produkte/ Artikel werden nur in kompletten Kartons verkauft.



cod. Pkt2cm2223



NOVABELL SpA CERAMICHE ITALIANE
via Molino, 1 - 42014 Roteglia (RE), Italia
T +39 0536 86 11 11 - F +39 0536 85 12 05
info@novabell.it - export@novabell.it
www.novabell.it

